



**Cup Quizzer**  
details page 67

INSPIRATION IN EDUCATION



## Dear customers,

2020 was a challenging year for all of us. We hope that you have come through this difficult phase well. We are happy to remain your reliable partner who is taking care of your needs and belongings also in the future.

In order to ensure and intensify this support we worked on 2 important projects in 2020. We were able to finalise our new warehouse system in January 2021. The highly modern system helps us to arrange faster deliveries. The restructuring has caused some delays in autumn 2020, for which we would like to apologize. Due to the new challenge "Homeschooling" in schools and kindergartens, digitalization got even more important during the past months and probably will also be in the future.

Betzold has taken the chance to establish a comfortable B2B-Shop in addition to our current product catalogue. Profit from the following advantages by visiting our website **[www.betzold-educational.com](http://www.betzold-educational.com)**:

- › Access to the complete retail range of about 9.000 products of Betzold
- › Simple function for searching products in the complete range
- › Advertising of novelties, sales promotion or interesting product information
- › View of availability of products and estimated delivery time (if not in stock)
- › Notification of YOUR purchasing price plus the RRP of the manufacturer
- › Information where to download pictures, manuals and documents.
- › All relevant product information at a glance
- › Simply use your excel orders for direct import into B2B-Shop and get direct availability information
- › Own customer account with order history (beginning from the start of the B2B-Shop)

Betzold is ready to continue to be **YOUR** reliable partner in the future and we look forward to working with you. Should you have any questions, please do not hesitate to contact us.

Yours sincerely

*Ulrich Betzold*

Ulrich Betzold

**Betzold Educational GmbH**  
Ferdinand-Porsche-Str. 6  
73479 Ellwangen  
Germany

phone: +49 7961 - 9258 - 10  
fax: +49 7961 - 9258 - 20  
[www.betzold-educational.com](http://www.betzold-educational.com)  
[info@betzold-educational.com](mailto:info@betzold-educational.com)



## PRETEND PLAY

4 - 45



## MONTESSORI

46 - 53



## LANGUAGE

54 - 65



## MATHEMATICS

66 - 125



## SCIENCE

126 - 161



## MUSIC

162 - 177



## ARTS & CRAFTS

178 - 191



## SPORTS & GAMES

192 - 229



## TEACHER RESOURCES

230 - 273

# PRETEND PLAY



## DEVELOPMENT:

- SELF-CONFIDENCE AND SELF-AWARENESS
- MOTION EXERCISE AND HANDLING
- NUMBERS AND SHAPES
- RHYTHM AND HAND-EYE COORDINATION

## Wall Panels – Set of 6

The set of six wall panels – each with different manipulative activities – encourages hand-eye coordination and fine motor skills. The set includes: percussion instruments, a number game, a stacking puzzle, a sliding puzzle, rotational pieces and a line-following maze. The different games offer a wide range of hands-on problem solving and learning opportunities to develop fine motor skills.

Each piece comes with fixing holes and mounting screws for easy wall mounting.

Dimensions (L x H x W): 35 x 33 x 1.5 cm

Material: wood

Age: 24 M+

756307V90



### Wooden Seat Group, 4 pieces

The seat group is made of stable rubber plant wood. Two stools and a bench can accommodate up to 4 children. The seat group is the ultimate, space-saving solution for all common rooms: the 4 pieces of furniture can easily be pushed together until the next use. The plain surfaces can be wiped off with a damp cloth to clean the furniture. Due to the rounded corners there is no risk of injury for the children.

#### Content:

- › 2 stools (26 x 30 x 30 cm)
- › 1 bench (32 x 70 x 30 cm)
- › 1 table (48 x 80 x 40 cm)
- › assembly instructions

**757940V90**



MADE OF SOLID  
RUBBER WOOD



### Table and Chairs Set

Art projects, tea parties and snack time are all the more fun with this 3 piece table and chairs set. The set is exclusively designed for children. It is easy to assemble and the sturdy table and chairs are great for boys and girls ages 3 years and up.

For easy self-assembly

Capacity up to 90 kg

Dimensions:

chair (H x W x D): 53.5 x 26 x 26.5 cm, seating height:

26 cm, table (H x W x D): 48.5 x 56 x 52 cm

Material: pinewood, plywood

**Content:** 2 chairs, 1 table

Comes flat packed

**756010V90**



### Wooden Christmas Crib

Wonderful playset for Christmas. Includes Baby Jesus with crib, Mary and Joseph, the Three Kings, angel, shepherd, sheep, camel, donkey, palm tree, stable with star.

Size of the figures: 6 to 9 cm;

Size of the stable: 23 x 11 x 16 cm

Warning Notice: 1 (page 271)

**43318V90**





**Wooden Maze**

Wooden mini toy that improves the skill of hand movement. Each toy comes with 4 balls to be maneuvered into the specified pinholes.

Diameter: 57.5 cm  
Warning Notice: 5 (page 271)

**756624V90** Set of 24



**Wooden Tops**

Multi-coloured wooden spinning tops available in 6 colourful designs. The display box contains 12 spinning tops, 2 each in the same design.

Diameter: 5 cm  
Warning Notice: 1 (page 271)

**756625V90** Set of 12



**Colourful Chunky Wooden Yoyos**

Comes in 6 colours: yellow/cow, orange/giraffe, red/lion, pink/rabbit, green/monkey and blue/zebra  
Dimensions: diameter: 5.5 cm, length of twine: 125 cm  
Warning Notice: 4 (page 271)

**756623V90** Set of 12

**PUZZLE FUN**



**Wooden Puzzle Bee**  
**756631V90**

**Wooden Puzzle Butterfly**  
**756629V90**

**Wooden Puzzle Ladybug**  
**756633V90**



**Wooden Puzzle Turtle**  
**756635V90**

**Wooden Puzzle Crab**  
**756637V90**

**Wooden Puzzle Fish**  
**756636V90**

**Wooden Jigsaws**

Beautiful flat puzzles with the images of different animals. The flat puzzles can stimulate the logical thinking of children at their early stage.

Age: 12 M+  
Dimensions (H x W x D): 22.5 x 22.5 x 1 cm

**Big Wooden Knob Puzzle Insects**  
**756627V90**

**Big Wooden Knob Puzzle Under Water**  
**756628V90**

**Great for Puzzle Beginners**

Classic flat puzzles with the puzzle fitting into the base. Develops shape and colour recognition and matching and improves reasoning and hand-eye coordination.

Each puzzle consists of 4 large pieces.  
Age: 18 M+  
Dimensions: 13 x 10 cm

### Wooden Rainbows

Wooden parts with rounded corners and natural wood structure. Promotes sensory perception.

#### Rainbow, small

6 wooden parts  
Dimensions (H x W x D): 16.2 x 19.1 x 6.3 cm  
Material: Wood  
Age: 18 M+  
**762204V90**

#### Rainbow, large

Dimensions (H x W x D): 16.2 x 32.4 x 6.3 cm  
Material: Wood  
Age: 18 M+  
**762203V90**

#### Rainbow Clouds, Set of 11

11 colourful cloud shaped plates made from high quality wood with a natural structure. Ideal for playing, building and sorting games.  
Dimensions biggest cloud (H x W x D): 19 x 36 x 0,8 cm  
Material: Wood  
**759652V90**



### Wooden Rainbows

Wooden parts, glazed with different water colours. Rounded corners and natural wood structure. Promotes sensory perception.

#### Rainbow, small

6 wooden parts  
Dimensions (H x W x D): 16.2 x 19.1 x 6.3 cm  
Material: Wood  
Age: 18 M+  
**758986V90**

#### Rainbow, large

Dimensions (H x W x D): 16.2 x 32.4 x 6.3 cm  
Material: Wood  
Age: 18 M+  
**758985V90**

### Sound Blocks

The set of sound blocks features wooden squares, rectangles and circles. Each is filled with wooden beads so they make different sounds while being shaken.

- › Includes 12 beautifully crafted wooden blocks in a variety of shapes and colours.
  - › The wooden blocks make 9 different sounds.
  - › No batteries required.
- Age: 12 M+

**756622V90**



TIME TO  
PLAY

Minimum order: € 400,-



**Beautiful Doll House**

A house, which offers plenty of space on two levels, open on all four sides. This enables several children to play at the same time. Easy to assemble.  
 Size (W x H): 61 x 60 cm, weight: 7.2 kg  
 Made from coated MDF  
 Age: 18 M+. Delivery without decoration.  
 Warning Notices: 12, 16 (page 271)  
**56377V90**



HOME FOR FAMILIES ...



... AND KNIGHTS

**Large Wooden Castle**

This wooden castle features 4 corner towers, 4 side walls – one with a drawbridge – 2 flags and 1 ladder. It is freestanding (no baseboard) and very easy to assemble.  
 Dimensions (H x W x D): 38 x 62 x 60 cm  
 Warning Notice: 1 (page 271)

**51680V90**





### Knights' Castle

Watch your children play and engage in a wonderful world of adventure and role play. This jumbo play castle can also be used as a fortress. Whether set up in a row or as a fortification, various formations guarantee hours of fun. Features four watch towers to keep a watchful eye on enemies far away and three walkways for guard patrol. The guard on duty decides who is allowed through the gate. Delivery without decoration.

Dimensions:

tower (H x W x D): 61.5 x 22 x 22 cm

battlement (H x W x D): 36 x 45 x 22 cm

#### Content:

- › 4 towers
- › 4 battlements
- › medieval fun for young and old
- › perfect for role play
- › can be configured in multiple ways
- › made from high-quality MDF
- › for easy self-assembly

Warning Notice: 1 (page 271)

**754574V90**

ALL KIDS LOVE FIGHTING DRAGONS,  
BATTLING WITH SWORDS OR  
DANCING WITH FAIRIES

# DINNER IS SERVED!



## Tableware

... and dinner is served!  
20 parts. Cups and plates made of non-sticking plastic, cutlery made of plastic.

## Content:

4 cups, 4 plates, 4 forks, 4 spoons, 4 napkins  
Warning Notice: 1 (page 271)

**51670V90**



## Kiddy Oven Mitts

The perfect outfit for little cooks!  
2 gloves, 13 x 18 cm  
Warning Notices: 1, 8, 14 (page 271)  
**51672V90**



## Kiddy Apron

A must for little chefs!  
53 x 44 cm  
Warning Notices: 4, 14 (page 271)  
**51671V90**



# TOY KITCHEN FOR TODDLERS



## Toy Kitchen for Toddlers

This child sized toy kitchen is designed for the youngest chefs and invites children from 1 to 4 years of age to try to cook for themselves. The kitchen consists of one module which includes stove and sink.

Dimensions (H x W x D): 38.5 x 75.5 x 38 cm  
Weight: 14.2 kg  
Material: MDF and beech wood, coated  
Age: 12 M+  
Warning Notice: 12 (page 271)

**56136V90**

**Table-Tent**

With the blink of an eye tables can be transformed into a tent. Children will love to play in this fun house and create a comfortable and cosy home. With this accessory, you can really strike home!

- › For all tables 120 x 80 cm, height: 52 cm
- › Door-curtains, to be kept open by hook-and-loop fastener
- › 2 folding windows, to be closed by hook-and-loop fastener
- › Made of solid fabric, 100% polyester, machine washable at 30 °C, delicate cycle

Age: 24 M+

Warning Notice: 14 (page 271)



**Table Tent, Dots**  
58813V90



**Table Tent, Triangles**  
758484V90



# TOY KITCHEN



## Toy Kitchen

Children will be delighted to create special recipes with this large toy kitchen set. This set features 5 pieces of equipment. Complete with stove, refrigerator, microwave, sink and washing machine.

Ergonomical kid-friendly counter-top provides food prep and dishwashing area. Features turning knobs and acrylic windows on appliance doors.

### Dimensions (H x W x D):

**Cooker/Stove:** 53.5 x 40 x 34 cm

**Sink:** 53.5 x 40 x 34 cm

**Washing machine:** 53.5 x 40 x 34 cm

**Refrigerator:** 79 x 40 x 34 cm

**Microwave:** 24.5 x 36 x 28 cm

Material: MDF and beech wood, coated

Comes flat packed

Age: 24 M+

Warning Notice: 12 (page 271)

**54989V90**



## Washing Machine

Warning Notice: 12 (page 271)

**56689V90**



## Stove

Warning Notice: 12 (page 271)

**56688V90**



## Sink

Warning Notice: 12 (page 271)

**56692V90**



## Kitchen Side Shelf

A great piece that provides the extra storage every kitchen needs. It can be attached to any part of the toy kitchen and takes up hardly any space. By placing four kitchen shelves together, you can easily create a fashionable kitchen island for additional cooking and storage space.



Dimensions (H x W x D): 53 x 47 x 24 cm

Material: MDF and beech wood, coated

Age: 24 M+

All Warning Notice: 12 (page 271)

**754435V90** Single

**754556V90** Set of 4



### Kitchen Shelf with Counter Top

Makes the children's kitchen complete: Add extra working space and flair to your toy kitchen by installing a kitchen block. The shelves provide a lot of storage space for cooking utensils.

Dimensions (H x W x D): 53 x 58 x 34 cm

Material: MDF and beech wood, coated

Age: 24 M+

Warning Notice: 12 (page 271)

**56358V90**



ALL COMPONENTS CAN BE ORDERED SEPARATELY.



### Microwave

**56691V90**



### Dishwasher

Dimensions (H x W x D): 40 x 34 x 53 cm

Material: MDF and beech wood, coated

Not included in set

Warning Notice: 12 (page 271)

**56359V90**

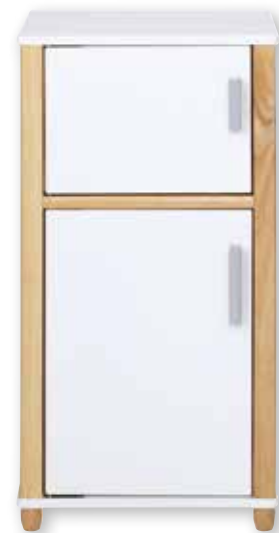

### Refrigerator

Warning Notice: 12 (page 271)

**56690V90**





**Fancy Dresses – Set of 12 pcs. for Toddlers and Babies**

Kings, lions or flowers ... even the littlest ones love to dress up. You can roar like a lion, jump like a rabbit, and so much more! From early childhood on roleplaying increases the social competence and encourages creativity. Having unlimited fantasies is fun and absorbing for children. These comfortable capes and slip-on costumes make dressing up your group very easy – handy Velcro® fasteners enable the children to keep moving around freely. Simply slip into the dress and have fun!

In this set of 12 costumes there is one for everyone in varying sizes and themes: sheep, king, ladybird, flower, crocodile, mushroom, dinosaur, squid, rabbit, leopard, lion and monkey.

Material: 100% polyester, machine washable at 30 °C.

Age: 9 M+ 55988V90 Set of 12 costumes



WITH MANY POCKET ORGANISERS

LARGE STORAGE BASKET



**Mobile Costume Rack**

Ideal storage of dress-up costumes for little kings, fairies and princes ... The pocket organisers at both ends and a convenient wire shelf on the bottom provide plenty of space for stowing small articles. By putting away their costumes themselves, children simultaneously train their motor skills.

The Costume Rack is at children's height. Dimensions (H x W x D): 86 x 96.5 x 45.2 cm

58838V90

 BEST SELLER

### Dressing up Cloaks

Plenty of role plays and performances but only little expenditure of time for creating the costumes ...

No problem with this plentitude of dresses.

Just slip on and (role)play.

Material: 100% polyester, machine washable at 30 °C

All Warning Notice: 1 (page 271)

**52320V90** Set of 13

**54855V90** Set of 4 (lion, tiger, leopard, elephant)

WHAT DO YOU  
WANT TO BE  
TODAY?



### Doll bed

Stable bed of massive beech wood with cover, pillow and mattress. For dolls up to 48 cm. Flatpack, easy to assemble.

Dimensions (H x W x D): 28.5 x 57 x 28 cm

Textile: 100% polyester

Age: 18 M+

Warning Notice: 12 (page 271)

**760491V90**

### Doll cradle

Stable cradle für dolls up to 48 cm. Made of massive beech wood. With bedclothes, mattress and canopy. Canopy, mattress and bedclothes 100% polyester. Flatpack, easy to assemble.

Dimensions (H x W x D): 41.3 x 56 x 37 cm

Textile: 100% polyester

Age: 18 M+

Warning Notice: 12 (page 271)

**760492V90**

### Doll pram

Very stable wooden pram. With blanket and pillow. For dolls up to 48 cm. Cover 100% polyester. Wheels with rubberband, handle 3 times adjustable – usable for children of different ages. Flatpack, easy to assemble.

Dimensions (H x W x D): 50.2 x 52 x 26 cm

Age: 18 M+

Warning Notice: 12 (page 271)

**760495V90**



### Soft Dolls

Lovingly designed dolls. Padded and cosily soft. Different characters available.

Height per doll: app. 30 cm, Material: Textile, machine washable at 30 °C, delicate cycle

**757673V90** Angel

**757674V90** Lara

**757675V90** Silas

**757676V90** Pablo

**757677V90** Paulina

**760322V90** Set of four dolls (without angel)



# FARM ANIMALS

- NATURAL MATERIAL, MADE FROM LATEX THAT IS HARVESTED FROM RUBBER TREES
- VERY SOFT AND FLEXIBLE MATERIAL THAT IS SAFE FOR CHILDREN'S PLAY
- CAN BE USED SAFELY FOR EDUCATIONAL PURPOSES WITH YOUNG CHILDREN (AGE: 12 M+)



**Horse, grey**

Dimensions (H x W x D): 13.7 x 15.5 x 6 cm  
41257V90



**Foal, grey**

Dimensions (H x W x D): 10.9 x 11 x 3.9 cm  
41259V90



**Sheep**

Dimensions (H x W x D): 8.7 x 12.7 x 4.1 cm  
41265V90



**Piglet**

Dimensions (H x W x D): 5.2 x 8.2 x 4.8 cm  
41264V90



**Horse, brown**

Dimensions (H x W x D): 13.5 x 15.5 x 5.3 cm  
41258V90



**Foal, brown**

Dimensions (H x W x D): 10.9 x 11 x 3.9 cm  
41260V90



**Lamb**

Dimensions (H x W x D): 7.5 x 9 x 3.7 cm  
41266V90



**Pig**

Dimensions (H x W x D): 6.3 x 12.3 x 3.8 cm  
41263V90



**Bull**

Dimensions (H x W x D): 10.9 x 17.3 x 5.4 cm  
41267V90



**Cow**

Dimensions (H x W x D): 10.8 x 17.7 x 5 cm  
41261V90



**Calf**

Dimensions (H x W x D): 7.9 x 9.7 x 4 cm  
41262V90

VERY SOFT AND FLEXIBLE



**Farm Animal Set, 11 pieces**

Horse measures: 14 x 16 x 4.5 cm  
Age: 12 M+

97088V90

Minimum order: € 400,-

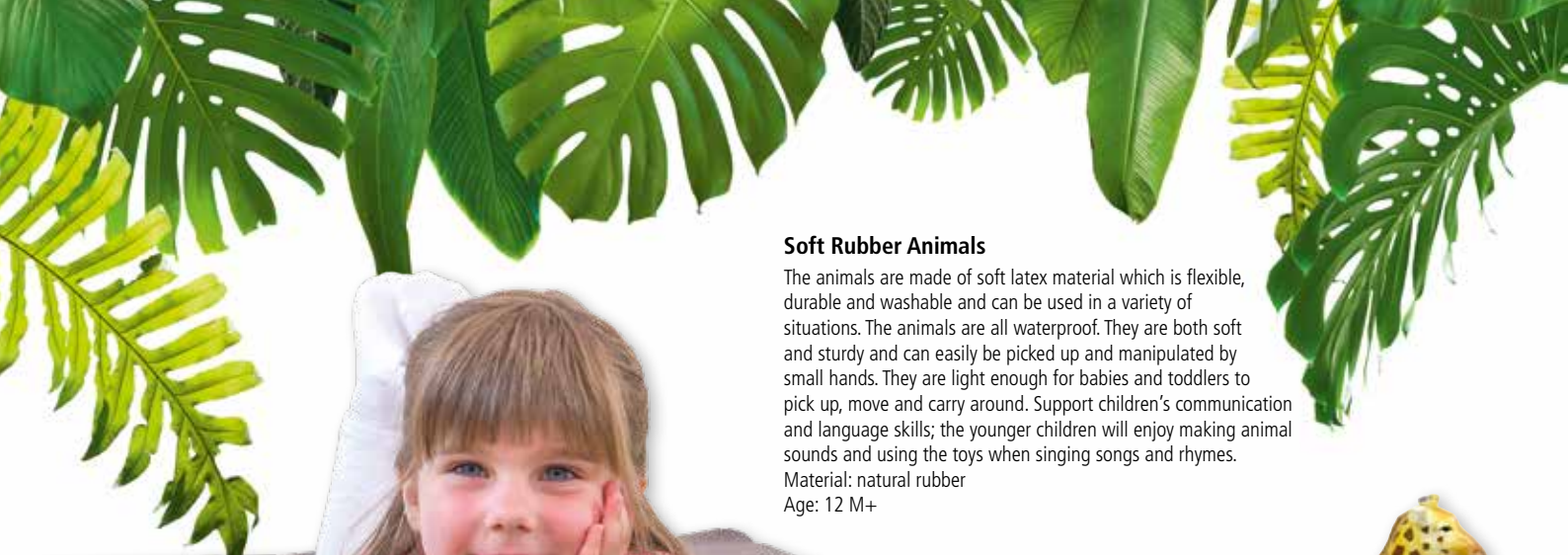

**Soft Rubber Animals**

The animals are made of soft latex material which is flexible, durable and washable and can be used in a variety of situations. The animals are all waterproof. They are both soft and sturdy and can easily be picked up and manipulated by small hands. They are light enough for babies and toddlers to pick up, move and carry around. Support children's communication and language skills; the younger children will enjoy making animal sounds and using the toys when singing songs and rhymes.  
 Material: natural rubber  
 Age: 12 M+



**Giraffe**

Dimensions (H x W x D): 19.3 x 17 x 7.7 cm  
 41272V90



**Asian Elephant**

Dimensions (H x W x D): 12.3 x 18.3 x 8.1 cm  
 41268V90



**Tiger, small**

Dimensions (H x W x D): 7.6 x 16.8 x 6.5 cm  
 41270V90



**Lion, small**

Dimensions (H x W x D): 9.1 x 16.7 x 4.8 cm  
 41273V90



**Rhino, small**

Dimensions (H x W x D): 8 x 16.2 x 5.2 cm  
 41277V90



**African Elephant**

Dimensions (H x W x D): 13.7 x 24 x 8.3 cm  
 41276V90



**Tiger**

Dimensions (H x W x D): 11.5 x 26 x 9.1 cm  
 41271V90



**Lion**

Dimensions (H x W x D): 13.3 x 27 x 8.2 cm  
 41274V90

**JUNGLE ANIMALS**



**Wild Animals, Set of 6**

**Content:** Lion (small), Tiger (small), Asian Elephant, Rhino, Hippo, Giraffe  
 97087V90



**Hippo**

Dimensions (H x W x D): 8.6 x 17.8 x 6.8 cm  
 41275V90



**NEW**

**Carpet "The animals of our world"**

Made from 100% nylon, bottom made from 100% latex  
 With pictures of cities, continents, climate zones and animal's habitats.  
 Size (H x W x D): 300 x 200 x 1.5 cm  
**761207V90**



**Dinosaurs, Set of 5**

**Content:** Hunchback Hunter, Stegosaurus, Brachiosaurus, Tyrannosaurus Rex, Triceratops  
 Age: 24 M+  
**754701V90**



**Stegosaurus, rust**

Dimensions (H x W x D): 15.5 x 29 x 10.5 cm  
 Age: 24 M+  
**41254V90**



**Triceratops, light green**

Dimensions (H x W x D): 10.5 x 26.5 x 6.5 cm  
 Age: 24 M+  
**41253V90**



**Hunchback Hunter**

Dimensions (H x W x D): 20 x 32 x 8.8 cm  
 Age: 24 M+  
**41255V90**



**Brachiosaurus**

Dimensions (H x W x D): 20.5 x 28.4 x 7.5 cm  
 Age: 24 M+  
**41256V90**



**Standing Tyrannosaurus Rex**

Dimensions (H x W x D): 16 x 30 x 11 cm  
 Age: 24 M+  
**41252V90**

Minimum order: € 400,-



**Farm Animals Set 1**

Realistic and durable farm animals in the perfect size for little hands to hold.

**Includes** (1 each): horse, foal, donkey, goat, cow, calf, pig, piglet, sheep, lamb, duck, rooster, hen (2 pcs.)

Size: 5 x 4 cm to 13 x 12 cm

Material: 100% polyvinyl chloride (PVC), washable

Age: 24 M+

**58449V90** 14 pieces

# MOJO FUN

## HIGHLY DETAILED AND HANDPAINTED



**Farm Animals Set 2**

**Content:** Hereford bull, Hereford cow, Hereford calf, border collie, Shetland pony, Shetland foal, pig boar, pig sow, piglet feeding, sheep ram, sheep ewe, lamb laying, cockerel, hen, rabbit

Age: 24 M+

**97819V90** 15 pieces



**Farm Animals Set 3**

**Content:** Holstein cow, Holstein calf, pig, piglet, sheep, lamb, cockerel, hen, donkey, billy goat

Age: 24 M+

**97830V90** 10 pieces



**African Animals**

**Content:** Lion, cheetah, giraffe, rhino, hippo, elephant, cape buffalo, meerkat, zebra, crocodile

Age: 24 M+

**97821V90** 10 pieces



**African Savanna**

**Content:** Lion, lioness, lion cub, cheetah & baby, cheetah, giraffe, giraffe calf, rhino, rhino calf, hippo, hippo calf, elephant, elephant calf, painted dog, meerkat, zebra, zebra foal, crocodile

Age: 24 M+

**97820V90** 18 pieces



**European Woodland**

**Content:** Elk, wolf, fox, rabbit brown, rabbit white, deer stag, deer doe, deer fawn, wild boar, badger, squirrel, lynx, black bear, stoat, hedgehog, snowy owl

Age: 24 M+

**97818V90** 15 pieces





### Arctic/Antarctic Set

**Content:** Snowy owl, ermine, polar bear, polar bear cub, seal, penguin

Age: 24 M+

**97832V90** 6 pieces



### Pets

**Content:** Cat, golden retriever, puppy, border collie, dalmatian, dalmatian puppy, hamster, mouse

Age: 24 M+

**97826V90** 8 pieces



### Ocean Animals

**Content:** Sea lion, orca, penguin, seal, humpback whale, shark, dolphin, clown fish

Age: 24 M+

**97825V90** 8 pieces

# MOJO FUN



### Horse Set

Detailed horses for playing in the farm, the stable or the building corner. **Content:** 4 different horses

Length of horses: grey approx. 13 cm, black approx.

13.5 cm, Andalusian approx. 13.5 cm, foal approx. 10 cm

Material: plastic

**760633V90** 4 pieces



### Dinosaur Set

**Content:** Velociraptor, T-Rex, Triceratops, Stegosaurus, Brachiosaurus, Parasaurolophus, Sarchosuchus, Tylosaurus

Age: 24 M+

**97827V90** 8 pieces



### Woodland Animals

**Content:** Fox, wolf, rabbit, squirrel, stoat, hedgehog, badger, bear, bear cub, deer

Age: 24 M+

**97831V90** 10 pieces



### North American Animals

**Content:** Mountain lion, timber wolf, raccoon, skunk, beaver, snowy owl, bald eagle, pronghorn, grizzly bear, moose, wolverine, buffalo

Age: 24 M+

**97823V90** 12 pieces



### Asian Animals

**Content:** Tiger, tiger cub, komodo dragon, pangolin, proboscis monkey, sun bear, macaque, clouded leopard, panda, panda baby, lemur

Age: 24 M+

**97822V90** 11 pieces



### Dinosaur Deluxe

**Content:** Brachiosaurus, Velociraptor, T-Rex, Triceratops, Stegosaurus, Parasaurolophus, Spinosaurus, Ankylosaurus. Age: 24 M+

**97828V90** 8 pieces



**BEST  
SELLER**



**Sand and Water Table**

Extend your summer activities and take the sandbox inside. This table enables the children to play with water, sand and different toys.  
 Dimensions (H x W x D): 43 x 68 x 68 cm  
 Age: 12 M+

**Content:**  
 1 table, 1 bucket, 6 sand moulds, 1 watering can, 1 ship, 1 shovel-sieve, 2 shovels, 1 rake  
**52300V90**



**Plastic Sand Shovel**  
 Length: 22 cm

- 850157V90 Red
- 850158V90 Blue
- 850159V90 Yellow
- 850160V90 Green
- 850161V90 Pink
- 850162V90 Orange



**Spade**  
 Length: 50 cm

- 850163V90 Red
- 850164V90 Yellow
- 850165V90 Green
- 850166V90 Blue



**Large Garden Bag**  
 Foldable, super lightweight and equipped with sturdy straps.  
 Dimensions (H x W x D): 50 x 60 x 45 cm  
 Material: polyethylene (PE)  
**78508V90**



**Sand Mould Rabbit**  
 Made from durable plastic.  
 Dimensions (H x W x D): 4.5 x 12 x 15 cm, Age: 24 M+  
**759556V90**



**Sand Castle Mold Set**  
 Each piece is made of super strong polypropylene for durability. Comes in assorted colours. Age: 24 M+  
**51263V90**



**Sand and Water Play Bucket**  
 Bucket with pouring spout. Height: 15 cm, diameter: 16 cm. Comes in assorted colours. Age: 24 M+  
**51261V90**



**NEW**

**Horse Game**

The size of the harness is freely adjustable.  
 The snap-closing in the front can easily be opened if "the horse" wants to free itself.  
 100% nylon  
 Not to be used on playground equipment!  
 All Warning Notice: 52 (page 271)

**36219V90** red  
**760448V90** blue



**Walking Rope**

This walking rope makes travelling with a group of children safe and easy. The rope has 7 colourful easy-grasp loops that allow you to safely walk with up to 14 children at once.  
 The loops come in different colours, making assigning each walking rope easy. Includes a Velcro® strap to attach additional ropes to accommodate more children.  
 Warning Notice: 4 (page 271)

**95081V90**



*Fancy Dress*

**Fancy Dress Horse**

Brave knight, proud Native American, beautiful princess or rapid circus rider – slip on the horse and gallop into your imaginary world.  
 Length: 78 cm, height: 58 cm. Machine washable at 30 °C  
 Material: 100% polyester  
 All Warning Notice: 1 (page 271)

**52321V90** Horse Dark Brown  
**52322V90** Horse Light Brown



**Fancy Dress Unicorn**

Material: 100% polyester. Machine washable at 30 °C  
 Warning Notice: 1 (page 271)

**100275V90**



### Discovery Sets – Small Children

All first experiences are sensory. During their early childhood, children obtain a variety of fine motor skills. By trying and repeating, they understand how things work and experience a first feeling of success.

This set stands out through its 'one focus' principle. There is no distraction by colour, imprints, sounds ... By performing one activity, concentration is stimulated and will be more intense.

Children educate themselves. By matching the shapes they see if they make a mistake, understand and are in control of error. This way, first experiences regarding object permanence and form constancy can be achieved. Shape, size, height and quantity are recognised and positioned.

Age: 12 M+

Warning Notice: 35 (page 271)

**56144V90** Set of 12 beech wood puzzles



Tray: 22.5 cm



Tray: 19.5 cm



Tray: 22.2 cm



Tray: Ø 22.3 cm



Tray: 30.3 x 6.8 cm



Tray: 33.5 x 6.8 cm



Tray: 30.3 x 6.8 cm



Tray: 30.3 x 6.8 cm



Tray: 36.7 x 31.5 cm



Height: 23 cm

## SET OF 12 BEECH WOOD PUZZLES



Height: 22.3 cm



Height: 21.8 cm





**Flexible Worm**

Flexible worm with 10 colourful wood parts. Movable thanks to an elastic string. Length: 16 cm  
Age: 18 M+  
**100788V90**

**Attention: Cheese with Holes!**

While playing this fun game, children practise the coordination of hands and eyes and improve their fine motor skills.  
**Content:** 2 balls and playing board 27 x 35 cm  
Material: wood  
Warning Notices: 4, 5 (page 271)  
**50795V90**



**Jigsaw-Threading-Shoes**

Wooden jigsaw puzzle with threading laces.  
Size board: 40 x 21 cm  
3 shoes (Size: ca. 19 x 8 cm)  
3 laces (Length: 130 cm)  
Warning Notices: 4, 5 (page 271)  
**70693V90**



**Lacing Shoe**

Sometimes it is hard for children to practise on their own shoe. This sturdy plastic sneaker is the perfect sized toy for kids to learn how to lace and tie over and over again!  
Dimensions: length: approx. 22 cm, height: 9.5 cm  
Comes with 1 lace, 120 cm  
Warning Notice: 4 (page 271)  
**86226V90**



Minimum order: € 400,-



### Farfallas – Floor Puzzle

125 floor tiles for the development of fantasy, creativity and language skills. Made out of textile with anti-slip underside.

Dimensions: largest tile: 16.2 x 22 cm  
smallest tile: Ø 5 cm

Material: textile

Warning Notice: 2 (page 271)

**760020V90**



### Wooden Blocks

One side of the cube is blank and the other five sides have the same blue pattern. The children can create different shapes and geometrical forms. They discover the features of geometrical figures.

#### Content:

1 wooden tray (21.5 x 21.5 cm)  
16 large wooden cubes (4.5 cm)

**9880V90**

### Pattern Cards

Wooden Blocks

10 plastic cards, printed on both sides (18 x 18 cm)

**9881V90**



### Wooden Threading Shapes

This set consists of colourful threading shapes and laces delivered in a wooden box. Including 7 different shapes and 7 laces (approx. 130 cm each).

Dimensions Box: 16 x 20 x 4.5 cm

Warning Notice: 4 (page 271)

**85494V90** In wooden box with lid



### Big Beads

Threading beads is even more fun with this set of brightly coloured beads in a variety of shapes. Promotes a vast range of skills: fine motor, cognitive & visual perception.

8 laces approx. 90 cm, 80 beads

Age: 18 M+

Warning Notice: 29 (page 271)

**41251V90** 90 pieces in a transparent box



### Small Beads

Children learn to differentiate shapes and colours. The beads can be threaded randomly, encouraging children to improve their eye-hand coordination.

Different shapes approx. 1.7 cm, 8 laces, 90 cm

Age: 3+

Warning Notice: 49 (page 271)

**41341V90** 360 pieces in a transparent box



### Lacing Animals

9 lacing animals (3 bears, 3 ducks and 3 dogs) and laces in 3 different colours.

Great for training colour recognition and sorting skills and for the development of fine motor skills. Can also be used as templates.

Size: up to 15 x 19 cm

Warning Notice: 4 (page 271)

**35681V90**



### Lacing Shapes

81 large plastic shapes (square, triangle and circle) and 27 laces in 3 different colours. Suitable for threading, counting, sorting, classifying and sequencing. Every shape has 4 holes allowing different threading patterns. Size square: 49 cm

Warning Notices: 1, 4 (page 271)

**85052V90** In plastic storage tub



### Giant Lacing Beads

Set of 48 beads in 4 shapes (ball, cube, cylinder, olive) and in 6 colours.

Size of a cube is 4.5 x 4.5 x 4.5 cm

6 laces (65 cm each), in different colours are enclosed.

To develop fine motor skills and logical thinking.

Warning Notice: 4 (page 271)

**900331V90** In plastic storage box



25 PIECES

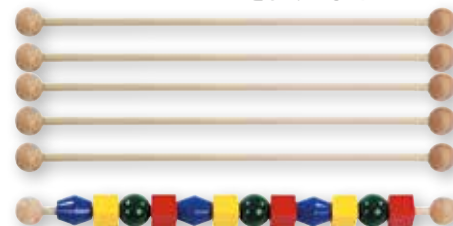

### Giant Beads

Highly polished. 250 giant beads in 6 shapes and in 5 colours. 8 laces enclosed.

Also suitable for small children. To develop sorting, sequencing, counting and visual memory skills. For ages 3 years and up.

Dimensions: up to 2.4 cm

Warning Notice: 49 (page 271)

**761791V90** In plastic storage box

### Threading Skewer

One ball can be removed. Length: 30 cm, Ø 6 mm

Warning Notice: 49 (page 271)

**8766V90** Set of 25 pieces



### Pattern Bead Set

The set contains 120 beads (see 85053V90), 2 wooden stands, 4 laces, 2 mirrors, 24 work cards.

Work cards are printed both sides – recto is colour and verso is black-white. 4 children can play at the same time with the beads provided.

Warning Notices: 1, 4, 5 (page 271)

**86613V90** In plastic storage box

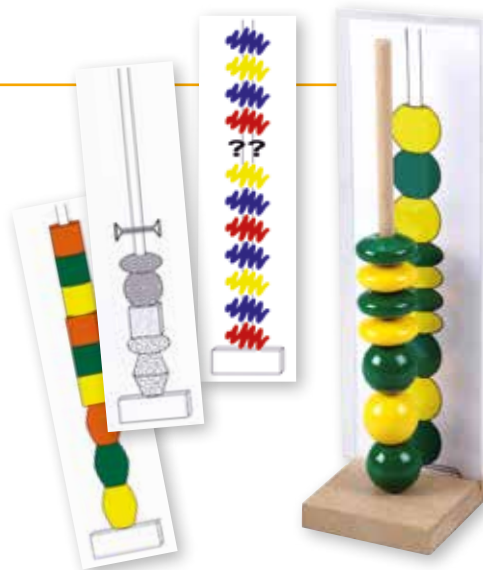

### Work Cards Pattern Beads

Can be bought separately

24 work cards printed both sides

**900335V90**

### Stand for Workcards

**900027V90**



### Thread Beads

900 thread beads made from plastic, washable.

Ø 1.8 cm. Comes with 16 laces.

Warning Notices: 4, 5 (page 271)

**50549V90** In plastic storage box



### Mixed Colourful Set of Beads

650 beads, mixed in colour and form (1.5 cm), and 6 strings

Warning Notices: 1, 4, 5 (page 271)

**50550V90** In plastic storage tub



### Threading Shapes

Enhance eye-hand coordination with this huge set of threading animals. Children learn to focus on the task at hand and will improve their fine motor skills at the same time.

32 lacing shapes, 16 laces, 90 cm

Warning Notice: 49 (page 271)

**41249V90** 48 pieces, in a transparent box



### Tubes Lock Sets

Children create and construct the most amazing cars, tanks, animals, buildings, instruments etc. They have hours and hours of fun.

Great for building up fine motor skills.

All Warning Notice: 1 (page 271)

### Tubes with Wheels

**41308V90** 64 pieces

### Tubes

**41310V90** 80 pieces



ENDLESS  
FUN AND  
POSSIBILITIES



### Fun Building Blocks

Set of 60 pieces in 4 colors: 6 different shapes, 7 figures and 5 wheels

Size of a wheel: 5 cm - thickness 3 cm.

Material: 100% polyethylene

Age: 18 M+

**900330V90** In plastic box



Minimum order: € 400,-



### Medium Grapes

These large brightly coloured plastic grapes can be put together from all directions. 5 colours  
Diameter: 6 cm. Age: 24 M+

**41319V90** 58 pieces per sturdy box

### Snowflakes

Snowflake shaped plastic building blocks – All children aged 3 or up will enjoy the colourful world they can create with this set.

The pieces are durable and safe so they can be used again and again to spark children's imagination.

#### Double-sided snowflakes, small

Diameter: 3.3 cm

Warning Notice: 1 (page 271)

**41318V90** 1000 pieces per sturdy box

#### Double-sided snowflakes, large

Diameter: 5.6 cm

Age: 24 M+

**41317V90** 100 pieces per sturdy box

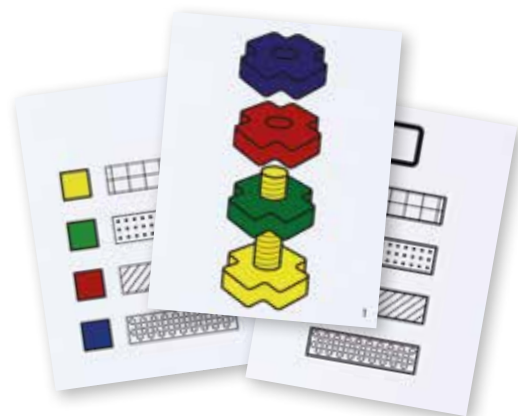

### Work Cards for Pairing Screws

Set of 33 plastic cards (32 exercise cards and one colour code) printed on both sides.

One side for making a pattern, reverse for making a pattern with help of the colour code. Self-correcting.

Dimension: 11 x 8.5 cm

**85586V90** Set of 33



### Screw Game

These self-correcting, oversized, geometrically shaped nuts and bolts give little ones practice in manipulative skills as well as shape and colour matching skills. Made of colourful, durable plastic. Bolts are 6 cm high

Age: 24 M+

**41250V90**



### Groovy Animals

Let your children have fun with this cute and colourful set of assorted rubberised animals, which have been designed with tongue and groove connectors. Great for developing fine motor skills, colour recognition, sorting and creativity. Height: 6.5 cm  
Warning Notice: 1 (page 271)

**41316V90** 72 pieces per sturdy box

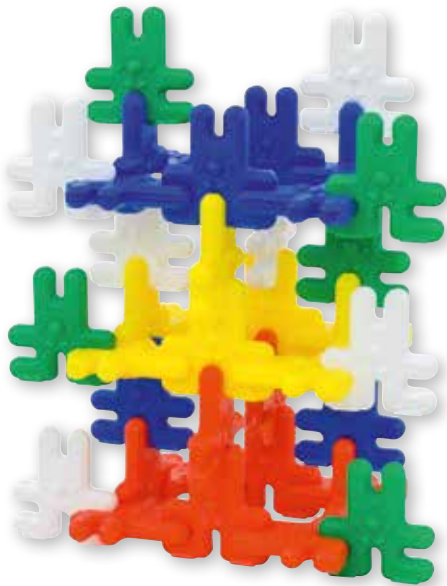

### Construction Rabbits

These funny faced rabbits in 5 bright colours can be slotted together to create amazing constructions. Also young children can start building right away. Set of 50 pieces in a plastic storage box. Size of a rabbit: 8.3 cm  
Material: 100% polyethylene (PE)  
Age: 24 M+

**88406V90** In plastic storage box



### Small Plum Blossoms

Create flowers, trees, animals, space rockets, robots, figurines and other geometric designs. Use the instructions or create with your own imagination! The colourful blossoms help the children build fine motor skills, hand and eye coordination and generate ideas and creativity. Diameter: 4 cm

Warning Notice: 1 (page 271)

**41315V90** 190 pieces per sturdy box



**NEW**



**Building Blocks with Bristles**

136 building blocks with bristles. Made from stable plastic. Suitable for children from 3 years up. Size biggest part (W x H): 11 x 4 cm  
Warning Notice: 1 (page 271)

**759558V90**



**3-D Connect**

Various shapes and sticks can be combined to create 3-D shapes. This colourful set promotes the ability to distinguish different colours and shapes. It also sparks an interest in design and engineering. Dimensions: cube: 3.3 x 3.3 cm  
Warning Notices: 1, 5 (page 271)

**41325V90** 140 pieces in a box

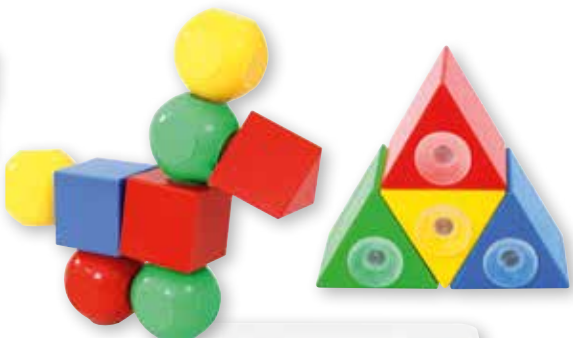

**Suckers**

Quality plastic construction blocks that fit together easily with suction cups for little hands. Dimensions: cube: 5.4 x 5.4 cm  
Age: 18 M+

**41312V90** 42 pieces in a sturdy box



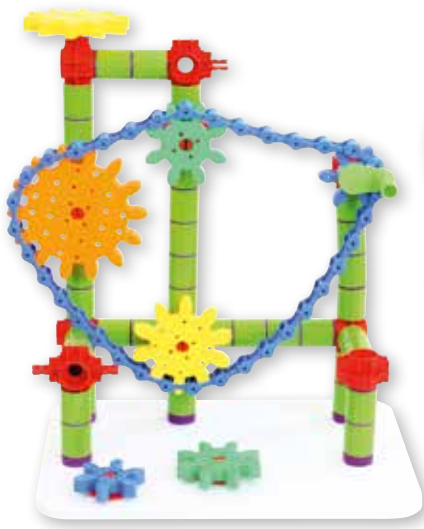

### Gear Set

Interlocking building blocks and gear wheels encourage problem-solving skills and fine motor skills. Playing with this set of building blocks children will be eager to learn more about mechanics and engineering.

Dimensions: large gear: Ø 11.8 cm

Warning Notice: 1 (page 271)

**41301V90** 340 pieces in a box



### Large Constructors

Sturdy bricks for unlimited hours of fun and learning. Building vehicles, shapes or other creative designs is easy and everyone can join in. Students can work together to create something new every day.

Dimensions: wheel: Ø 7.7 cm

Warning Notice: 1 (page 271)

**41306V90** 56 pieces in a sturdy box



### Small Constructors

Improve fine motor skills and dexterity while having fun is possible with this set of constructors. The set contains different shapes and colours which can be combined in many different ways. Challenge your student's thinking and manipulative skills.

Dimensions: wheel: Ø 3.8 cm

Warning Notice: 1 (page 271)

**41305V90** 200 pieces in a transparent box





### Geometric Tangram

Invented in ancient China the puzzle combines learning and fun. Basic geometric shapes help children to classify shapes and to grasp the concept of spatial relationships. Put the pieces together and form given shapes or create your own.

Dimensions: large square: 4.9 x 4.9 cm

Warning Notice: 1 (page 271)

**41320V90** 288 pieces in a sturdy box



### Counting Links

Set with 500 pieces in 4 colours

To develop math skills as sorting, counting, pattern-making, sequencing, symmetry, manipulation, measurement and estimation. For ages 3 years and up.

Dimensions (W x H): 1.7 x 4 cm

Warning Notice: 1 (page 271)

**761790V90** In plastic storage box



### Giant Counting Links

Set with 200 pieces in 4 colours

Easy to manipulate and durable. To promote eye-hand coordination, sorting, counting and colour differentiation. For ages 3 years and up.

Dimensions (W x H): 5 x 7 cm

**85050V90** In plastic storage box

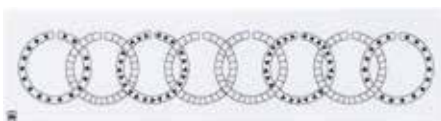

### Geo Links

This set consists of:

**120 links**

3 different shapes (square, triangle and circle) in 4 different colours.

**16 work cards**

(20 x 5 cm) – printed recto-verso

Recto – printed in colour

Verso – printed in black and white with colours represented by symbols (recto is the self-correction of the verso)

**1 card**

indicating which colour is which symbol

Make the patterns of the links shown on the workcards. There are 4 different series of work cards – each with its own symbol. If you use them together, you will always have enough links! Children should start with the coloured side. Afterwards they can continue with the more difficult side. Ideal material to develop fine motor skills and think logically.

Warning Notice: 1 (page 271)

**900378V90** In plastic storage box





**Smart Pieces**

Tiles in different shapes are assembled with black connectors. An endless amount of structures and shapes can be created. This large set of tiles teaches patterning, shape & colour recognition, building and motor skills. Inspire your student's imagination and spark their interest for science, engineering and design.  
 Dimensions: square: 6.4 x 6.4 cm  
 Warning Notice: 1 (page 271)  
**41311V90** 300 pieces in a sturdy box

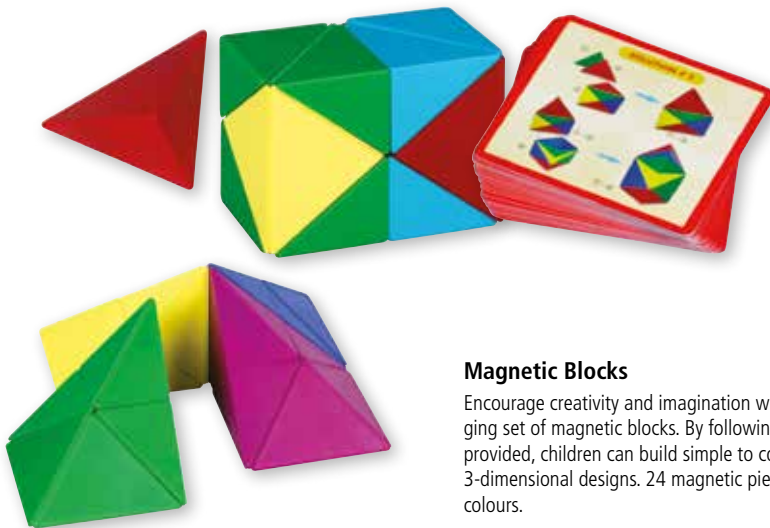

**Magnetic Blocks**

Encourage creativity and imagination with this challenging set of magnetic blocks. By following the designs provided, children can build simple to complex 3-dimensional designs. 24 magnetic pieces in four colours.  
**91776V90**



**Simple Puzzle**

100 pieces  
 Warning Notice: 1 (page 271)  
**41321V90**



**Tricky Fingers**

A tricky game for fingers and brain! Moving the 16 balls to get the pattern of the instruction card is fun and develops both dexterity and concentration.  
**Content:**  
 2 black game boxes, 16 balls, 14 instruction cards.  
 Warning Notices: 1, 5 (page 271)  
**85576V90**



**Triangle Puzzle**

This pyramid can be pulled apart into 4 progressively smaller pyramids and then into 15 separate shapes (from 2 x 2 cm up to 12 x 12 cm). Many different shapes can be formed by using multiple triangle puzzles – possibilities are endless. Balance, stack and build with 3-dimensional pieces.  
 Different examples enclosed.  
 Warning Notice: 1 (page 271)  
**85056V90**



# MAGNETIC TILES FOR INFINITE CREATIONS

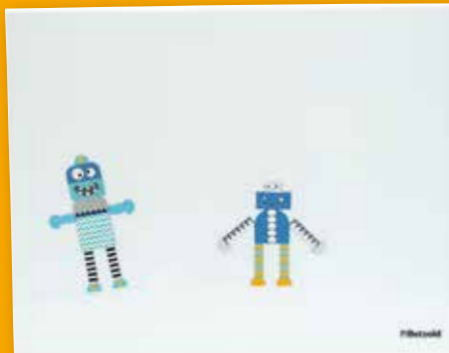

## Mix and Match

### Magnetic Puzzle Games

Combine the magnetic tiles to beautiful butterflies, funny creatures or colourful patterns  
All Warning Notice: 1 (page 271)

**757410V90** Mix & Match Farfallas, 174 pieces plus two mini whiteboards

**757856V90** Mix & Match Mini Bots and Friends plus two mini whiteboards

**757687V90** Mix & Match Mosaico



**MAGNETIC**

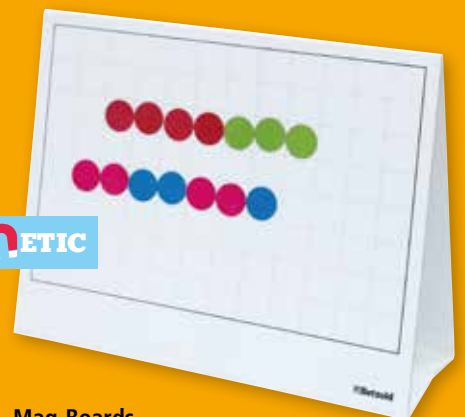

## Mag-Boards

Large magnetic activity stands. Both sides are magnetic. The boards are portable and foldable for easy storage. Dimensions (W x H): 46 x 37.5 cm

**757052V90** Mag-Board with lines, backside blank

**757050V90** Mag-Board with grid, backside blank



### 100 Mosaics

(3.5 mm thick)

Warning Notice: 1 (page 271)

95150V90

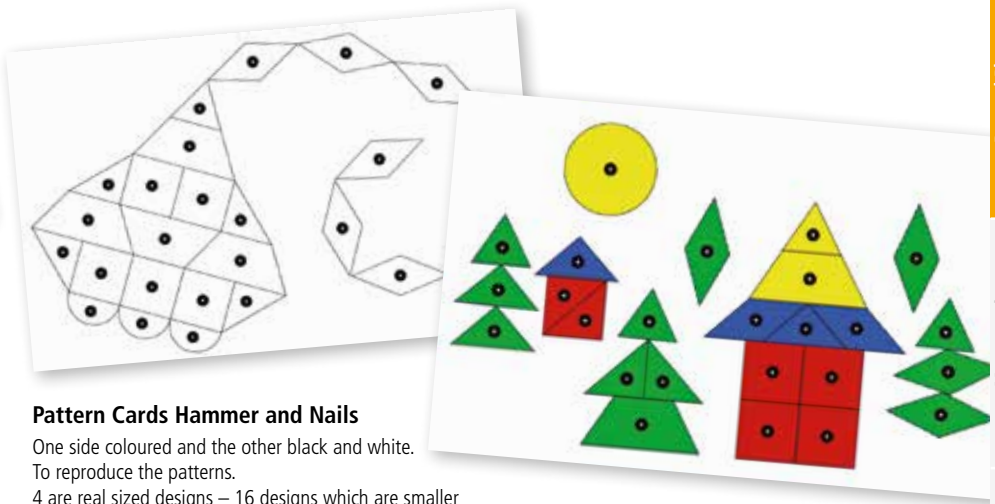

### Pattern Cards Hammer and Nails

One side coloured and the other black and white.

To reproduce the patterns.

4 are real sized designs – 16 designs which are smaller and more difficult to reproduce.

2 cards (24.5 x 15.5 cm)

8 cards (12.5 x 7.5 cm)

86614V90



### Hammer

(Length: 19 cm)

Warning Notice: 10 (page 271)

35826V90



### Cork Board

Dimensions (H x W x D): 15 x 25 x 1 cm

35827V90



### Plastic Box with ca. 250 Nails

Warning Notices: 10, 43 (page 271)

35828V90

## CREATE BRIGHTLY COLOURED DESIGNS!



**BEST  
SELLER**

### Tap a Shape – Hammer and Nails

A well loved activity which allows children to develop eye-hand coordination. This set offers quantity and quality. Small handworkers create their own designs or reproduce the patterns provided.

#### Content:

- › 200 mosaics in 9 shapes and 4 colours – beech wood 3 mm thick
- › 4 wooden hammers, size 19 cm
- › 4 cork boards, size: 250 x 155 x 10 mm
- › 1 plastic box with ca. 250 nails
- › 4 pattern cards

Warning Notices: 1, 10, 43 (page 271)

35824V90 Complete set



Minimum order: € 400,-



### Sorting & Counting Pebbles

6 colours available  
 Children will be fascinated by these brightly coloured pebbles which are also smooth to the touch. The pebbles will inspire various mathematical activities: sorting, counting, patterning or sequencing.  
 Bag with 250 pieces  
 All Warning Notice: 1 (page 271)

- 850092V90** blue
- 850093V90** green
- 850094V90** red
- 850095V90** orange
- 850096V90** pink
- 850097V90** yellow
- 850287V90** purple
- 940V90** Set: all 7 colours



### Foam Blocks

Geometric forms. Create your own buildings.  
 Comes in a plastic storage bag.  
 All Warning Notice: 1 (page 271)

- 900341V90** Set of 52
- 57939V90** Set of 68

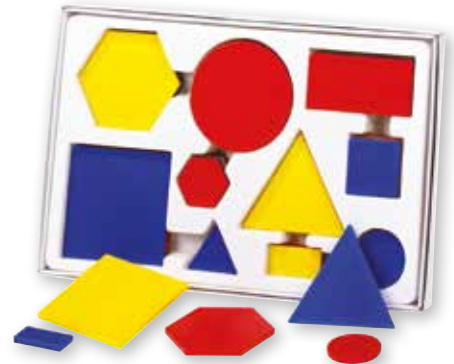

### Attribute Blocks

Ideal material to develop sorting and classification skills.  
 Provides an introduction to logic activities.  
 (Dimensions: large square: 7.5 x 7.5 cm)

**Content:**  
 60 pcs. – 5 shapes (circle, square, hexagon, rectangle, triangle) in 3 colours (blue, red, yellow), 2 sizes and 2 different thicknesses.

Warning Notice: 1 (page 271)

**50599V90**

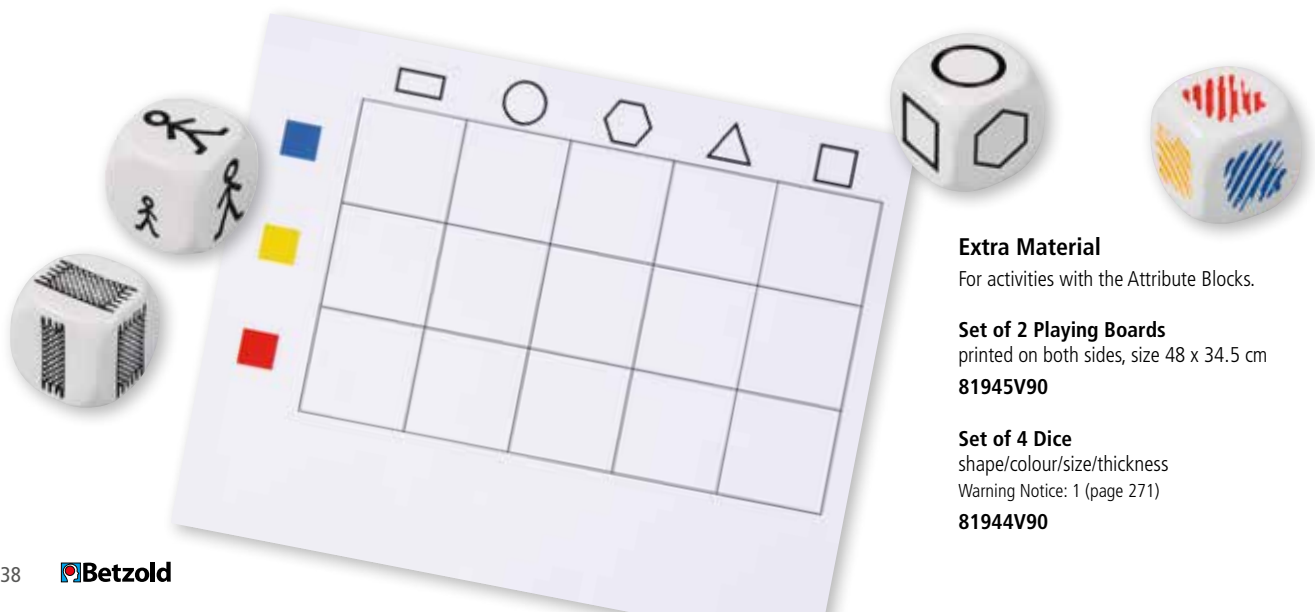

### Extra Material

For activities with the Attribute Blocks.

**Set of 2 Playing Boards**  
 printed on both sides, size 48 x 34.5 cm  
**81945V90**

**Set of 4 Dice**  
 shape/colour/size/thickness  
 Warning Notice: 1 (page 271)  
**81944V90**



### Square Mosaic

Lay patterns and ornaments, make reflections of geometrical shapes or create pictures. 350 squares in 12 colours animate the user to work again and again with mosaic.

Set 1: 350 plastic squares (2.3 x 2.3 cm) in 12 colours  
Warning Notice: 1 (page 271)

**81959V90** 1 plastic patch panel

### Pattern Cards Square Mosaic

There are 3 kinds of exercises:

- 4 exercises with the mirror
- 4 exercises to be reproduced
- 4 exercises to be completed

**Content:** 6 cards – printed on both sides (16 x 16 cm)

**87240V90**

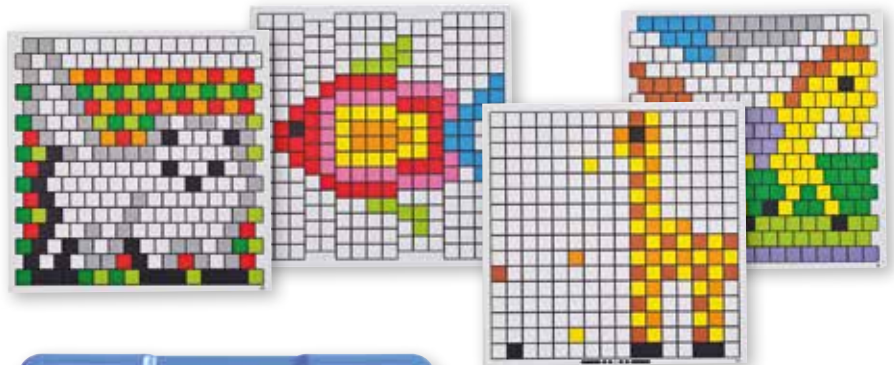

### Large Mosaic

This large grid mosaic puzzle board will help the children to develop their creativity while offering hours and hours of fun. They can use their own imagination or the sample images included with the game.

Exciting and educational, this game is a neat occupation for any child from the age of 3.

Dimensions (H x W x D): 7 x 25 x 25 cm

Warning Notice: 1 (page 271)

**41303V90** 100 pieces per sturdy box



### Colourful Wooden Cubes

To build towers or other constructions.

Stimulates spatial awareness.

100 wooden cubes 2 cm in 6 different colours.

Warning Notice: 1 (page 271)

**85188V90** In storage box

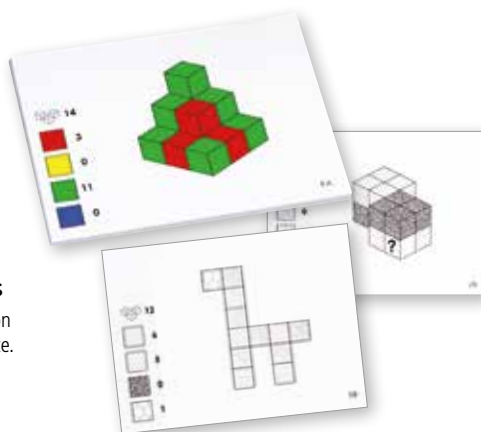

### Work Cards for Colourful Wooden Cubes

Set of 16 cards – dimension 16 x 12 cm – printed on both sides. Recto – colour and verso black and white.

The black and white side works with a colour code.

**81941V90**

Minimum order: € 400,-

**NEW**



### Translucent Plug-in Building Blocks

Made from durable plastic. Compatible with conventional plastic building blocks. Suitable for light tables.

Size biggest part (H x W x D): 1.2 x 1.6 x 3.2 cm

Warning Notice: 1 (page 271)

**759557V90** 1000 pieces in stacking box



### Translucent Pattern Blocks

6 shapes and 6 colours, for using in pattern and sequencing activities, for counting and sorting, or for colour and shape recognition

Box size (H x W x D): 17 x 17 x 30 cm

Warning Notice: 1 (page 271)

**759541V90** 360 pieces in stacking box



### Translucent Counters, pluggable

6 different colours. Can be used for counting, sorting, pattern-making and sequencing.

Box size (H x W x D): 17 x 17 x 30 cm

Warning Notice: 1 (page 271)

**759543V90** 1000 pieces in stacking box



### Translucent Octagonal Discs

Encourages to construct abstract or symmetrical structures and to develop fine motor skills. 6 different colours.

Box size (H x W x D): 17 x 17 x 30 cm

Warning Notice: 1 (page 271)

**759539V90** 900 pieces in stacking box



### Colour Cubes

Create buildings and patterns with these brightly coloured translucent cubes. Introduce children into the creative world of building and cultivate their phantasy and perceptual skills. Children learn and improve sequencing, patterning, fine motor skills and mathematical skills.

Each set consists of 36 blocks (9 green, 9 yellow, 9 red and 9 blue) and is packed in a storage container.

Dimensions: 4 x 4 cm. Age: 24 M+

**41313V90** 36 pieces in a storage container



### Round Light Table

- › Extremely light and stable
- › The higher edge prevents sand, grains and other fine materials used to create images etc. from falling out.
- › Remote control with light change function is included. Multiple children can play at the same time.

Can be used as a nightlight

Dimensions: diameter: 50 cm, height: 12.5 cm

Warning Notice: 2 (page 271)

**760424V90**



### Farm Animals

72 pieces and 6 species. Size of a hen: 3.3 cm, in bucket  
Warning Notice: 1 (page 271)

87258V90



### Water Animals

84 pieces and 14 species. Size of a whale: 5.8 cm, in bucket

Warning Notice: 1 (page 271)

87263V90

### Vegetables

144 pieces in bucket. Size of a carrot: 6 cm  
Warning Notice: 1 (page 271)

87257V90



## COUNT, SORT & CLASSIFY

### Fruit

108 pieces in bucket. Size of a banana: 5 cm  
Warning Notices: 1, 5 (page 271)

86668V90



### Vehicles

72 pieces in bucket. 6 shapes (plane, boat, train, car, bus, helicopter) in 6 colours. Size of a train: 4 cm

Warning Notice: 1 (page 271)

900379V90 In plastic storage tub



### Large tweezers, set of 6

Ideal size for children to manipulate. Use for picking up small counters in sorting or patterning activities, to improve finger and hand strength and to develop coordination skills.

759551V90



## CONVINCING FEATURES OF BETZOLD SNAP-X

- > MADE IN GERMANY
- > WONDERFUL, SIMPLE CLICK SYSTEM
- > SUITABLE FOR INDOORS AND OUTDOORS
- > ROBUST AND DURABLE
- > SUPPORTS PHANTASY, CREATIVITY AND ESPECIALLY MOTOR SKILLS
- > USE THE PARTS TO ENLARGE AND CONVERT BUILDINGS
- > YOU CAN PLUG THE PARTS TOGETHER AND PULL THEM APART AGAIN WITHOUT MUCH EFFORT
- > MOTIVATING GAME WITH PROMPT SUCCESS



## VERSATILE, INTELLIGENT AND 100% MADE IN GERMANY

The Betzold SNAP-X construction games are amazingly versatile. Due to their simple click system, the kids will have a feeling of success in almost no time! The intelligent construction game with solid, durable parts will create a lot of fun and furthermore train motor skills and fantasy in a playful way. You can click together and enlarge all parts versatily due to the connectors. The colourful parts motivate every child to create new, imaginative buildings again and again!

## CREATE AN OWN ADVENTURE WORLD

No matter, if a knight's or a princess's castle, a church, a mall or an own house – there are no limits to the imagination of girls and boys with Betzold SNAP-X! In connection with their favourite toy figures, cars and other dolls they create their own world day after day within inspiring role plays.

## AMAZING CONSTRUCTIONS CLICK BY CLICK

You are able to build three-dimensional structures, giant constructions and also a variety of geometrical figures. Panels and connectors are put together, similar to the modern panel construction. This simple click system and the bright colours of the parts enable to create any building in no time. Furthermore the multifaceted construction toys are very interesting for your institution.



### SNAP-X

#### Starter Pack, 100 parts

The starter set for impressing results and a great gaming experience. Build castles, houses, towers, stables, garages and fantastic structures.

Warning Notice: 1 (page 271)

**758837V90** 100 parts

### SNAP-X

#### Basic Package, 300 parts

The Betzold SNAP-X basic package enables you to create a limitless number of different constructions and buildings. Lots of different parts, connectors and building modules enable great 3D construction fun for a group of children.

Warning Notice: 1 (page 271)

**758155V90** 300 parts

### SNAP-X

#### Starter Pack, 500 parts

The big Betzold SNAP-X starter set with 500 colourful parts offers an amazing construction fun. Hundreds of bricks, connectors, grids and frames ensure a totally new experience of 3D construction for a whole group. Includes flames for imaginative play and triangles for special constructions like boats.

Warning Notice: 1 (page 271)

**758502V90** 500 parts

### SNAP-X

#### Giant Set, 700 parts

The Betzold SNAP-X giant set is the perfect construction game for creating big buildings, towers, exciting castles and fantastic palaces. The big amount of pieces is ideal for groups and classes. Includes tracks and special connectors for ball paths and ramps.

Warning Notice: 1 (page 271)

**758430V90** 700 parts

# JOURNEY TO DISTANT GALAXIES



SPACESHIP

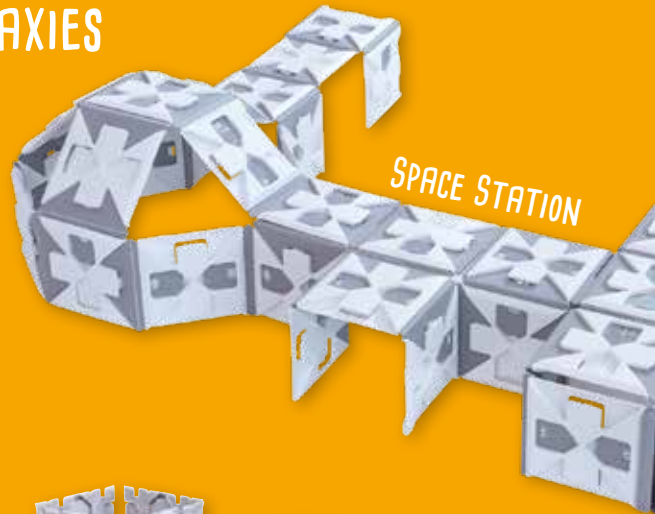

SPACE STATION



## SNAP-X

ONE SET -  
1000 POSSIBILITIES

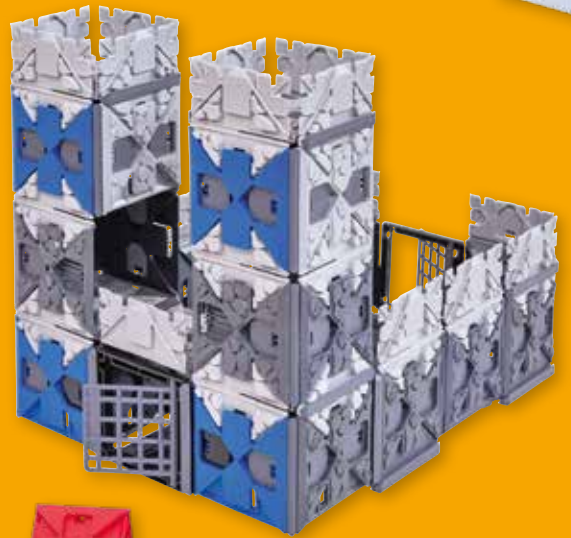

WATCHTOWERS



### SNAP-X

#### Large Space Set

Construction set for a space station, a spaceship or a rocket. With components in stone look and with flame elements. Simple click system made in Germany. Suitable for indoor and outdoor use.

**Content:** 210 parts, manual

Warning Notice: 1 (page 271)

**760103V90**

### SNAP-X

#### Knight's Castle Set

Theme set with many SNAP-X components for a large knight's castle. With parts in excellent stone and wood optics, as well as flame elements. Simple click system made in Germany. Suitable for indoor and outdoor use. Delivery without decoration/toy figures.

**Content:** 436 parts, manual

Warning Notice: 1 (page 271)

**758503V90**

### SNAP-X

#### Tracks and Ramps

Construction set for ball tracks or race tracks for toy cars. Simple click system made in Germany. Suitable for indoor and outdoor use.

**Content:** 120 parts, manual

Warning Notice: 1 (page 271)

**758504V90**

### SNAP-X

#### Farm Horse Stable

Theme set with many SNAP-X components for a stable, a farm or a riding hall with run and hurdles. With parts in excellent stone and wood optics as well as grids. Simple click system made in Germany. Suitable for indoor and outdoor use. Delivery without decoration/toy figures.

**Content:** 176 parts, manual

Warning Notice: 1 (page 271)

**758600V90**



HORSE STABLE WITH  
LARGE GATES



# SNAP-X

## FARM & HORSE STABLE



ENOUGH SPACE IN THE  
BOX FOR MARE AND FOALS

### SNAP-X

**Components Stone Look**

Warning Notice: 1 (page 271)  
759001V90 110 parts

### SNAP-X

**Connector Flex**

Warning Notice: 1 (page 271)  
759002V90 60 parts

### SNAP-X

**Flames**

Warning Notice: 1 (page 271)  
758980V90 30 parts

### SNAP-X

**Components Wood Look**

Warning Notice: 1 (page 271)  
758987V90 90 parts



Minimum order: € 400,-

# MONTESSORI



## Tower

This set contains ten wooden cubes graded in size from  $1 \text{ cm}^3$  to  $10 \text{ cm}^3$ .

These cubes develop visual distinction of size in three dimensions.

Working with this material prepares the child to understand mathematical concepts in the decimal system, geometry, and volume.

Made of rubber wood.

All Warning Notice: 1 (page 271)

**50508V90** Pink tower

**50133V90** Natural colour tower



## Brown Stair

These are ten hardwood cuboids that are painted in brown lacquer. They are graded in width while the length remains constant. These cubes develop visual and muscle perception of dimension. The child will be able to understand different mathematical concepts by using this material. Dimensions: Largest block:  $10 \times 20 \times 10 \text{ cm}$

Made of rubber wood.

**50485V90**

## Mystery Bags – Geometric Shapes

A set of two cloth bags, each containing a set of small geometric solids for matching.

**Content:** 10 pairs of geometric solids

Size of bag:  $25 \times 17.5 \text{ cm}$

Size of cube:  $2.5 \text{ cm}$

Warning Notices: 1, 5 (page 271)

**85761V90**

## Geometric Solids

The geometric solids prepare a child for geometry, allows the child to compare different three-dimensional shapes, and improve concentration, coordination, independence, and problem solving skills.

The set contains a cylinder, cube, ellipsoid, cone, sphere, square-based pyramid, triangular-based pyramid, ovoid, rectangular prism and triangular prism finished in blue colour.

Height: 10 cm

Warning Notice: 7 (page 271)

85162V90



## Flat Geometric Figures with Box

The flat geometric figures allow a child to explore the geometric solids further, and learn their bases.

A box containing 12 pieces of wooden flat figures and three stands for geometric solids.

Warning Notice: 7 (page 271)

85163V90

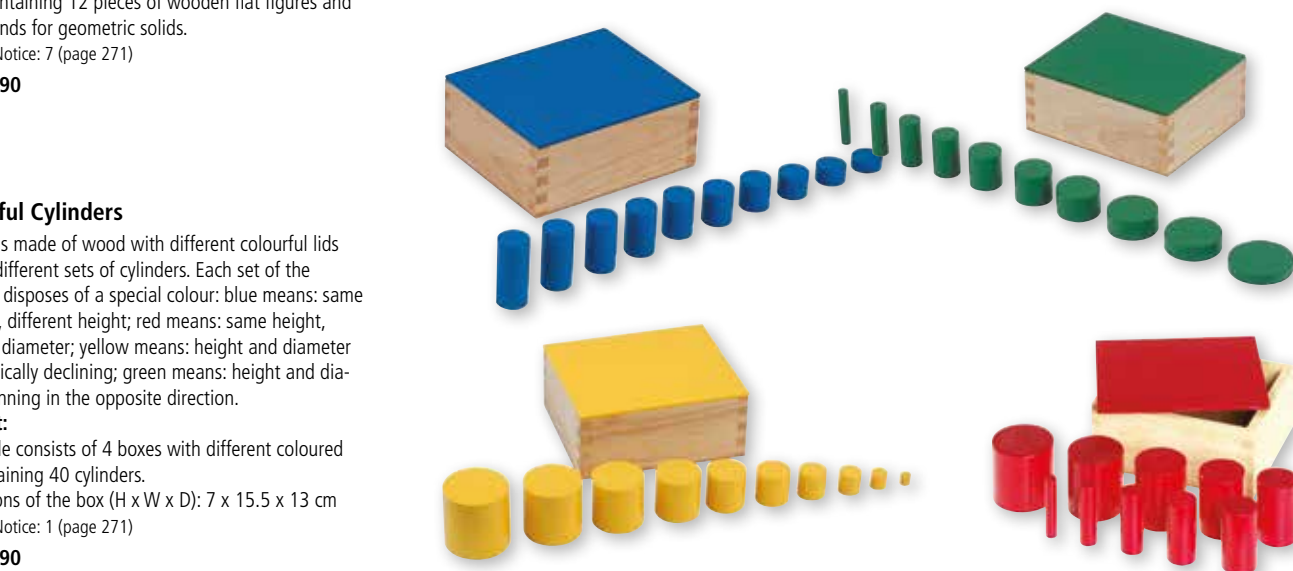

## Colourful Cylinders

The boxes made of wood with different colourful lids contain different sets of cylinders. Each set of the cylinders disposes of a special colour: blue means: same diameter, different height; red means: same height, different diameter; yellow means: height and diameter synchronically declining; green means: height and diameter running in the opposite direction.

### Content:

The article consists of 4 boxes with different coloured lids containing 40 cylinders.

Dimensions of the box (H x W x D): 7 x 15.5 x 13 cm

Warning Notice: 1 (page 271)

85263V90

TEACHES VISUAL  
DISTINCTION  
OF DIMENSIONS

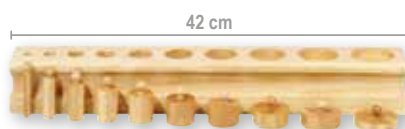

height decreases, diameter decreases



height and diameter increases



diameter increases, height remains constant



diameter remains constant, height increases

## Knobbed Cylinder Blocks (Set of 4)

This is a set of four wooden, lacquered cylinder blocks. Each block contains ten knobbed cylinders of varying dimensions.

The cylinder blocks help develop the concept of visual distinction of size.

Length of each block: 42 cm

Warning Notice: 1 (page 271)

85669V90

Minimum order: € 400,-



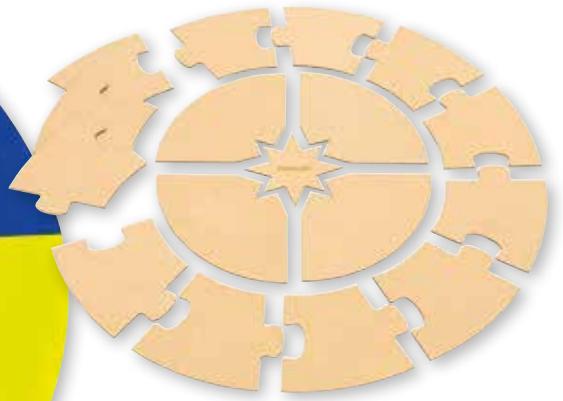

**Annual Circle to Design Yourself**

17-part annual circle according to Montessori methods made of MDF

The quadrants around the sun represent the seasons. In the Montessori annual circle the assignment of colours is set as follows: winter (blue), spring (green), summer (yellow), autumn (red).

The 12 outer circle segments represent the months. We recommend to paint the MDF boards with acrylic.

**70812V90**



**Globe**

Montessori geography material-globe of world parts.

Comes with a wood stand.

Size: Globe diameter: 18 cm, Material: wood and metal

**85774V90** Coloured Continents

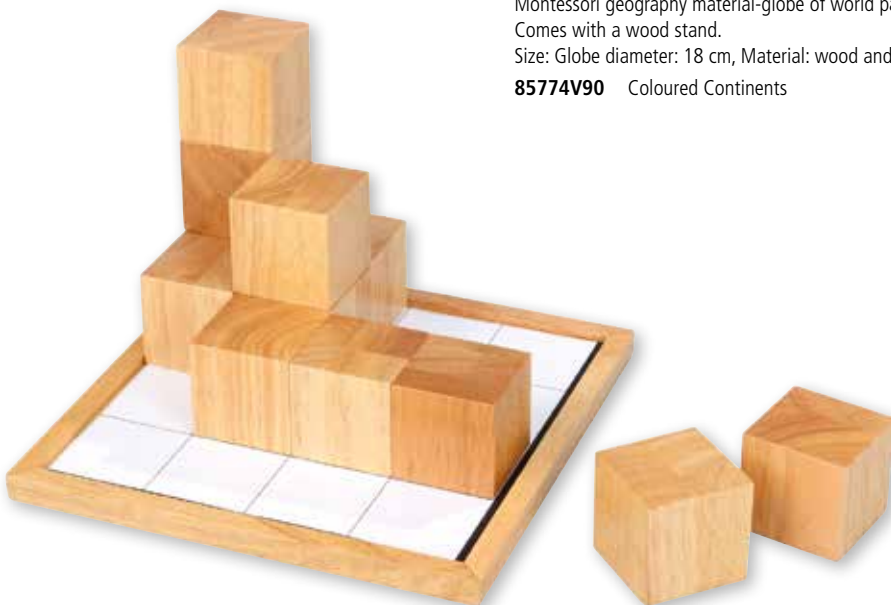

**Plain Wooden Cubes**

Dimensions box: 20 x 20 x 5 cm

Cube: 4.5 x 4.5 x 4.5 cm

**87335V90**





### Colour Tablets

The direct aim of this product is the development of the chromatic sense.

Children learn to differentiate between various colour shades with exercises based on organising and sorting the tablets (for example from "lighter" to "darker"). Wooden box contains: 63 tablets, divided into nine compartments, each containing seven gradations of pink, yellow, blue, green, orange, brown, red, purple and black

Dimensions tablets (W x H): 6.3 x 3.2 cm

Dimensions box (W x H): 32.5 x 32.5 cm

Material: plastic

**85788V90**



### Sound Boxes

This set of 6 pairs of sealed wooden cylinders in two matching boxes refines a child's auditory sense and memory, and aids the vital skill of listening concentration. Each pair of cylinders (one red and one blue) makes a different sound in a range from loud to quiet when shaken. The child has to find the matching pairs by carefully listening to the different sounds made. They can help to identify a child with hearing difficulties. A set of cylinders can also be graded from loud to quiet.

#### Content:

12 cylinders, 8.5 cm high, 2 wooden boxes (11 x 10 x 8 cm)

Warning Notice: 1 (page 271)

**50131V90**



### Tasting Bottles

This set of 4 pairs of bottles with dropper lids on a wooden stand refines a child's gustatory sense. Each pair of bottles (one with a white top and one with a black top) can be filled with the basic tastes of sweet, sour, salt and bitter. The child has to find the matching pairs by carefully tasting the different contents.

#### Content:

8 bottle s à 20 ml, 1 wooden tablett, 20 x 10 cm

**85760V90**



### Coloured Pencil Holders

11 pencil holders in 11 colours: red, blue, yellow, green, brown, black, white, pink, purple, orange and grey.

Dimensions: diameter: 4.5 cm, height: 6.5 cm

Delivery without pencils.

**51577V90**



### Blindfolds

Funny blindfolds for children.  
Material: 100% polyester

#### Blindfold Professor

Dimensions (W x H): 16 x 7.5 cm

**755867V90**

#### Blindfold Clever Fox

Dimensions (W x H): 16 x 8 cm

**755875V90**





**BEST  
SELLER**

### Dressing Frames

Montessori dressing frames are designed to help children practise fastening various clothing fasteners so that they can dress themselves. The frames are made of wood and have fabric stretched around them. The fabric fastens in the front of the frame with a given fastener.

Dimensions (W x H): 37 x 41 cm

Warning Notices: 1, 4 (page 271)

**50635V90**

### Dressing Frame Holder

Wooden stand that holds up to 6 dressing frames

Dimensions (H x W x D): 47.5 x 39.5 x 20.5 cm

**50636V90**



### Car Parade

3 types of closing mechanisms:

- › push button
- › stud
- › Velcro® closure

**Content:** 10 parts, length assembled: ca. 2 m

Warning Notice: 1 (page 271)

**757047V90**



**NEW**



**NEW**

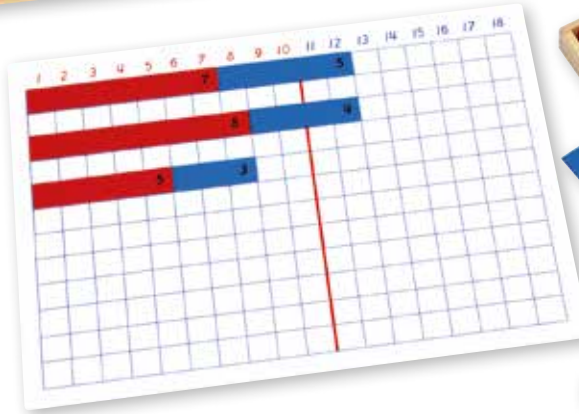

**NEW**

### Small Number Rods

Two sets of ten small wooden rods divided into units by alternating colours of red and blue. The rods are constant in height and width (1 cm) while graduated in length from 2.5 cm to 25 cm. The rods are presented in a wooden box that includes one set of wooden number tiles 1-10.

Dimensions box (H x W x D): 3 x 34 x 14.5 cm

Warning Notice: 1 (page 271)

**89396V90**

### Addition Strip Board

The students practice addition exercises in number range up to 18, with the transition from tens to numbers being illustrated particularly clearly.

The geometric representation of the arithmetic problem makes it easier to solve the tasks.

#### Content:

1 calculating board (58 x 42 cm)

9 pieces red stripes: number 1 to 9

9 pieces blue stripes: number 1 to 9

Warning Notice: 1 (page 271)

**86541V90**

### Subtraction Strip Board

The striped board for subtraction offers a vivid way to practice the basic tasks in number range up to 18. In particular, the transition from one to the next is trained.

#### Content:

1 calculating board (48.3 x 35 cm)

9 pieces red stripes: number 1 to 9

9 pieces blue stripes: number 1 to 9

Warning Notice: 1 (page 271)

**86542V90**



### Spindle Box

This single tray spindle box comes with 45 spindles in a box. An excellent material used to help the child understand how numbers can be represented as separate objects. It also helps the child understand the meaning of 'zero'.

Dimensions (H x W x D): 7 x 52 x 22 cm

**50624V90**

### Red and Blue Rods

Ten rods, which vary in length from 10 cm to 1 metre by 10 cm increments. The rods are coloured blue and red, alternation of colour occurring every 10 cm.

Dimensions: 10–100 cm

**89393V90**



### Wooden Number Tablets

Showing the numbers from 1 to 10.

Dimensions (W x H): 10 x 7 cm

Made of lacquered wood

**86744V90**



**Plastic Number Cards with Box**

Wooden tray with laminated cards for the place values of 1, 10, 100 and 1000. Cards differ in length depending on their number value. Children learn to construct 4-digit numbers and understand the decimal system with ease.  
**85792V90**



**Felt Mat**

As they place the beads along the mat, children can separate, count, compare and bring beads into ranking order. Dimensions (W x H): 100 x 21,5 cm  
 Material: 100% polyester felt  
**85782V90**



**Multiple Bead Chains**

Box with compartments and lid. 60 of each coloured bead chain, 1 thru 9 and 110 bead chains of 10. Children are able to explore and visualise the multiplication tables.  
**85786V90**



**Individual Beads for Decimal System**

Wooden box with four compartments to hold a bead cube of 1000, nine bead squares of 100, nine bead bars of 10 and nine golden bead units in a wooden tray with dimples. This bead material offers an introduction to the decimal hierarchy. Children can practice the formation and place value from one to thousand.  
 Warning Notice: 42 (page 271)  
**85769V90**



**Coloured Bead Stair**

Children place the segments in numeral order and learn to associate the quantities 1 through 9. For simple addition and subtraction activities. The bead stair consists of 9 segments of wire strung with one to nine beads as well as 9 bead bars of 10 and comes in a compartmentalised wooden box.  
**85787V90**

# MONTESSORI MATERIAL

## Pythagoras Board

Wooden frame, Dimensions (W x H): 34 x 34 cm  
Framed wooden board with one hundred squares labeled 1–10 across and 1–10 down, and a wooden box containing printed wooden answer chips.

The child chooses a wooden answer chip, thinks of a multiplication equation that produces this product, and then places the chip in the correct position on the ruled board. This activity is used to reinforce concept of multiplication.

**85779V90** Pythagoras Board

Warning Notice: 1 (page 271)

**85780V90** Pythagoras Board Control Chart



## Hundred Board

Wooden frame, Dimensions (W x H): 34 x 34 cm  
Framed wooden board with 100 squares and a wooden box containing small wooden tiles labeled 1 to 100. The wooden chips are to be placed in sequence on the board.

The control chart allows for independent work and immediate corrections using the hundred board.

**85777V90** Hundred Board

Warning Notice: 1 (page 271)

**85778V90** Hundred Board Control Chart



## Multiplication Board

Dimensions (W x H): 25 x 25 cm

The multiplication bead board is used for practice with the multiplication tables 1 x 1 through 10 x 10. The box consists of the multiplication working board, a box with small plastic cards numbering 1–10, which represent the multiplicand, a red disc which marks the multiplier and a box of 100 red acrylic beads.

Warning Notice: 5 (page 271)

**85784V90**

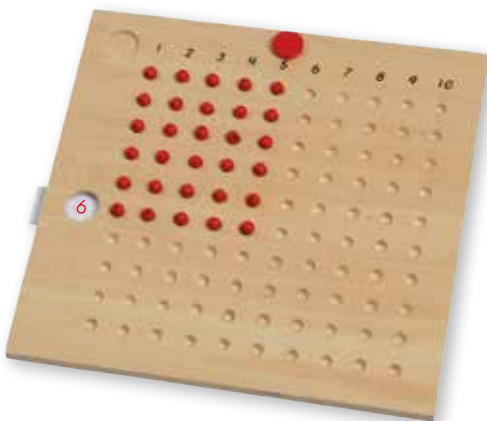

## Division Board

Dimensions (W x H): 25 x 25 cm

The division board helps the child to learn and practice the table of division with dividends 1–81 and divisors 1–9. This set includes a wooden division board and a box containing 9 checker pins and 100 green beads.

Warning Notices: 1, 5 (page 271)

**85785V90**

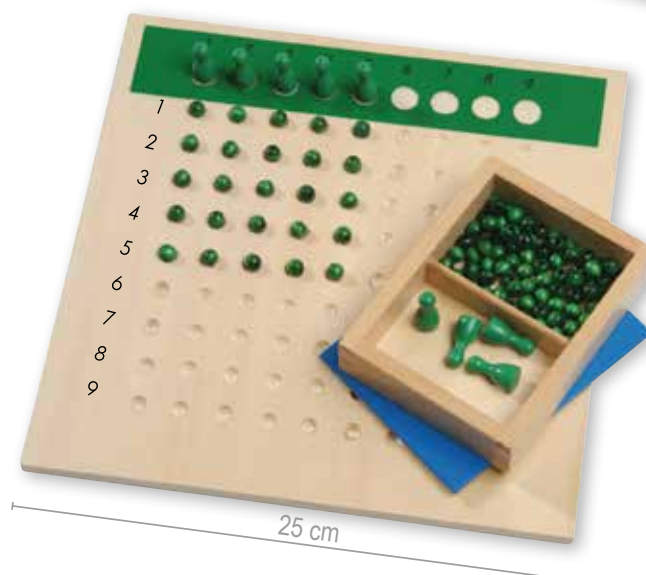

# LANGUAGE



## PRE-WRITING WALL GRAPHICS



### Set of Sandpaper Numerals

Cut-outs of the numerals from 0 to 9. They teach the numerical symbol of the quantities. This is the beginning of number writing.

Sandpaper makes the process of tracing the number more interesting and more effective in absorbing the mental image of the number.

Set of 10 boards of sandpaper numerals on a strong background (16 x 13 cm)

**85762V90**

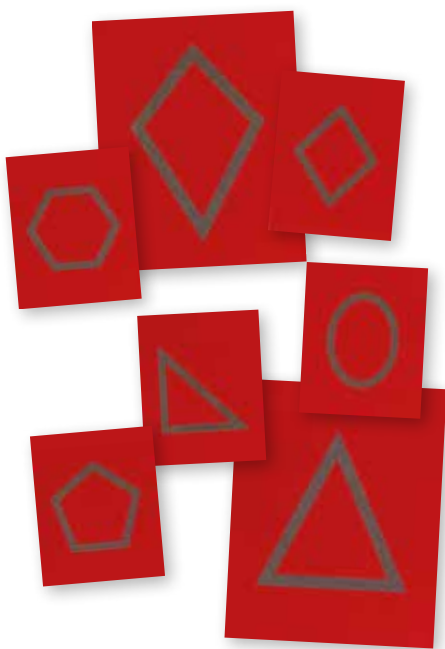

### Set of Sandpaper Shapes

Close your eyes and feel geometrical shapes. What is the difference between a rhombus and a square, between a circle and an oval?

Set of 13 boards with sandpaper shapes on a sturdy background. (16 x 13 cm), 3 triangles, 6 quadrangles, pentagon, hexagon, circle and oval

**86749V90**



### Set of Sandpaper Letters

The teaching of the sounds and letters through a multisensory approach. Children hear the sound, see its representation and feel the way how it is written with their fingers. Sandpaper letters help to develop a good pattern for handwriting.

Set of boards of sandpaper letters on a strong background (16 x 13 cm)

**85764V90** Upper Case, 29 boards

**85765V90** Lower Case, 30 boards

### Set of Sandpaper Dots

Let the children feel and count the number of dots. This way they learn to associate numbers and quantities. Use these boards together with the sandpaper numerals (85762V90). Which board of sandpaper dots corresponds to which sandpaper numeral?

Set of 10 boards of sandpaper dots on a sturdy background (16 x 13 cm)

**86739V90**



### Box for Sandpaper Letters

Comes without boards

**89394V90** Dimensions: 12 x 18.5 x 15.5 cm

### Box for Sandpaper Shapes, Dots and Numerals

Comes without boards

**89395V90** Dimensions: 6 x 18.5 x 11.5 cm

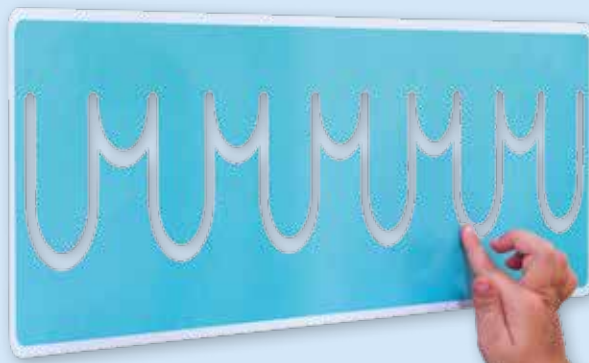

**Pre-Writing Wall Graphics**

You can place the large-format foils on all smooth surfaces, e.g. walls or cabinet doors. The rough surface awakens the children's sense of touch and invites them to feel and trace. The different patterns support those fine motor skills that are necessary for learning how to write. Made from removable film, guarantees no residues on the wall.

**In Line**

**Content:** 8 pieces  
Dimensions: 60 x 6.5 cm

**760279V90**

**In Square**

**Content:** 7 pieces  
Dimensions: 20 x 20 cm, 20 x 40 cm

**760280V90**



**MAGNETIC**

**Magnetic Grammar Symbols**

Teachers can write sentences or phrases to illustrate grammar functions and then easily symbolise them using this magnetic colour symbols first level parts of speech. The symbols have a strong magnetic backing that allows you to hold up a magnet board as you teach your lesson yet still move them easily. Students can also use the symbols for individual practice using a classroom magnet board. There are many possible uses for this set of symbols.

**ILLUSTRATE THE LAWS OF LANGUAGE**

**Basic Set**

**Content:** 20 x verb, 10 x noun, 10 x article, 10 x adjective  
Dimensions: diameter verb: 10 cm

**86984V90**

**Large Set**

**Content:** 5 x verb, 5 x noun, 5x article, 5 x adjective, 5 x adverb, 5 x pronoun, 5 x numeral, 5 x preposition, 5 x conjunction, 5 x interjection

**88419V90**

## Kamishibai Theatre

Every great story needs a stage  
Kamishibai also known as "paper theater" is an old form of storytelling which is originated in Japan.  
With Kamishibai Story Telling you can combine oral, visual, and print communications. Kamishibai is an ideal story telling method in the classroom.

Image by image is inserted into the theater. With the Kamishibai the children learn to speak freely and to let their imagination run free.

Dimensions (H x W x D): 32 x 46 x 6.2 cm

Material: plywood

Warning Notice: 2 (page 271)

**56594V90**



## Kamishibai Bag

This bag is made especially for the Betzold Kamishibai storytelling theatre and also offers space for a selection of your favorite picture cards.

The extra compartment for the picture cards can be quickly closed with Velcro®. The bag itself has a secure zipper. The bag also offers storage space for your notes.

Dimensions (H x W x D): 34.5 x 48 x 13 cm

Material: 100% polyester

**758457V90**





**Stories with Moa**

Various scenes show picture for picture different sequences of daily life of a kindergarten or school child. They are easy to understand and can be easily recognised. The pictures can be rearranged again and again and thus resulting in new storylines. It is possible for Moa to be in kindergarten as well as in school.

A fun way to develop a child's fantasy and motivate story telling. The lovingly illustrated cards encourage exact viewing and offer numerous opportunity for language skills.

The popular cards are a valuable asset for telling a chronological story, grammar lessons or learning a foreign language.

**Content:** 92 cards (9 x 9 cm), 1 manual

Material: cardboard

**54521V90**

**Scenarios**

- › Waking up and going to bed
- › Taking a bath/shower
- › Getting dressed/undressed
- › Breakfast
- › Tooth brushing
- › Going to the bathroom
- › Play and leisure time
- › Going to school/kindergarten
- › In kindergarten
- › In school
- › Lunch
- › Household chores

**Application examples**

- › Finding the correct order
- › Storyline
- › Continue the story
- › Questions and answers
- › Grammar lessons
- › Essay practice (title, beginning, main part, end)



**Card Holder**

The full story at a glance.

This holder enables more children to look at the same cards.

Wooden card holder, ca. 35 cm

**42390V90**



**A Child's Day**

Magnetic Picture Cards

Set of 26 colourful, magnetic cards featuring children actively participating in everyday routines, activities and events. The pictures are an effective tool to help children increase their expressive language skills and vocabulary by allowing them to "talk about" experiences with which they are familiar.

Dimensions: 8 x 8 cm, whiteboard not included

**87253V90**



**Story Bar**

The teacher can use the story bar to introduce or tell a story. Alternatively, children can present their story in front of the group. After a story has been told, the characters and sets can remain on the wooden stand as a reminder. A Kamishibai fits perfectly as a background. Figures are not included

Dimensions: 1.5 x 40 x 15 cm

Material: birch multiplex board

**759658V90**

**NEW**



**Combi Card Holder, set of 5**

Made from stable plastic, two-rowed, for cards, photos, notes, etc.

Stackable, optionally combinable, easy to assemble.

**Content:** 5 card holders in chosen colour  
Measurements (H x W x D): 3.5 x 8.5 x 7.5 cm

**759921V90** blue

**759922V90** green

**759923V90** red

**759924V90** orange

**759925V90** yellow

## DEVELOP SPEAKING AND LISTENING SKILLS



**Microphone Recorder**

A perfect learning aid in classroom! This allows children to use on daily basis in classrooms. Unit provides simple operating buttons enabling recording lectures and playback directly through the built-in mike or downloads to your PC using the USB connector.

- › 128 MB Memory
- › Download via USB
- › Up to 2 hours recording time
- › Batteries are rechargeable through USB
- › USB cable
- › 3.5 mm headphone socket

Warning Notice: 1 (page 271)

**84907V90**



### Writing Boards

#### Set 1: Beginners Set

- › 6 big sheets, each 36 x 30 cm, printed on both sides
- › To stimulate eye-hand coordination
- › To develop fine motor skills
- › To develop concentration
- › For right- and left-handed children

12 beautiful designs – start by following broad lines and progress to more difficult broken lines

Age: 4+

**85555V90**



#### Set 2: Advanced Set

- › 6 sheets, each 30 x 25 cm, printed on both sides
- › To stimulate eye-hand coordination
- › To develop fine motor skills
- › To practise the movements for correct letter formation
- › To develop concentration
- › For right- and left-handed children

12 exercises with different patterns which lead to correct letter formation. Start by following the lines – progress to more difficult broken lines – finish the pathways and designs.

Age: 5+

**85556V90**

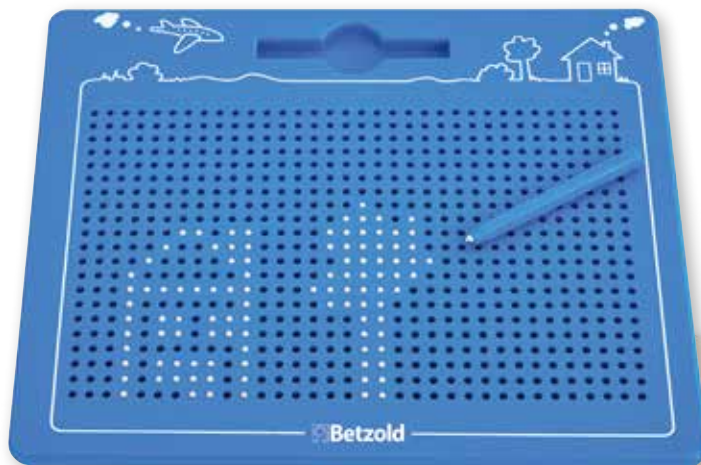
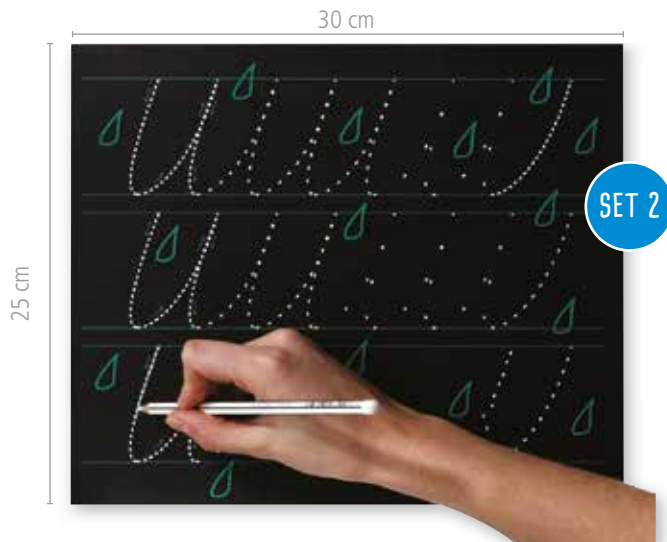

### Magnetic Drawing Board

Write with stylus, and erase with your finger.

Fine motor skills and eye-hand coordination are trained playfully and the correct posture of the pen is practiced.

Dimensions (H x W x D): 25.5 x 28 x 1.2 cm

Warning Notice: 1 (page 271)

**758161V90**

Minimum order: € 400,-



# Tellimero ≡

## Tellimero

Warning Notices: 1, 4 (page 271)

754698V90



## Tellimero ≡ – the smart way to learn

- › Motivating: With this pen children can study according to their own pace as well as their own preferences and abilities.
- › Ideal for refining language skills, learning foreign languages and therapeutic use in rehab facilities.
- › Be creative: make up your own learning material such as reading games, recording books, puzzles or photo albums. Just record the tellimero stickers individually – the pen has a memory capacity of 8 GB and 160 hours recording time.

... AND THAT'S HOW EASY IT IS:

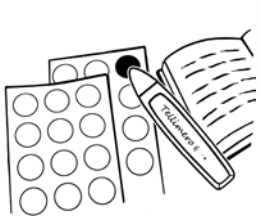

1 Attach the sticker at any position



2 Switch on Tellimero  
3 Press the Rec button



4 Select the sticker



5 Start the voice recording



6 Press the Rec button once again



7 Listen to the recordings  
8 Switch off Tellimero

winner of the

**worlddidac**  
A W A R D 2 0 1 8

- COMES WITH: SOUND STICKERS
- > 2 SHEETS WITH ANIMAL SOUNDS
- > 1 SHEET WITH INSTRUMENT SOUNDS
- > 1 SHEET WITH EMOTICONS BLANC STICKERS
- > 4 SHEETS WITH STICKERS FOR RECORDING OWN SOUNDS



### Tellimero Bag

The bag for Tellimero – the talking pen is not only chic but also practical.

Thanks to the cord, the reading pen in the bag can simply be hung around the neck and off you can go exploring. Whether through the schoolhouse, outdoors or in the sports hall.

The field of application and your imagination knows no bounds.

Dimensions (H x W x D): 15 x 4.5 x 3 cm

Material: 100% polyester

**755819V90**

### Additional Sticker Sets

Each set contains 400 stickers for individual recordings.

**755367V90** Sticker Set Red

**755371V90** Sticker Set Pink

**755368V90** Sticker Set Green

**755369V90** Sticker Set Purple

**755370V90** Sticker Set Blue

**758242V90** Sticker Set Clear

### Children's Microphone with Recording Function

The new Betzold Microphone with recording function record voices, sounds or music on the go. The microphone encourages pupils to record hear their voices and lets them forget their inhibitions.

For role plays and interviews, reading out dramas with assigned roles, listening to recordings and use in phonology.

- > Easy to use, regardless of reading ability
- > Ideal for evaluation and observation
- > Language work (preparation, presentation, reports, pronunciation training)
- > Specially designed for children

Technology and scope of delivery

Recording format: WAV file format

Capacity of the memory card: 256 MB Flash memory

Recording time: up to 4 hours

WAV bit rate: 128 kbps (Scanning 44 kHz)

Battery 3.7 V / 300 mAh Lithium-ion-polymer battery

Battery life: about 3 hours for recording or play back

Dimensions Length: 15.7 cm

Diameter: 5.7 cm (widest point)

Headphone jack: 3.5 mm

Warning Notices: 1, 4 (page 271)

**760932V90**





A n



#### Wooden Letters

53 letters from beech wood, uppercases and lowercases

Height: 5-7 cm

Thickness: 1 cm

2945V90

#### ABC Bean Bags

Great for letter recognition, word building and movement, this set of 26 bean bags features uppercase letters on one side and lowercase letters on the reverse.

Vowels are printed in red, consonants in black.

Material: bean bags: 100% cotton, storage bag: 100% polyester

Warning Notice: 1 (page 271)

36041V90

#### Wood Letter Beads

Box with 130 wooden alphabet beads. Ideal for threading. Encourages hand-eye coordination, concentration and assists with spelling.

**Content:** 130 wooden cubes (1.5 cm) printed with

uppercases, 4 laces, 1 m

Wooden box, 21.5 x 11.5 x 4.5 cm

Warning Notices: 1, 4 (page 271)

50794V90



#### Big Cloth Letters

Exploring the ABC in a fun, multisensory way. Shape size and material invite the children to touch the letters and to hold them in their hands. The form of the letters is memorised perfectly, while dealing with this ABC. This activates optical perception and tactile area.

- › Let the children follow and trace the letters
- › Lay an alphabet-street
- › Find things in the classroom, which start for example with "M"
- › Lay short words
- › Create letters with different materials

**Content:** 26 letters, height: 25 cm

Material: 100% polyester, machine washable at 30 °C

Warning Notice: 1 (page 271)

52426V90 In storage bag



**MAGNETIC**



**Remarkable Letters**

An effective exercise in getting to know letters and how to write them. The plastic letters are writeable with dry-erase markers. Without magnets.

**Content:** 26 letters with a coated surface for convenient writing

Height: ca. 11.5 cm

Warning Notice: 1 (page 271)

**86435V90**

**Magnetic Letters with Transparent Bags**

Like our plastic letters (86435V90) but with fixed magnets on the back. This way you can attach them to the board. Arrange them and demonstrate the right way of writing. The transparent bags can be connected to the letters. Fill them with all kinds of little things or pictures corresponding to the initial.

**Content:** 26 coloured magnetic letters

Height: ca. 11.5 cm, 10 transparent bags, 14 x 14 cm

Warning Notice: 1 (page 271)

**86437V90**



**First Words**

37 magnetic pictures for the letter box

Dimensions: 2 x 2 cm

**87252V90**

**Magnetic Letter Box with Small and Capital Letters**

An appealing way to practise basic reading and writing skills. Using this box will promote the learning process. Children will love to build words, sentences and short texts.

Dimensions:

Box: 31.5 x 22.5 cm (closed)

Letter tiles: height: 2 cm

**Content:**

- › Steel box with imprinted sorting field and 8 line systems.
- › 213 yellow magnetic tiles (height 2 cm) with small and capital letters and some blank spaces

**86937V90**

**MAGNETIC LETTER BOX**

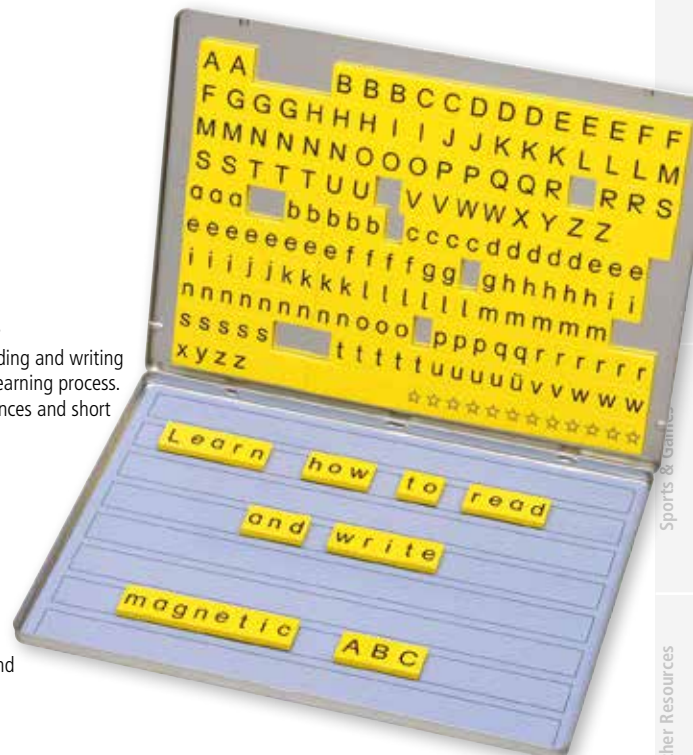

Cat



**Colourful Magnetic Letters A-Z**

Set of 52 magnetic letters from A-Z  
 26 uppercase and 26 lowercase letters  
 Height: 4.5 cm  
 Warning Notice: 1 (page 271)  
**756587V90**



Cat  
 ABC



**Magnetic Numbers**

32 magnetic numbers and 5 operation signs in a wooden box with transparent lid.  
 Dimensions: ca. 5 cm  
 Dimensions box: 5 x 16.5 x 14.5 cm  
 Warning Notice: 1 (page 271)  
**50987V90** In wooden storage box

**Magnetic Letters**

52 magnetic letters – 26 lowercase and 26 uppercase in a wooden box with transparent lid.  
 Dimensions: 5 cm.  
 Dimensions box: 5 x 16.5 x 14.5 cm  
 Warning Notice: 1 (page 271)  
**50986V90** In wooden storage box

**Magnetic Board**

Dry wipe and magnetic board with colourful plastic border.  
 All Warning Notice: 1 (page 271)  
**50858V90** Size 40 x 28 cm  
**86620V90** Size 56 x 40 cm

MAGNETIC

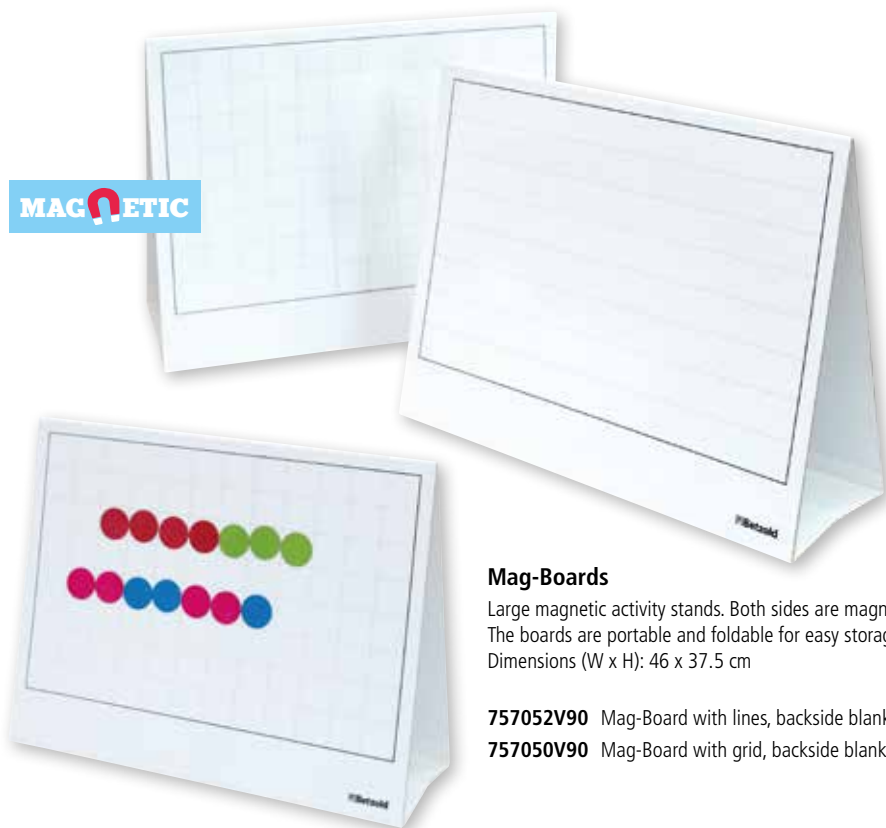

**Mag-Boards**

Large magnetic activity stands. Both sides are magnetic. The boards are portable and foldable for easy storage.  
 Dimensions (W x H): 46 x 37.5 cm  
**757052V90** Mag-Board with lines, backside blank  
**757050V90** Mag-Board with grid, backside blank



**Magnetic Picture Flash Cards**

In addition to the Magnetic Letter Case  
 The flash cards are arranged in alphabetical order to match the 26 upper case letters. A matching picture can be found for according nouns.  
 The 35 cards are made of plastic with magnetic coating the rear side.  
 Height: 12 cm  
 Flash cards are delivered in a card box with lid.  
**87271V90**



# MAGIC TOP HAT

## Motivating, fun and self-correcting

Using a given deck of cards, the child inserts the cards (question side up) into the hat, says the answer and the card is magically flipped to the answer side as it appears below.  
Height: 24 cm

87085V90

**BEST  
SELLER**



## Card Sets for the Magic Top Hat with 36 Cards each

- 40413V90 At school
- 40412V90 At home
- 40417V90 Insects & small animals
- 40423V90 Vegetables & fruits
- 40415V90 Farm
- 40420V90 Opposites
- 40425V90 What we do
- 40416V90 Food
- 40422V90 That's me
- 40426V90 Wild animals
- 40414V90 Clothes
- 40419V90 My town
- 40421V90 Prepositions



# MATHEMATICS



- 86257V90 **Addition I:** number space 20
- 86258V90 **Addition II:** number space 20
- 86259V90 **Addition III:** number space 100

- 86267V90 **Count to Ten:** amounts to 10
- 86268V90 **Count to Fifty:** amounts to 50
- 86269V90 **Time:** read the clock
- 40301V90 **Euro and Cent:** amounts in Euro and Cent up to 10 Euro
- 86270V90 **Blanc Cards**

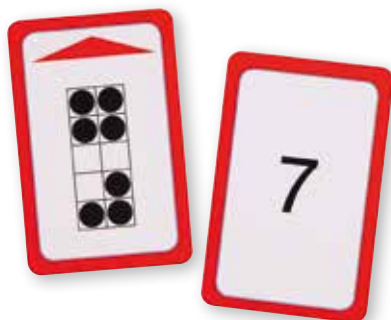

- 86260V90 **Subtraction I:** number space 20
- 86261V90 **Subtraction II:** number space 20
- 86262V90 **Subtraction III:** number space 100

- 87817V90 **Addition and Subtraction:** up to 20 without passing the 10
- 87818V90 **Addition and Subtraction:** up to 20 with passing the 10
- 87819V90 **Addition and Subtraction:** up to 100 with and without passing the 10
- 87820V90 **Multiplication and Division, Times Tables 2, 3, 4, 5, 10**

## Mental Maths – Magic Cards

Children will become a math sorcerer's apprentice using these magic cards. They solve problems and write down their results. Testing each other is fun and motivates little "math magicians". The cards are printed with tasks in black and results in red ink. Covered with the red filter card the results magically disappear. Self-correction is possible by simply removing the red filter card.

24 cards (double-sided)  
2 red filter cards  
in a transparent box

- 89506V90 Single Digit Addition (0 to 10)
- 89507V90 Single Digit Subtraction (0 to 10)
- 89509V90 Addition & Subtraction to 20 without passing the 10
- 89508V90 Addition & Subtraction to 20 with passing the 10
- 89499V90 Addition & Subtraction to 100



## MAGIC TOP HAT

### Magic Top Hat

#### Motivating, fun and self-correcting

Using a given deck of cards, the child inserts the cards (question side up) into the hat, says the answer and the card is magically flipped to the answer side as it appears below.

Height: 24 cm

87085V90

## CARD SETS FOR THE MAGIC TOP HAT WITH 48 CARDS EACH

- 86263V90 **Multiplication I:** x2, x3, x4, x5, x10
- 86264V90 **Multiplication II:** x6, x7, x8, x9
- 86265V90 **Division I:** :2, :3, :4, :5, :10
- 86266V90 **Division II:** :6, :7, :8, :9





**Cup Quizzer**

Cup made from sustainable biopolymer. Suitable for sorting games, as a rewarding system or as voting box.

**Content:** 1 cup in the selected colour  
Dimensions (H x W x D): 8 x 8.7 x 6.2 cm

Material: biopolymer

850289V90 blue

850292V90 red

850291V90 green



# CUP QUIZZER SORTING GAMES

**"True or False?"**

For one or more players

**Contents:** 10 monster cards (5x "true" with a green monster, 5x "false" with a red monster), 94 blank sorting cards for own inscription ideas (47 cards with matching solution pattern for the green monster cards and 47 cards with matching solution pattern for the red monster cards)

It requires 2-10 additional cup quizzers for this game.  
Age: 4+

759573V90



**"Calculating with Money"**

For one or more players

**Contents:** 7 task cards, 77 sorting cards  
It requires 7 additional cup quizzers for this game.

Age: 6+

761061V90



**"Quantities and Numbers"**

For one or more players

**Contents:** 10 task cards, 70 sorting cards  
It requires 10 additional cup quizzers for this game.

Age: 6+

761060V90



**"Food"**

For one or more players

**Content:** 16 task cards (8 cards front side German/back side symbol, 8 cards front side English/back side French), 88 food sorting cards

It requires 8 additional cup quizzers for this game.  
Age: 6+

759572V90

### Plastic with that 'Certain Something'

Our Betzold treeNside material trays are filled with nature – you can see and even smell it! Test it out! They are produced in our own manufacture. We use organic plastic granulate made from wood fibres for their production. The materials are biobased. The robust treeNside material trays can be used in

schools, kindergartens, in the office or at home. They are made for organising, storing and sorting or as a container for liquids, such as flourishing water or paste. We recommend the cleaning by hand with water and detergent.



#### Sorting Trays, small, Set of 5

Dimensions (H x W x D): 2.6 x 18 x 12 cm  
**Content:** 5 material trays each per colour

- 758887V90 Nature
- 758888V90 Yellow
- 758889V90 Orange
- 758890V90 Red
- 758891V90 Pink
- 758892V90 Purple
- 758893V90 Blue
- 758894V90 Green



#### Sorting Trays, large, Set of 5

Dimensions (H x W x D): 4.7 x 23 x 14.7 cm  
**Content:** 5 material trays each per colour

- 758897V90 Nature
- 758898V90 Yellow
- 758899V90 Orange
- 758900V90 Red
- 758901V90 Pink
- 758902V90 Purple
- 758903V90 Blue
- 758904V90 Green



#### Sorting Trays

##### Set of 6 Small Sorting Trays in 6 Colours

850111V90 2.6 x 18 x 12 cm

##### Set of 6 Large Sorting Trays in 6 Colours

850112V90 4.7 x 23 x 14.7 cm



#### Sorting Trays, small, Set of 6

Dimensions (H x W x D): 2.6 x 18 x 12 cm  
**Content:** 1x yellow, 1x orange, 1x red, 1x blue, 1x green and one of three colours of choice:

- 850255V90 Set with Nature
- 850272V90 Set with Pink
- 850274V90 Set with Purple



#### Sorting Trays, large, Set of 6

Dimensions (H x W x D): 4.7 x 23 x 14.7 cm  
**Content:** 1x yellow, 1x orange, 1x red, 1x blue, 1x green and one of three colours of choice:

- 850253V90 Set with Nature
- 850273V90 Set with Pink
- 850275V90 Set with Purple



**BEST SELLER**



#### Dice Case

162 colourful dice for practising numeracy. The different types of dice offer a variety of applications.

#### **Content:**

plastic case with 162 dice with arithmetic operators, dots, numbers

Warning Notice: 1 (page 271)

**82054V90**



### Small Sand Timers, Set of 4

**Content:** 4 sand timers 30, 60, 120 and 180 seconds  
Height: 9 cm

Warning Notice: 1 (page 271)

**85283V90**



### 20 Sand Timers

How long is a break of 5 minutes? How long are 30 seconds if you are standing on one leg? Make time visible and let children experience time. Sturdy case with 20 sand timers.

4 sand timers of each time: 10 min. (red), 5 min. (green), 3 min. (yellow), 1 min. (blue), 30 sec. (black)

Warning Notice: 1 (page 271)

**86518V90** Set with 20 sand timers



### Wooden Pawns

Height: 2.7 cm, diameter: 1.5 cm  
All Warning Notice: 1 (page 271)

**1861V90** 20 pieces red

**1862V90** 20 pieces yellow

**1863V90** 20 pieces blue

**1864V90** 20 pieces green



### Wooden Pawns

Height: 4 cm, diameter: 1.9 cm  
All Warning Notice: 1 (page 271)

**1868V90** 20 pieces red

**1869V90** 20 pieces yellow

**1870V90** 20 pieces blue

**1871V90** 20 pieces green



### 5 Sandtimers

Time becomes visible. How long are 30 seconds, 1 minute, 3 minutes, 5 or 10 minutes? Children develop their sense of time while handling sandtimers.

The coloured lids and sand make different time periods easily distinguishable. Height: 9 cm, diameter: 2.5 cm

Warning Notice: 1 (page 271)

**42041V90**



### Transparent Counters

Made of sturdy plastic. Diameter: 2 cm  
All Warning Notice: 1 (page 271)

**1887V90** 250 pieces red

**1888V90** 250 pieces yellow

**1889V90** 250 pieces blue

**1890V90** 250 pieces green

### Counters

Made of sturdy plastic. Diameter: 2 cm  
All Warning Notice: 1 (page 271)

**1880V90** 250 pieces red

**1881V90** 250 pieces yellow

**1882V90** 250 pieces blue

**1883V90** 250 pieces green



### Counting Dice

Set of 9 dice to train addition, subtraction and multiplication tables.

Warning Notice: 1 (page 271)

**42978V90**

### Counting Dice

Provide training in the four operations till 100. Red dice with 5 numbers and one blank side.

Blue dice with symbols +, -, x, :, <, >

#### Content:

4 dice 1 to 5, 4 dice 6 to 10, 4 dice 11 to 15, 4 dice 16 to 20, 4 dice with operation signs +, -, x, :, <, >

Warning Notice: 1 (page 271)

**85107V90** Set of 20 dice

### Blank Dice

Surface can be written on with a special marker

All Warning Notice: 1 (page 271)

**1819V90** 10 dice, 1.8 cm

**1820V90** 10 dice, 2 cm

**1822V90** 6 giant dice, 3 cm



### Wooden Dice with Dots

All Warning Notice: 1 (page 271)

**1621V90** 10 dice, 1.8 cm, red

**1622V90** 10 dice, 1.8 cm, yellow

**1623V90** 10 dice, 1.8 cm, blue

**1624V90** 10 dice, 1.8 cm, green



### Foam Dice with Dots

A quiet classroom tool. Easy to see for demonstrations and easy for small hands to pick up. Soft, safe and easy to read.

Warning Notice: 1 (page 271)

**35453V90** Set of 3 dice, 5 cm



**NEW**



**Silent soft dice**

No more disturbing noise while playing with dice! Made of washable, durable soft yellow foam.  
All Warning Notice: 1 (page 271)

- 759508V90** Set 10 pcs in polybag
- 759711V90** Set 200 pcs, with storage box

**Giant Plastic Dice**

A series of dice, all made of heavy duty plastic. Size about 10 cm. Easily visible by a group of children. Land silently when thrown. To be used for counting exercises.  
All Warning Notice: 1 (page 271)

- 35459V90** Number Dice 1–4 (tetrahedron)
- 35461V90** Number Dice 1–8 (octahedron)
- 35462V90** Number Dice 0–9 (decahedron)
- 35463V90** Number Dice 1–12 (dodecahedron)
- 35460V90** Dots Dice Blue – with indented dots
- 35484V90** Dots Dice Red – with indented dots
- 35491V90** Number Dice Green 1–6
- 35966V90** Coloured Dice



**Giant Foam Number Dice**

with a very durable and soft texture and indented numbers 1–12  
These dice are made like foam balls. Numbers are printed very clearly. Very easy to handle. They land silently when thrown.  
Team dice with numbers 1–12, size: 10 cm, weight: 75 g  
All Warning Notice: 1 (page 271)

- 35469V90** Yellow
- 35467V90** Red
- 35468V90** Blue

**Big School Dice – Size: 20 cm**

With the numbers 0–10 and a joker. Made of heavy duty foam with a non-toxic plastic coating (elephant skin). Numbers are very clearly printed. Can be used for all kinds of activities in class or outside.  
All Warning Notice: 1 (page 271)

- 1695V90** Red
- 1696V90** Blue
- 1697V90** Green
- 1698V90** Yellow





**Floor Number Tiles**

Set of 21 large floor number tiles for floor use – with a non-slippery surface. Dimension: 30.5 x 30.5 cm  
Age: 24 M+  
**33980V90**

**Floor Number Tiles**

Set of 21 large floor number tiles in a sturdy box  
Age: 24 M+  
**87836V90**

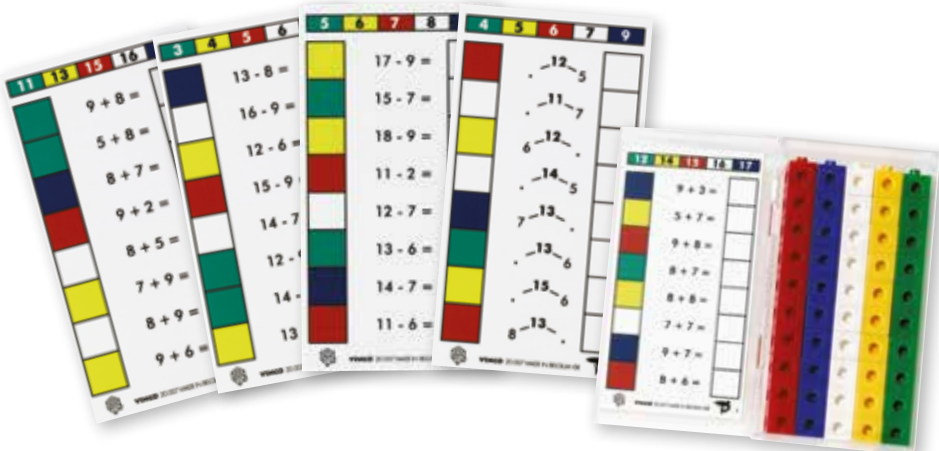

**Cube Control**

An unique, cheap and simple self-correcting system. Children have to find the right answer on one of the cubes on top for the exercise. They build a tower completing the exercise. The colour sequence of the tower has to be compared with the colour sequence of the pattern on the reverse side. The exercise cards are printed on plastic.

**Content:**  
Plastic box with 50 interlocking 2-cm-cubes in 5 colours  
Warning Notice: 1 (page 271)  
**85547V90** Set

**Sets**

1 set has 5 cards. Each card has 16 questions – 8 on each side.

- 85548V90** Set 1: Exercises up to 5
- 85549V90** Set 2: Exercises up to 10
- 85550V90** Set 3: Exercises up to 20 without passing of 10
- 85551V90** Set 4: Exercises up to 20 with passing 10
- 85552V90** Set 5: Exercises up to 30
- 85553V90** Set 6: Exercises up to 100
- 85740V90** Set 7: + and - up to 100
- 85741V90** Set 8: x and : 2/5/10
- 85742V90** Set 9: x and : 2/5/4/8
- 85743V90** Set 10: x and : 3/6/9
- 85744V90** Set 11: x and : 4/7/8/9
- 85745V90** Set 12: x and : mix

The sets can be easily stored in the plastic box with the cubes.  
Plastic box (can be bought separately)

**85554V90** Box

**EXERCISE**

**CONTROL**

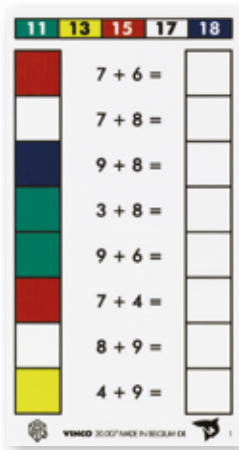
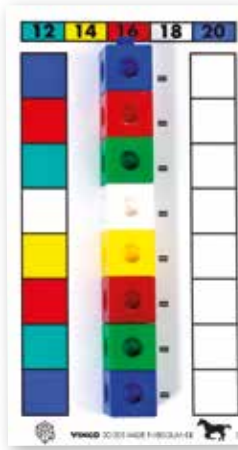
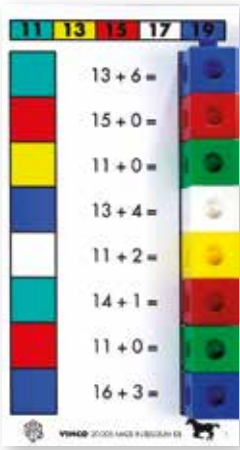



**NEW**



### Dice Bubbles

Randomly ask addition and subtraction problems! Each hemisphere contains 2 number dice (1-6) and an addition and subtraction dice (+ and -).

Dimension: Ø 10 cm

Warning Notice: 42 (page 271)

**759552V90** Set of 4

### Pocket Dice

Create your own dice with the vinyl covered soft dice. Just put pictures or word cards in the clear pockets. The exchangeable cards make this cube versatile and suitable for all ages and abilities.

Age: 24 M+

Available in 2 sizes:

**86900V90** Pocket Dice, 10 cm (for cards max. 9 cm)

**86901V90** Pocket Dice, 16 cm (for cards max. 15 cm)



### Work Cards Pocket Dice, large

Set of 41 cards – 35 printed on both sides in black and white and 6 coloured cards. To put in the pocket of the dice.

Subjects: numbers in different ways, emotions, spatial awareness, counting operations, animals, geometric forms, body parts, question marks, everyday objects

Dimensions: 13.5 x 13.5 cm

**86619V90**



### Sign "Spinning Arrow"

- › Magnetic, for blackboards
- › Suitable for all subjects

All eyes eagerly watch where the spinning arrow will come to stop. Who knows the answer? Assign a task to each math lesson (addition, subtraction, multiplication and division). With funny arrows you are sure to attract attention in the whole class room. Can also be applied in language and grammar lessons as well as a story telling method. Also a good method to select class chores. Set with 3 colourful spinning arrows (each 17 cm) made of coated cardboard with plastic mounting and rear magnet.

**89902V90**



Minimum order: € 400,-



**BEST  
SELLER**

## MAGNETIC PICTURES FOR COUNTING AND CALCULATING

Elementary instructions with funny and colourful pictures. How many horses do you see? Are more boys or more girls at home?

6 planes are standing at the airport, 3 already took off. How many planes were there before?

**Content:** 196 magnetic pieces in sturdy cardboard box: 140 pictures (always 10: apples, pears, bananas, cows, horses, dogs, cats, balloons, cars, bicycles, ships, planes, girls and boys), size: 13 cm  
42 numbers (twice: 0–20), size: 5.3 x 5.3 cm  
14 operation cards (twice: +, -, \*, /, <, >, =), Dimensions (W x H): 5.3 x 5.3 cm

**82177V90**



### Scale

In combination with this scale one can make simple comparisons and all kinds of simple operations.  
Warning Notice: 1 (page 271)

**85032V90**



### Counting Bears

This set includes 96 counting bears in 3 sizes and 4 colours. The bears weigh between 4 and 12 g.

To reinforce early learning concepts as colour, number, size, and weight.

Warning Notice: 1 (page 271)

**761792V90** In plastic box with lid





**MAGNETIC**

**Number Line up to 10**

Colourful material that enables children to build a stable quantity-number connection. Scope of delivery: 2 boards of stable, coated cardboard, magnetic (30 x 47 cm), 10 number cards black and white (7 x 7 cm), 10 number cards, coloured (7 x 7 cm), 10 cards with dwarves (7 x 7 cm), 10 cards with quantity pictures (7 x 7 cm), 10 cards with ordered set pictures (7 x 7 cm), 10 cards with finger numbers (7 x 7 cm), 10 cards with dice (7 x 7 cm)

Warning Notice: 1 (page 271)

**758458V90**



**Cuisenaire Rods**

Colourful wooden blocks ranging from 1 cm to 10 cm lengths. They're great for creating patterns, counting, sorting, measuring, adding, multiplying, and all sorts of other fun explorations.

Also very useful in combination with the Rod Track (see page 90)

**Cuisenaire Rods, small set**

**Content:** 74 pieces

Warning Notice: 1 (page 271)

**85823V90** In polybag

**Cuisenaire Rods, large set**

**Content:** 300 pieces

Warning Notice: 1 (page 271)

**756641V90** In wooden box with transparent lid

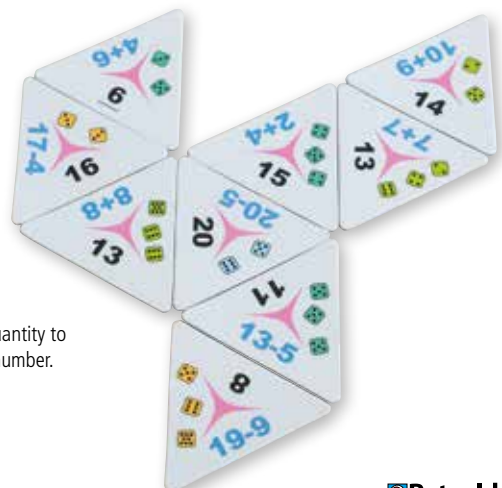

**Tri-Domino Up to 12**

An exciting matching game. Practice matching quantity to number, number to number and quantity to quantity. 2-4 players

**Content:** 30 triangle domino tiles (24 printed & 6 white)

**760363V90**

**Tri-Domino Up to 20**

Exciting matching games. Practice matching quantity to quantity, number to number and quantity to number. 2-4 players

**Content:** 30 triangle domino tiles

**760364V90**

Minimum order: € 400,-



### Multi-Split XXL

The large scale box enables you to get your pupils' attention, to show and explain first arithmetic problems. The green box can be used with two different transparent insets. One inset offers 2, the other one 3 sections to practise numeracy with 2 or 3 summands.

Dimensions box (H x W x D): 21.5 x 33.5 x 4.5 cm with 10 beads Ø 3 cm

Lid to cover the hidden beads (H x W x D):

21.5 x 33.5 x 4.5 cm

Warning Notice: 5 (page 271)

**87155V90**



### Multi Split

#### To set up and satisfy equations

The green box can be used with two different transparent insets. One inset offers 2, the other one 3 sections to practice numeracy with 2 or 3 summands. Choose one inset and shake the balls. After counting the visible beads, set up an equation and calculate the covered subset. By sliding the lid and counting the uncovered beads the box is self-correcting.

**Content:** 1 green box (1.7 x 7.3 x 4.7 cm) with 1 green lid, 2 transparent insets, 10 beads  
Warning Notice: 5 (page 271)

**85913V90**

### 50 Replacement Beads

Warning Notice: 5 (page 271)

**85917V90** In a plastic bag



### Big Cloth Numbers

These soft numbers provide a playful introduction to the world of numbers. Where is the cuddly three and who has got the fluffy nine? Come on and enjoy numbers, counting, and calculating games!

**Content:** 10 numbers from 0 to 9, height: 27 cm  
Material: 100% polyester, machine washable at 30 °C  
Warning Notice: 1 (page 271)

**53881V90** In storage bag

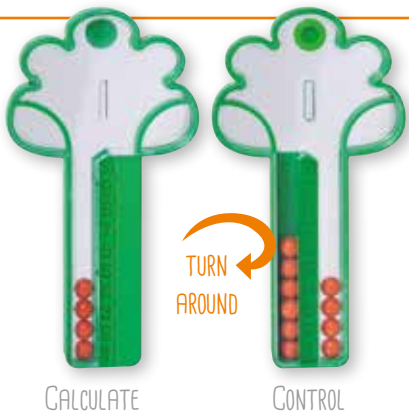

# SHAKE THE TREE

**BEST  
SELLER**



## Shake the Tree

... and ten "apples" will split into two collecting tubes, each with a scale. On the front side of the tree you can only see the content of one tube. Set up an equation and calculate the covered subset. By turning it around the tree is self-correcting. Due to the press-lock you can vary the number of "apples".

### Content:

1 plastic tree (height 12 cm), 10 plastic beads  
All Warning Notice: 5 (page 271)

**86700V90**

**85917V90** 50 Replacement Beads

## Shake the Tree – Stamp

A great complementation to the trees: stamp in your exercise book, shake the tree and draw the visible beads in one column. How many beads are missing? Draw them in the other column.

Size: 6.8 cm

Warning Notice: 1 (page 271)

**40384V90**

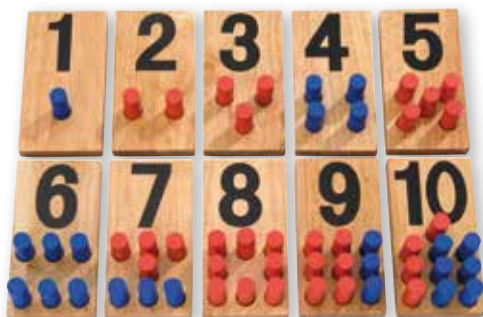
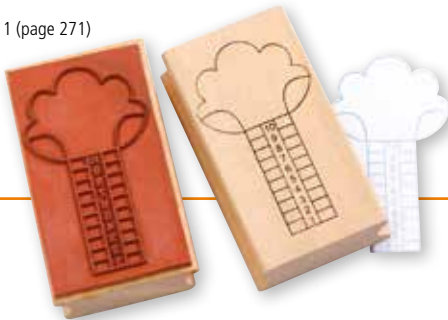

## Peg Number Boards with Blue and Red Sticks

By fitting the pegs into the board kids learn to associate a figure with an adequate number. First adding, subtractions and explements can be visualised.

Set with 10 boards, 55 red and 55 blue pegs

Warning Notices: 1, 2 (page 271)

**85524V90**



Minimum order: € 400,-



**Math's Balance Demo**

Dimensions (W x H): 65.5 x 22 cm  
 You can hang 20 weights on the pegs along the balance.

- The balance can be adjusted.
- Includes 20 x 10 g weights.
- > To study simple additions, subtractions, missing numbers ...
- > To study multiplications and divisions.
- > To learn the concept of balance and levels.

When the balance scale is in balance, the answer is correct!

Warning Notice: 1 (page 271)

**2467V90**

**Student Math's Balance**

33 cm wide, 11 cm high  
 You have the possibility to provide a balance scale for every child in your group.

Warning Notice: 1 (page 271)

**2280V90**

**Monkey Math**

Monkey Math makes addition fun! Just hang an equal number of bananas on each of the monkey's hands. If you have done your addition correctly, the monkey will look straight ahead and his arms will be balanced perfectly. If the numbers are not equal, his eyes will be crossed and his arms will be up and down.

Height: 18 cm

Warning Notice: 1 (page 271)

**50698V90**

# GREATER-LESS-MONSTER



**MAGNETIC**



**Greater-Less-Monster**

Math can be fun. This little monster is really hungry and likes to eat numbers. If it has the choice it prefers the greater one. If the numbers are equal it can't decide. The greater, less and equal signs in red are already included in the monster.

So it is easy for the children to understand the symbols.

The set consists of 4 greater-less-monsters, printed on both sides, ca. 14.5 x 16 cm  
 2 equal-monsters, printed on one side, ca. 15 x 16 cm  
 2 big cakes, ca. 7 x 8 cm  
 2 small cakes, ca. 4 x 4.5 cm  
 Made out of magnetic foil

**88462V90**

**Set of 20 trays  
incl. 200 reversible counter tiles**

Durable tray with raised edges keeps each counter in place. Double-sided 2-colour counters support visual learning of number bonds.  
Tray size (W x H) 6.6 x 16.5 cm, diameter tiles: 2.5 cm  
Warning Notice: 42 (page 271)

**759554V90**



**1, 2, 3 ... Whee! Magnetic Counting Box**

with numbers, arithmetic operators and bicoloured counters.  
An appealing way to practise basic calculating skills.  
Using counters and numbers children will gain more and more sureness while doing number work.

**Content:**

1 steel box with sorting field, 2 counter fields for exercises in the number range of twenty, 1 calculating field.  
39 magnetic counters, Ø 2 cm  
92 yellow magnetic tiles with numbers and operators (4x numbers from 0 to 9, 2x numbers from 10 to 20, always 6 operators +, -, =, <, >)  
16 blank magnetic tiles

**86936V90**

1, 2, 3 ...  
WHEE!



SET 1

SET 2

**BEST  
SELLER**

**Work Cards for the Counting Box**

To learn and practice counting to 20. 2 different sets with each 6 cards (31 x 8 cm) printed on both sides

**Set 1:**  
12 exercises per card (72 exercises in total)  
2 cards + (addition)  
2 cards - (subtraction)  
2 cards <, > (more or less)

**87231V90**

**Set 2:**  
18 exercises per card (108 exercises in total)  
3 cards + (addition)  
3 cards - (subtraction)

**87232V90**

$$14 + 3 =$$

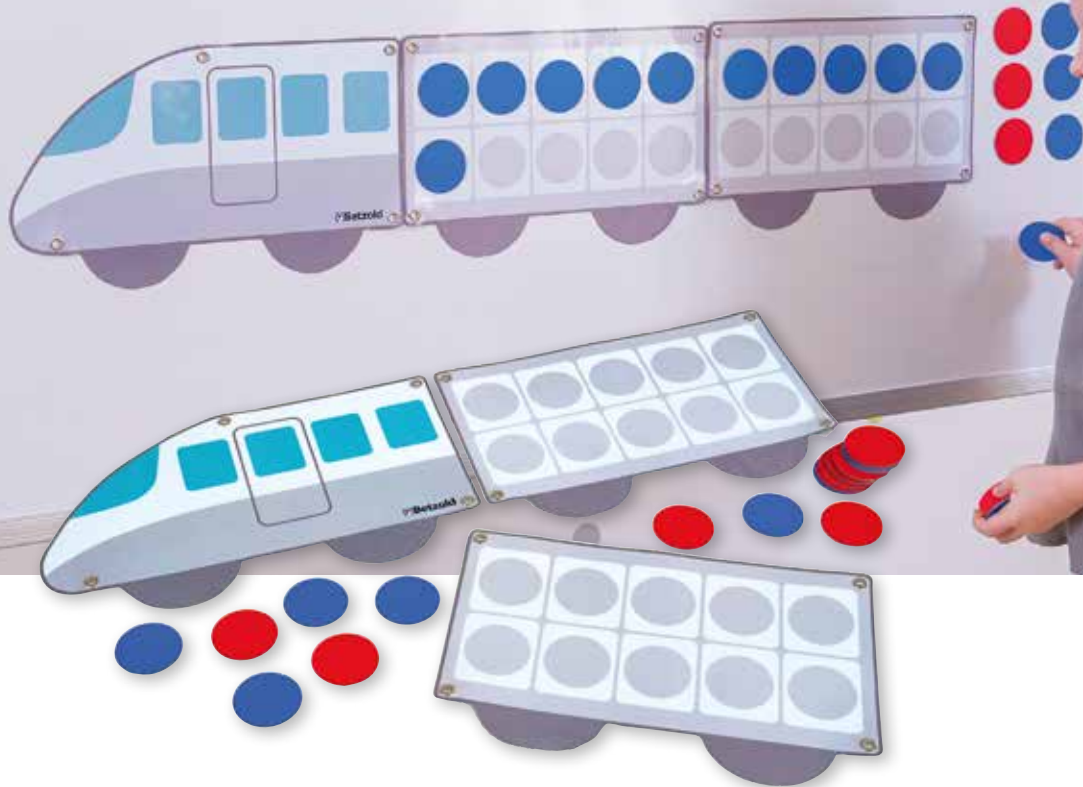

### Arithmetic Train – Magnetic Board Material

With 20 reversible tiles in blue/red that represent the passengers. Each wagon offers space for 10 tiles.

**Content:**  
1 locomotive, 2 wagons, 20 reversible tiles, 1 handout  
**760718V90**

### Wooden Arithmetic Train 20

2 wagons with space for 10 passengers each. Gives children a clear impression of the number range up to 20.

**Content:**  
locomotive, 2 wagons, 10 red passengers, 10 blue passengers  
Size (H x W x D): 7.5 x 35.5 x 5.5 cm  
Warning Notice: 1 (page 271)

**759883V90**

### Wooden Arithmetic Train 100

**Content:**  
locomotive, 10 wagons, 50 red passengers, 50 blue passengers

Size (H x W x D): 7.5 x 141 x 5.5 cm  
Warning Notice: 1 (page 271)

**759884V90**

**NEW**





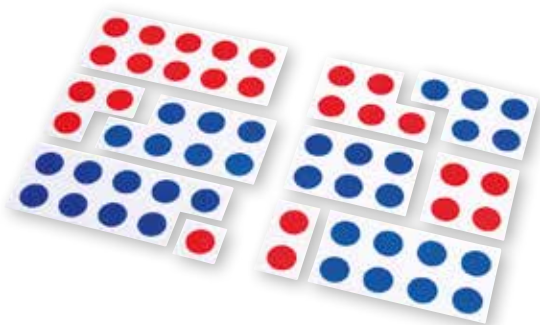

### Dot Cards

These dot cards illustrate numbers from 1 to 10, and are therefore useful devices for developing number sense within the context of 10. They enable children to automatically think of numbers less than 10 in terms of their relationship to 10 and to build a well-grounded knowledge of the basic addition/subtraction facts for 10 which are an important part of calculation. The dot cards are printed on both sides – one side with blue dots, the other side with red dots.

#### Dot Cards Demo, magnetic for demonstration

Size: max. 27 cm

**85958V90** Set of 12 pieces

#### Student Dot Cards, made of sturdy plastic

Size: max. 14.5 cm

**85957V90** Set of 12 pieces

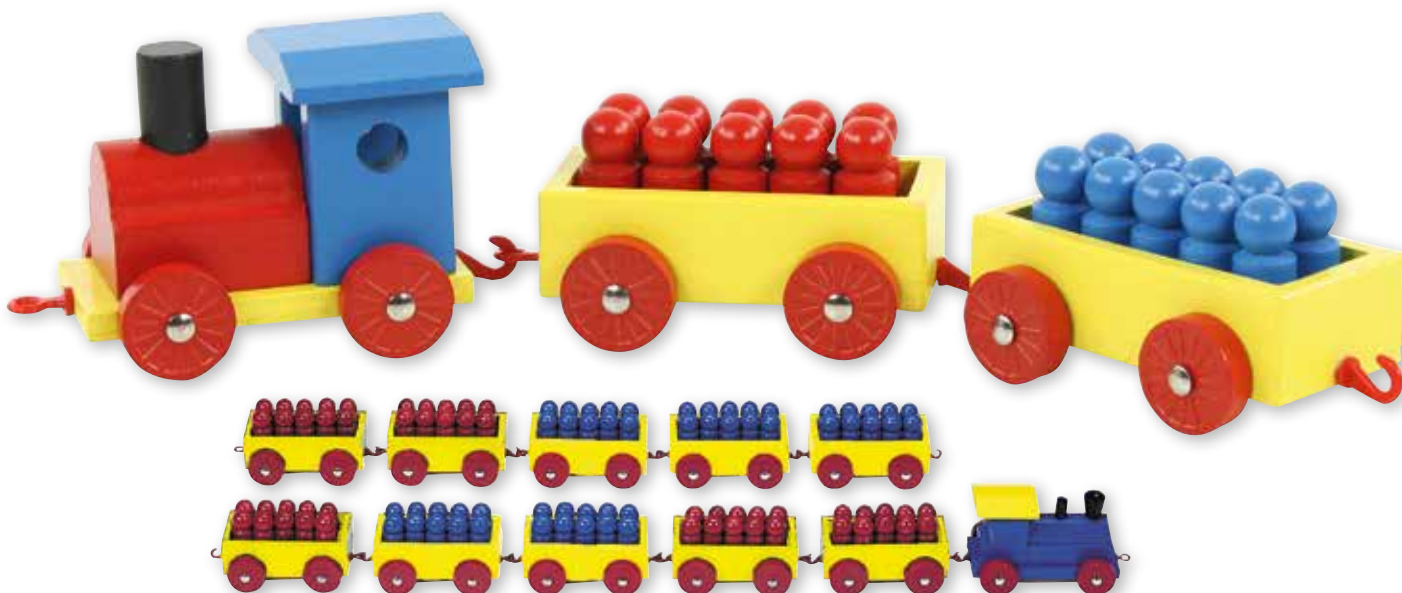

### Counting Trains

In each carriage (12 cm) you find 10 passengers (4.5 cm high). The passengers from both carriages have a different colour.

The children learn counting operations by practising (e.g.: getting in and out of the train).

Suitable for each method!

### Counting Train to 20

**Content:** 1 locomotive, 2 carriages, 20 men (10 red, 10 blue) red/blue

Warning Notice: 1 (page 271)

**1363V90**

### Counting Train to 100

For all counting operations to 100

**Content:** 1 locomotive, 10 carriages, 100 men (50 red, 50 blue) red/blue

Warning Notice: 1 (page 271)

**1364V90**



### Train Stamper

To stamp 1 or more carriages. Children colour the circles and count that way.

Dimensions (H x W x D): 2.2 x 6.5 x 3.5 cm

Warning Notice: 1 (page 271)

**88260V90**

### Worksheets for the Counting Train

These funny exercises go together with the counting train.

For counting to 10 and to 20 – different exercises:

- > sorting, addition & subtraction
- > colour exercises to develop fine motor skills.

Children can use the train while trying to find the solutions – i.e. from concrete to abstract.

32 copy work sheets

**85378V90** French version



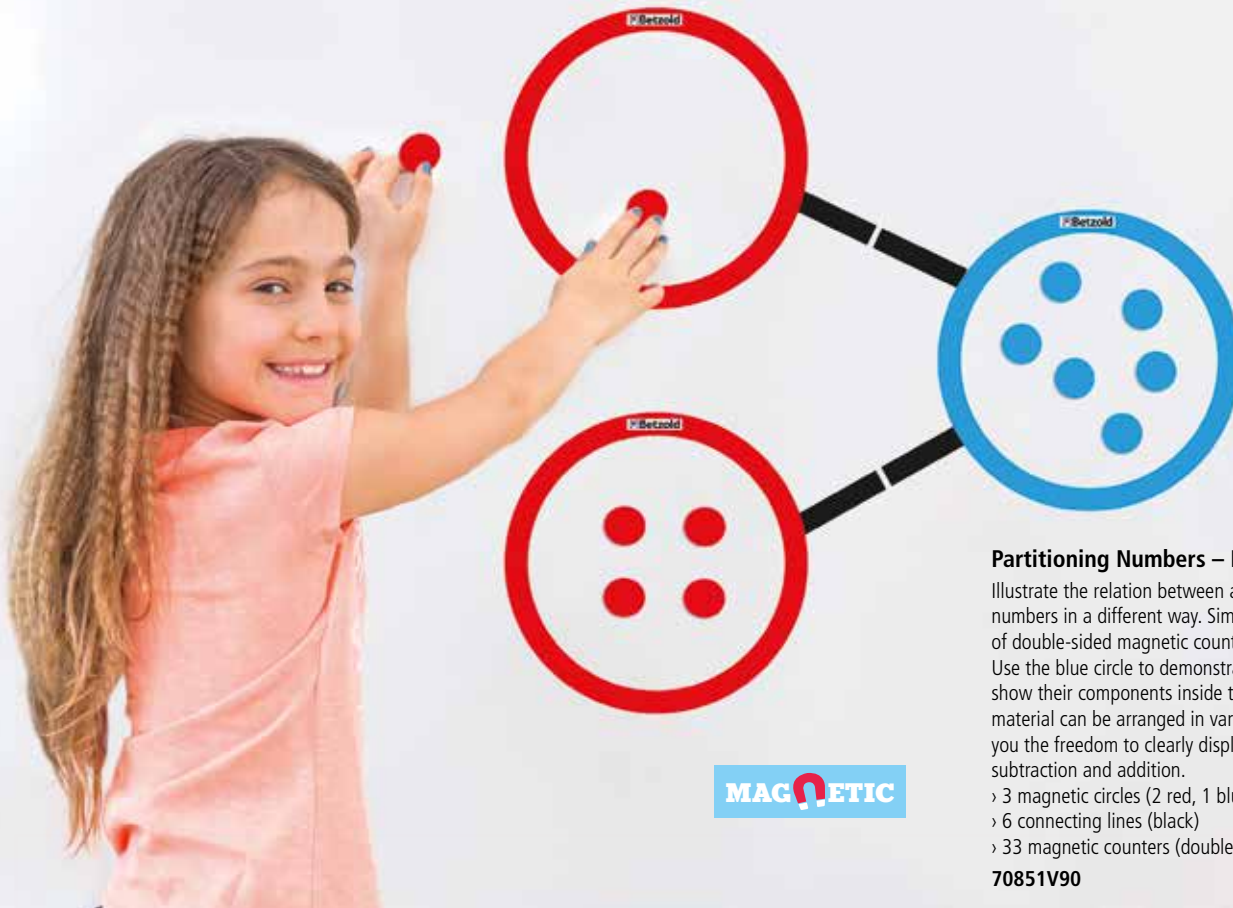

**MAGNETIC**

### Partitioning Numbers – Magnetic Materials

Illustrate the relation between and partitioning of numbers in a different way. Simply change the amount of double-sided magnetic counters used in each circle. Use the blue circle to demonstrate whole numbers and show their components inside the red circles. Magnetic material can be arranged in various directions, giving you the freedom to clearly display the concepts of subtraction and addition.

- › 3 magnetic circles (2 red, 1 blue)
- › 6 connecting lines (black)
- › 33 magnetic counters (double-sided)

**70851V90**

## BRING HANDS-ON-LEARNING INTO THE CLASSROOM

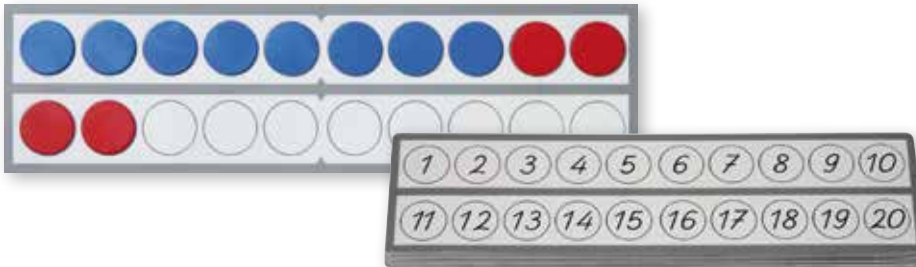

### Numeracy Board for Counters

Use the counters together with our boards. Always having the number space (up to 20) visible, the children will gain basic calculating skills easily.

The boards are made of solid plastics, 1 mm strong and 30 cm long. On the one side are circles with numbers, on the other side are blank circles. The diameter of the circles is the same as the size of the counters.

Examples of use:

- › Passing 10
- › Addition
- › Subtraction
- › Even and odd numbers
- › Cover numbers and search for them
- › Number series

**85969V90** Set of 10



### Class Pack with 400 Counters

Ø 25 mm, red/blue

Warning Notice: 1 (page 271)

**1669V90** In plastic box

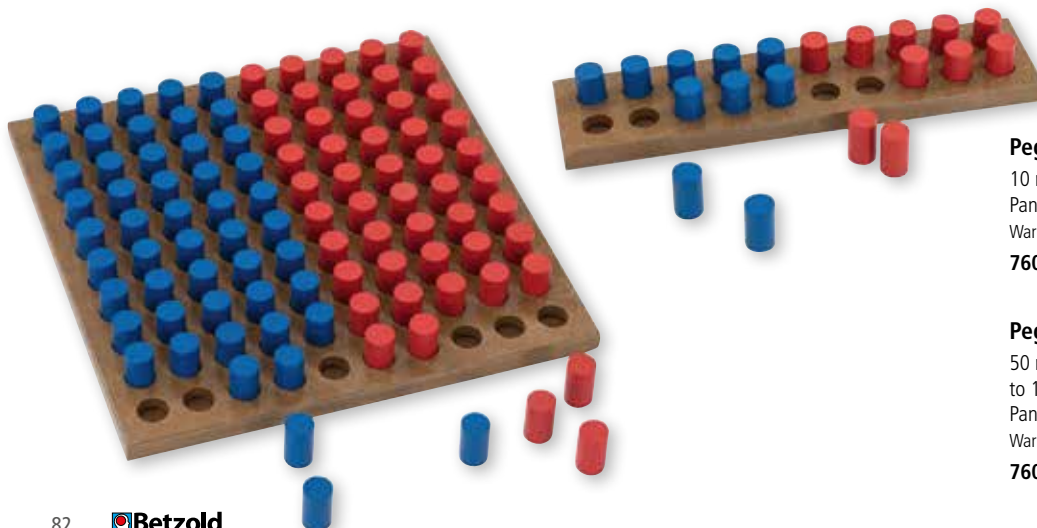

### Peg Number Panel, to 20

10 red and 10 blue pegs for calculations up to 20.

Panel: 1.2 x 25 x 6 cm, 20 pegs (height: 2.5 cm)

Warning Notices: 1, 2 (page 271)

**760650V90**

### Peg Board up to 100

50 red and 50 blue for counting and calculating up to 100.

Panel 25 x 25 cm, 100 pegs (height: 2.5 cm)

Warning Notices: 1, 2 (page 271)

**760651V90**

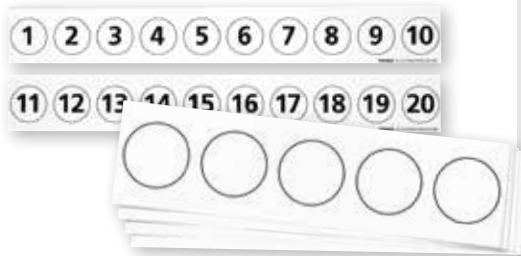

### Magnetic Demo Board for Counters

This set consists of:  
 4 boards with 5 blank circles (each 30 x 8 cm)  
 1 board with circles 1–10 (60 x 8 cm)  
 1 board with circles 11–20 (60 x 8 cm)

Made of plastic foil  
 While the blank boards have 5 circles, they can be used as demo for the 'Counting Train'. (See page 81)

85738V90

### Magnetic Demo Set

**Content:**  
 Magnetic Demo Board (85738V90)  
 20 magnetic counters (81930V90)  
 20 magnetic rings (86234V90)  
 87031V90



### Magnetic Demo Set

Stripes and counters are both made of magnetic foil. So it is very easy to fix the stripes on the board.

**Content:**  
 4 boards with 5 blank circles (each 30 x 8 cm)  
 1 board with circles 1–10 (60 x 8 cm)  
 1 board with circles 11–20 (60 x 8 cm)  
 As the blank boards have 5 circles, they can be used as demo for the 'Counting Train'. (See page 81)

41049V90

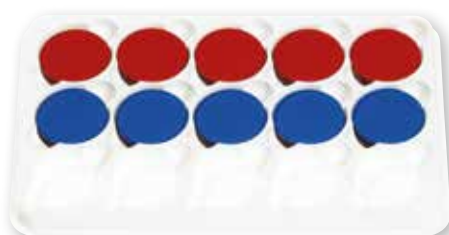
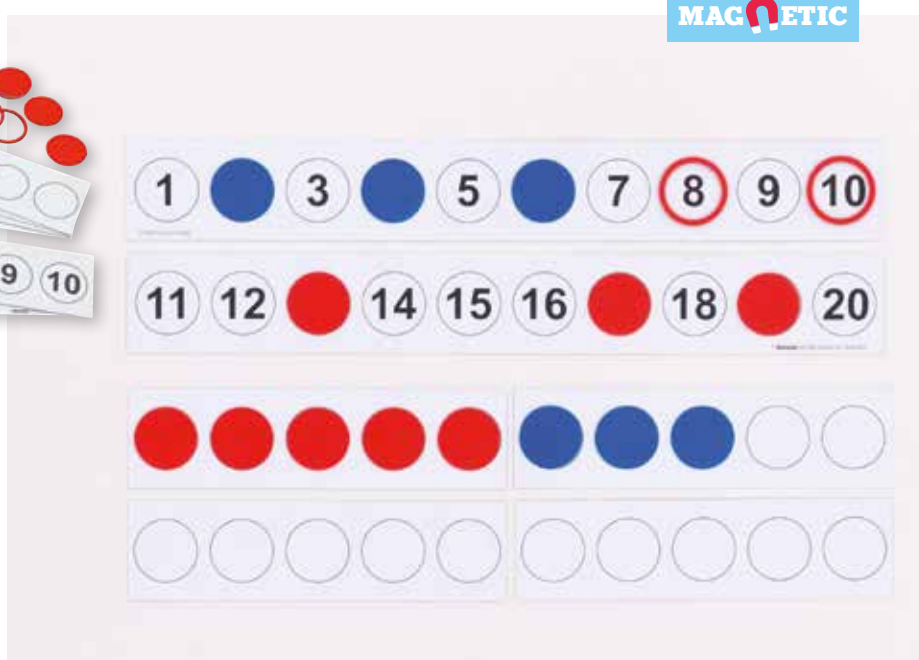

### Sorting Tray with 100 Counters

85062V90 Ø 5 cm, red/blue

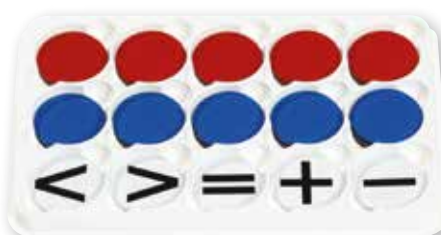

### Sorting Tray with 100 Counters & Signs

1756V90 Ø 5 cm, red/blue with 20 counting signs



Set of 20 Bicoloured Magnetic Rings, 5.5 cm Ø, red/blue  
 81930V90

Set of 20 Bicoloured Magnetic Counters, 5 cm Ø, red/blue  
 86234V90

Minimum order: € 400,-



**Basics Board with Colourful Tags**

A new way to experience the times table. Each series has its own colour, related series are similarly coloured (5 and 10 – green; 2, 4 and 8 – red; 3, 6 and 9 – yellow). To show problems of one series and to set them in relation to other series.

Board (71 x 71 cm), aluminium frame with rounded angles. Multipliers and a grid are printed on the board.

Assortment box with 100 colourful double-printed tags showing problems and solutions.

**86940V90**

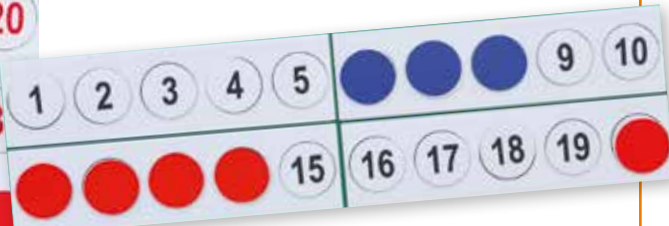
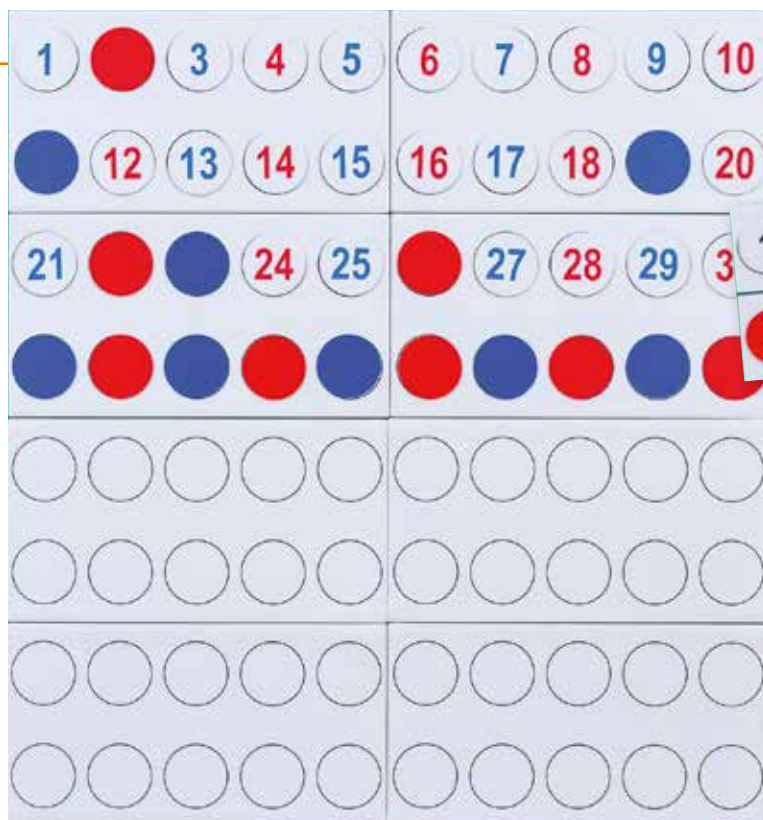

**Number Range 100 – magnetic material for the blackboard**

The magnetic stripes with 5 or 10 empty fields allow the composition of a field up to 100 in different manners. The stripes can be fixed in 4 field sections with 25 circles each (Oehl) or in 10 sections with 10 circles each (Kuehnel) on the blackboard. For working with smaller number ranges it is possible to use only a part of the magnetic stripes. Computing operations in the non-numerical area can be shown with the blue and red magnetic circles.

Some magnetic circles are printed with blue and red numbers, multiplication table numbers and arithmetic operators for the computation with numbers. By means of this set it is possible to learn and to practice computing operations in the number range 0–100.

**Content:**

- › 8 magnetic stripes with 10 circles each
- › 4 magnetic stripes with 5 circles each
- › 100 turning pads with black numbers 0–100
- › 100 red turning pads with white numbers 1–100
- › 50 red turning pads
- › 50 blue turning pads
- › 100 red numbers 1–100
- › 100 blue numbers 1–100
- › 28 arithmetic operators (+ - \* : = <)

**755804V90**





**MAGNETIC**

**Magnetic Number Line 0–20**

With magnetic symbols, counters, rings and counter boards

Attach some funny symbols. What numbers are missing? The bicoloured counters, counter boards and rings are very useful for covering and marking numbers. Turn them over and change red dots or rings into blue ones. They assist you to make calculations visible and to find solutions.

**Content:**

- 1 magnetic number line, 165 cm long
- 22 magnetic turn-over counters (Ø 5 cm)
- 22 magnetic turn-over rings (Ø 5.5 cm)
- 4 magnetic turn-over counter boards
- 10 magnetic symbols.

Comes with screws and dowels.

**87348V90**

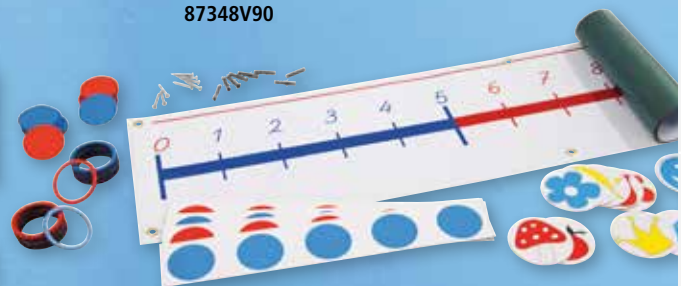
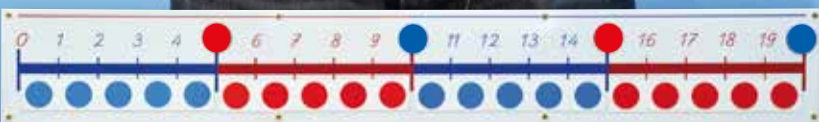

**Bead Strings**

Up to 20, every 5 beads a colour change

**20 Beads – Individual Bead, Ø 1.1 cm**

**85117V90** red/white



**85118V90** red/blue



**20 Beads – Demo Bead, Ø 2.3 cm**

**85119V90** red/white



**85120V90** red/blue



**Bead Strings**

Up to 100, every 10 beads a colour change

**100 Beads – Individual Bead, Ø 1.1 cm**

**85121V90** red/white



**85122V90** red/blue



**100 Beads – Demo Bead, Ø 2.3 cm**

**2014V90** red/white



**2015V90** red/blue



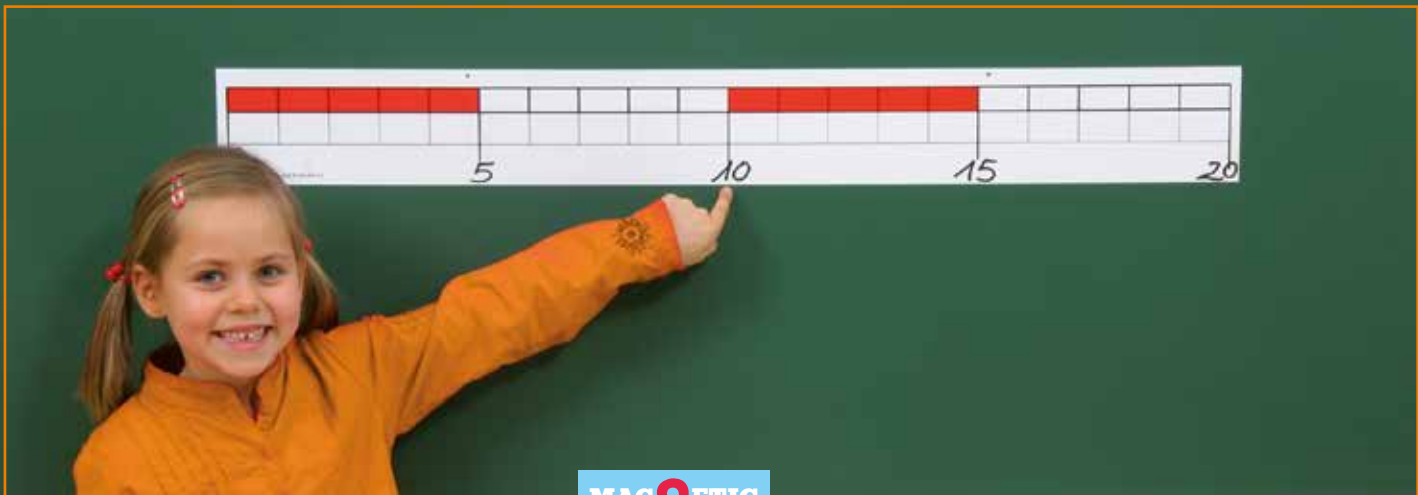

**MAGNETIC**

**BEST SELLER**



**Number Line to 20**

- › Wipeable surface suitable for water based markers
- › Magnetic – can be fixed securely onto any metallic surface
- › Overall length 100 x 11 cm wide
- › Made of thin rigid plastic
- › 20 sections – alternate 5 red & 5 white
- › To introduce numbers for demonstrating operations to 20
- › Marker enclosed

**85010V90**

**BEST SELLER**



**Small Counting Frame up to 20**

Dimensions (H x W x D): 6 x 23.3 x 2.9 cm, plastic beads, diameter: 11 mm, wooden frame.

**85034V90** 2 rows, red/blue



**85035V90** 2 rows, red/white



**Individual Counting Frame up to 20**

Wooden frame, triangular sides, very stable  
Length: 24 cm, plastic beads Ø 1.1 cm, wooden frame

**85036V90** 2 rows red/blue



**85037V90** 2 rows red/white



APPLICATION EXAMPLE:

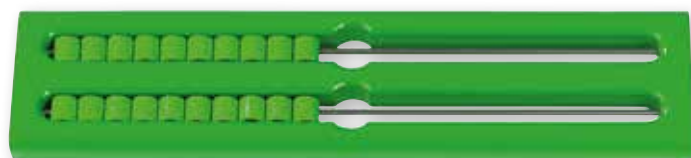

< NEUTRAL POSITIONING

COMPARE AMOUNTS >

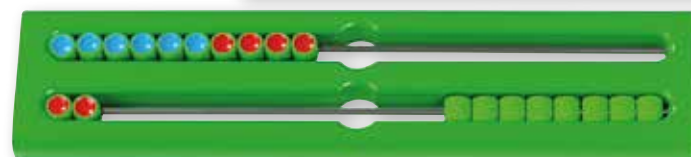
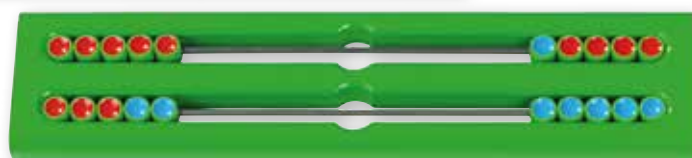

< NUMBER RANGE CROSSING

**Duplix 20**

A calculating device for numbers up to 20 that is not confined to colour groups of fives or tens. Children change the colours from blue to red or vice versa by spinning the elements or positioning them into neutral. Colour, amount and positioning of the calculating elements are defined only by didactic and methodical intentions. All elements can be shifted to the right or left. The rods are long enough, that the space in the middle is sufficient.

Dimensions (H x W x D): 6 x 27 x 2 cm

Made of stable plastic

**78102V90**

### Magnetic Hundred Board

Large 10 x 10 grid board on which 100 magnetic number tiles can be placed. The tiles are reversible; each has the same number front and back, in different colours, so that patterns can be easily displayed. Very versatile piece of equipment for class calculations.

#### Content:

board with grid (60 x 60 cm), aluminium frame with rounded angles, 100 bicoloured magnetic number tiles, 5 x 5 cm, in a sturdy box

85160V90



### Tray with 100 Magnetic Number Tiles

5 x 5 cm

89378V90



### Symbol Stamps

Children use the stamps for showing amounts or creating calculating riddles.

The stamps have the same illustrations as the magnetic counting symbols.

Set of 9 stamps, stamp size: 1.5 cm

Warning Notice: 1 (page 271)

88475V90 Set of 9



MAGNETIC

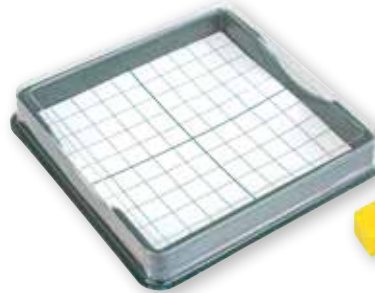

### Storage Box for 100 Units

This box can contain 100 units in cubes or in rods. Makes it easier to go from units to tens and from tens to hundred.

747V90 Empty box

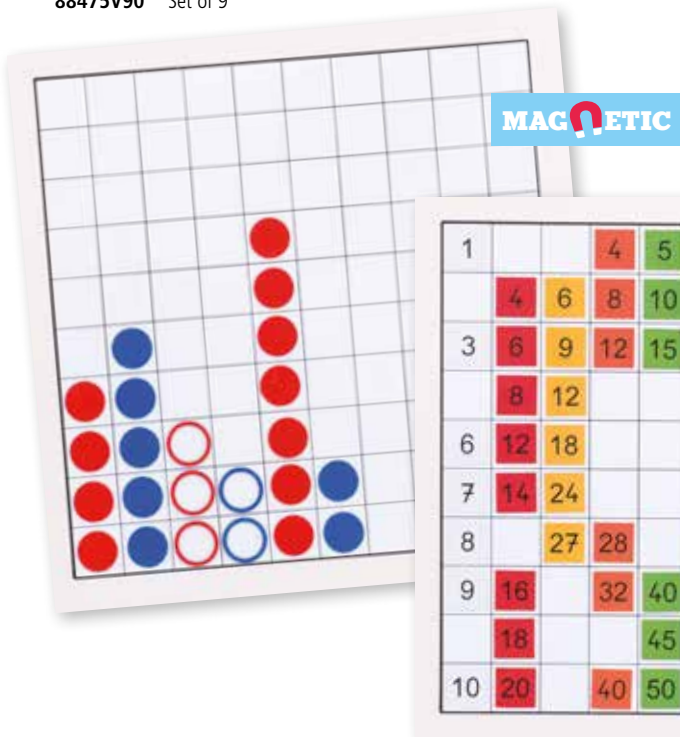
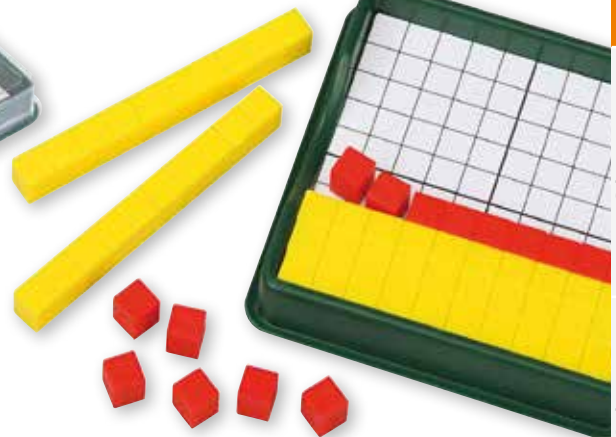

MAGNETIC

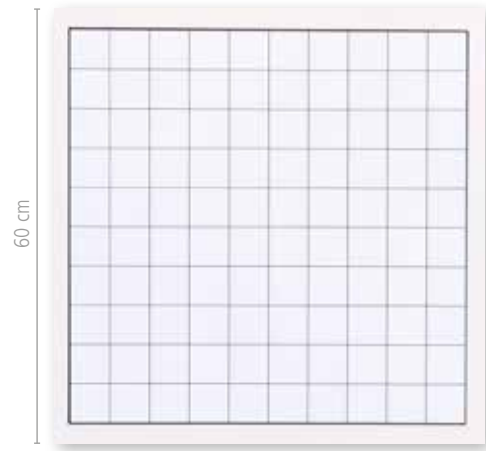

### Hundred Grid

Magnetic for white and blackboards. Can be used in many different ways.

Dimensions: 60 x 60 cm

Material: magnet foil

Comes without counters and number plates.

900641V90

**BEST  
SELLER**

**MAGNETIC**



38 MAGNETS

# MAGNETIC NUMBER LINE 0-100

With arithmetic arrows and magnets for marking, 3 m long  
 Make calculations visible and show the way how to find solutions. The arithmetic arrows are printed on both sides of magnetic bands. One side with red arrows for subtractions, the other side with black arrows for additions.  
 Use whiteboard markers to write directly on the number line.

- Content:**
- 1 magnetic number line
  - 3 metres long
  - 39 magnetic arrows printed on both sides
  - 38 magnets for marking (30 with Ø 2 cm, 8 with Ø 3 cm)

Screws and dowels included  
**86889V90**



39 MAGNETIC ARROWS

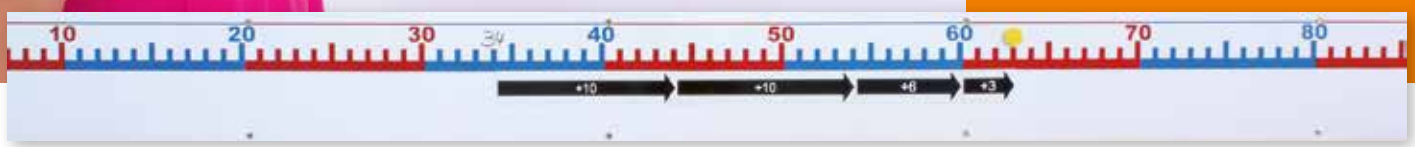

**MAGNETIC**

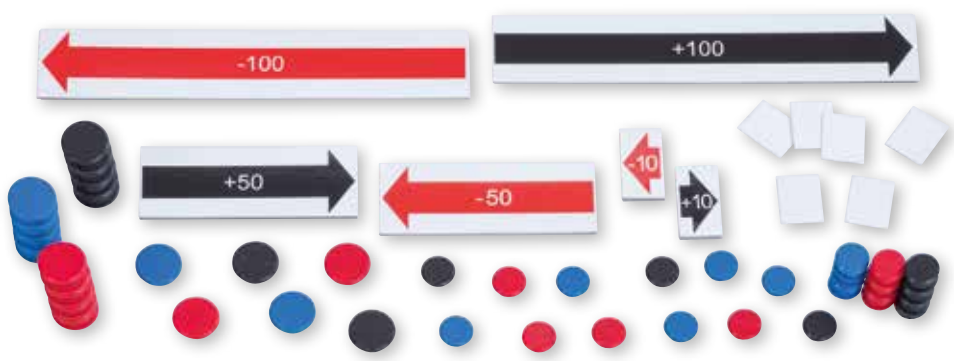

## Magnetic Number Line 0-1000

With arithmetic arrows, magnets and writeable tags for marking and orientation  
 Discover the number range up to thousand and make calculations and ways of solutions visible. The arithmetic arrows are printed on both sides of magnetic boards: One side with red arrows for subtractions, the other side with black arrows for additions. Use whiteboard marker to write on the tags or directly on the number line.  
 1 magnetic number line, 3 metres long, 30 magnetic arrows printed on both sides, 38 magnets for marking (30 with Ø 2 cm, 8 with Ø 3 cm), 8 magnetic tags for marking.  
 Comes with screws and dowels.  
**87370V90**





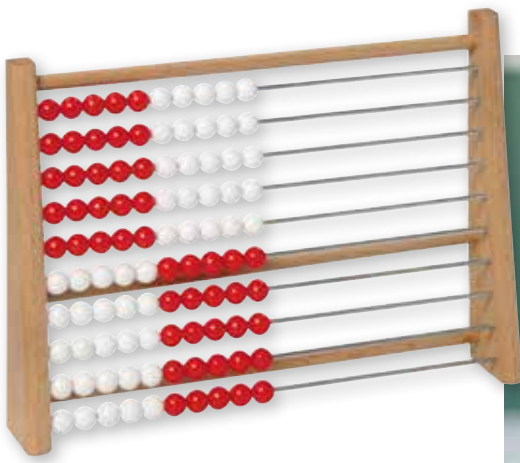

### Individual Counting Frame to 100

- › dimensions: 26 x 17 cm
- › plastic beads Ø 1.1 cm
- › beech-wooden frame
- › 10 bars from stainless steel
- › when the beads are moved from left to right, there is a free space in the middle

- 85144V90** 5 rows red/blue & 5 rows blue/red
- 85145V90** 5 rows red/white & 5 rows white/red
- 85105V90** 10 rows red/white



### "Count and See" – Counting Frame with 100 Cubes

Slide rule with number cubes up to 100. Cubes can be turned and shifted to rearrange the number sequence, the wooden rods are removable. Each cube has two red and two blue surfaces, a number is printed on one side, the other side is blank. Ideal for demonstrating number patterns, partitioning numbers, addition and subtraction tasks and practicing different mathematical concepts. The frame is wide enough, that plenty of space is left in the middle when the cubes are shifted to the left or right. The counting frame can be stationed on a table or fixed to a blackboard (cant hooks included). Dimensions (W x H): 87 x 77 cm, solid wooden frame

**5449V90**

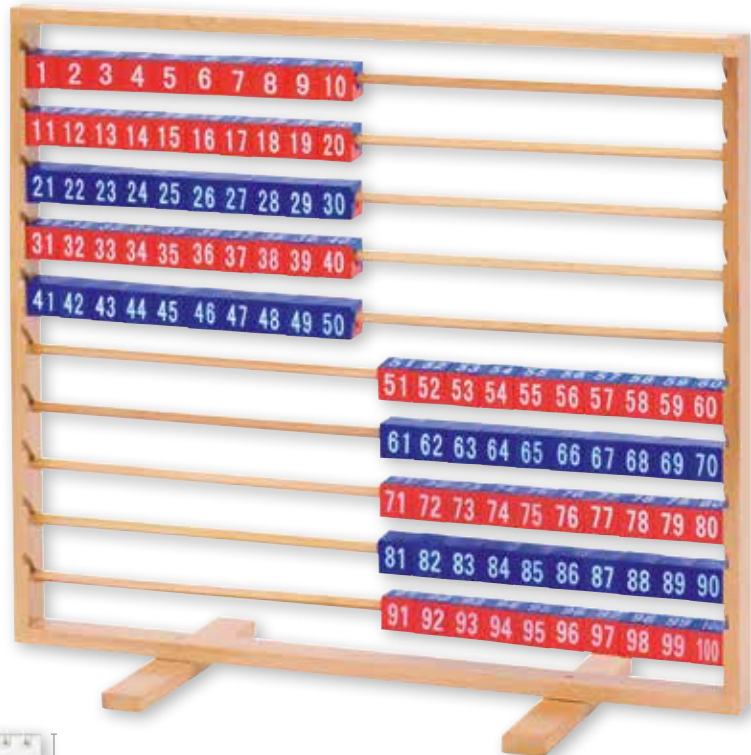

### Flip Book

With these flip books children can show the result of their calculations. The register helps the children to find the numbers more quickly. The cards are sturdy and laminated.

Dimensions (W x H): 22 x 13 cm

**9876V90**

### Hundred Board with Hundred Grids

Set of 5 boards  
1 x with numbers  
4 x grid only

**760461V90**

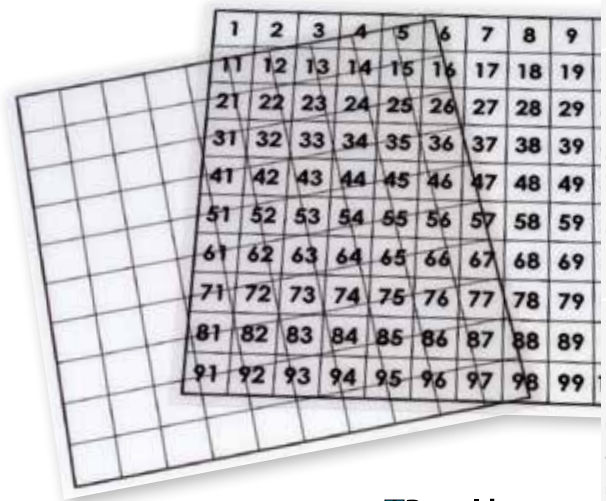

Minimum order: € 400,-



**MAGNETIC**



**Number Board up to 100, with marking signs**

This board shows the space up to 100 at a glance. Mark several numbers with magnetic rings, or cover them with magnetic dots to show various mathematic principles in structures, orders and relations. Discover geometric patterns, find previous and following numbers or conduct calculations in an amusing way.

**Content:**  
board with numbers (60 x 60 cm), aluminium frame with rounded angles, 20 bicoloured magnetic rings, 20 bicoloured magnetic counters

- 86145V90**
- 81930V90** Set of 20 Bicoloured Magnetic Rings
- 86234V90** Set of 20 Bicoloured Magnetic Counters

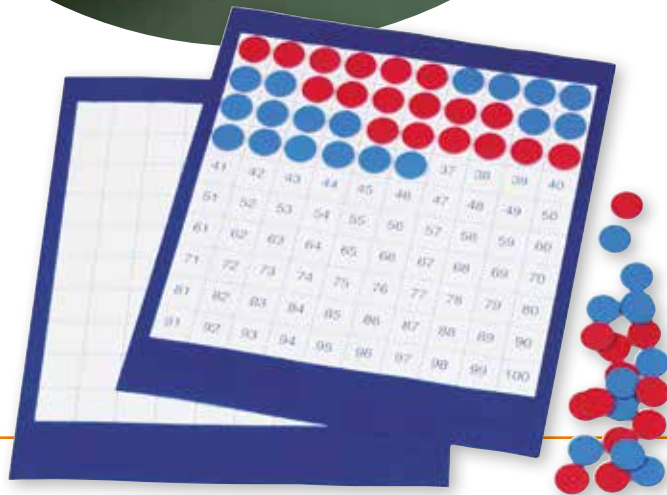

**Hundred Board**

Dimensions: 31 x 33 cm, printed on both sides.  
On one side: 1–100 square  
On the other side: blank grid  
Wipeable surface suitable for water based markers. Can be used with transparent counters or with bicoloured counters (see above).

**8424V90**



**Rod Track**

100 cm ruler with 1-cm-channels for 1 cm cubes or cuisenaire rods. It is very useful in number recognition, counting and math activities. The ruler has one channel on one side and two on the other. Cubes are not included

**756606V90**

**Cuisenaire Rods**

Colourful wooden blocks ranging from 1 cm to 10 cm lengths. They're great for creating patterns, counting, sorting, measuring, adding, multiplying, and all sorts of other fun explorations. Also very useful in combination with the Rod Track (see above)

**Cuisenaire Rods, small set**

**Content:** 74 pieces  
Warning Notice: 1 (page 271)  
**85823V90** In polybag

**Cuisenaire Rods, large set**

**Content:** 300 pieces  
Warning Notice: 1 (page 271)  
**756641V90** In wooden box with transparent lid



# WALL NUMBER LINES

These large wall number lines are printed in one piece and are made of thin rigid plastic. Pegs and hooks are included.  
10 red and 10 blue pegs to indicate numbers included.

## Number Line 0–20

2 metres long  
7783V90



## Number Line 0–100

3 metres long  
7784V90

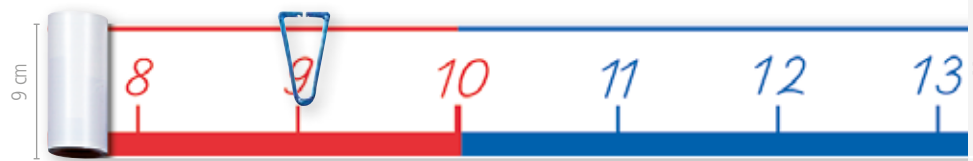

## Number Line 0–1000

5 metres long  
7861V90



## Number Line 0–10 000

10 metres long  
7862V90



## Number Line 0–100 000

5 metres long  
7882V90

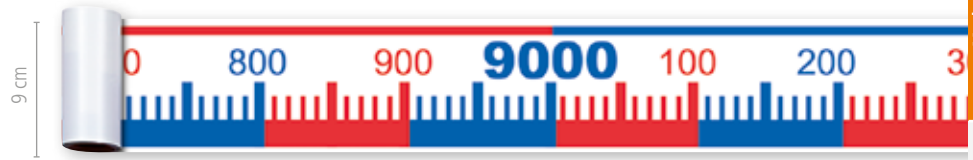

## Student Number Lines

Made of thin rigid plastic. Same printing as the wall number lines. 10 red and 10 blue pegs included.

### Number Line 0–100, 1 metre long

81902V90 In storage tub

### Number Line 0–1000, 1 metre long

81903V90 In storage tub

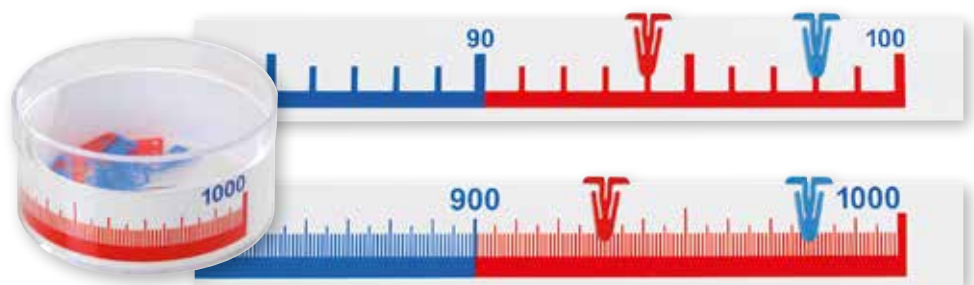

**MAGNETIC**

## Number Line to 100

- › Wipeable surface suitable for water based markers
- › Magnetic – can be fixed securely onto any metallic surface
- › Overall length 200 cm x 11 cm wide
- › Made of thin rigid plastic – 2 pieces
- › 100 sections – alternate 10 red & 10 white
- › Marker enclosed

85019V90

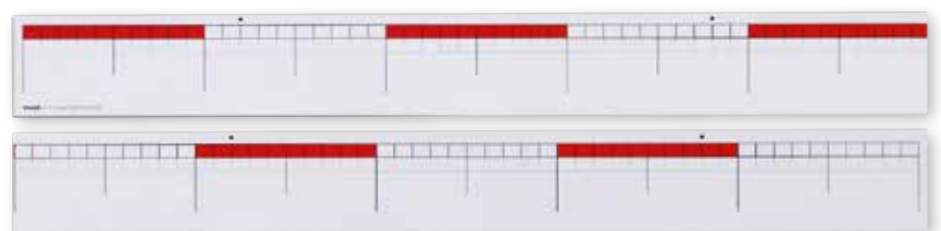



MACNETIC



**Magnetic Number Cards 1–9000**

Large cards in 4 colours with the numbers 1 to 9000. The numbers 1 to 9 are written in red, the numbers 10 to 90 in yellow, 100 to 900 in green and 1000 to 9000 in blue. You can use these cards to “build” any number ranging from 1 to 9999. (The colours of this set are the same as the colours of 85381V90, 86528V90, 85150V90, 81940V90)

- 86997V90** Without tray
- 87937V90** In tray

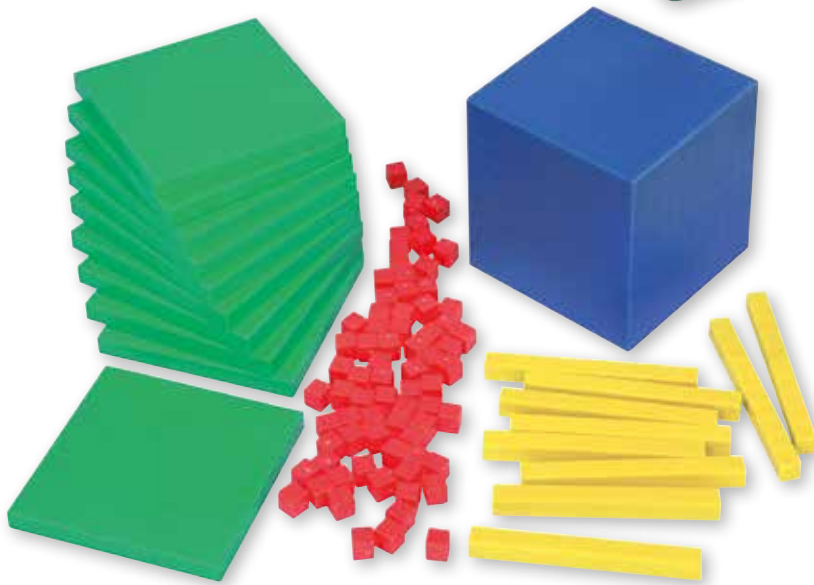

**Plastic Base, Set of 10**

Teach numerical value, place value, equivalent value, and rounding.

The set includes: 100 cubes, 10 rods, 10 flats, 1 cube

The colours of the set are the same as the colours of the magnetic base, Set of 10  
Warning Notice: 1 (page 271)

**81940V90**

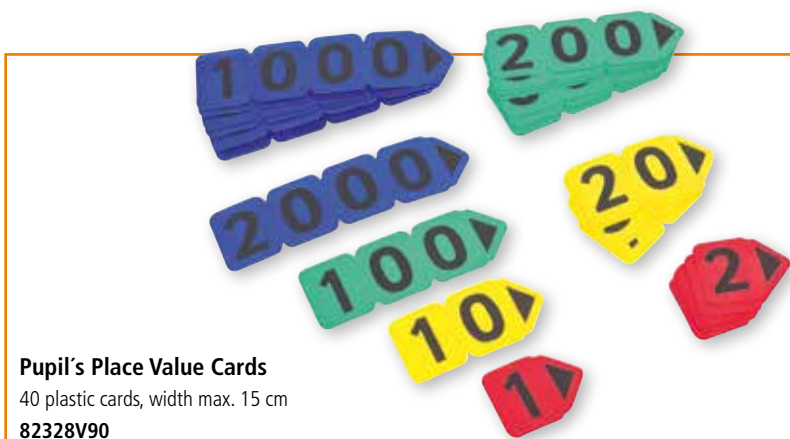

**Pupil's Place Value Cards**

40 plastic cards, width max. 15 cm  
**82328V90**



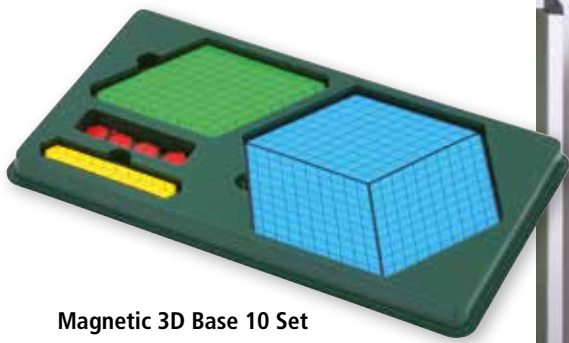

### Magnetic 3D Base 10 Set

To easily understand the decimal system. This demonstration set offers the possibility to work with the whole class. Produced in a 3-dimensional way and in different colours.

**Content:**

- 25 units
- 12 tens (10 + 2 extra)
- 12 hundreds (10 + 2 extra)
- 5 thousands

- 85381V90** Without tray
- 87992V90** In tray

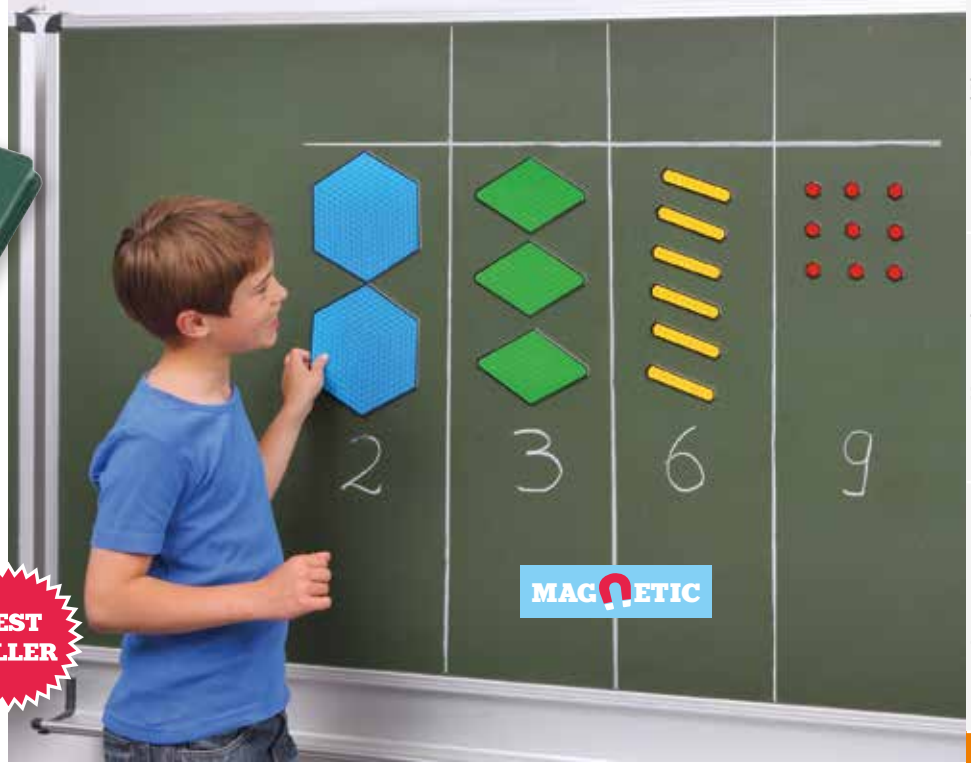

### Base 10 Class Set

To obtain a greater understanding of our number system while adding and subtracting. The relation between units, tens, hundreds and thousands will be easily understood. The colours of this set are the same as the colours of the magnetic 3-D base 10 set (see above). This way the children go from very concrete material to more abstract.

**Content:**

- 100 red units, 50 yellow tens, 30 green hundreds, 4 blue thousands

Warning Notice: 1 (page 271)

**86528V90**

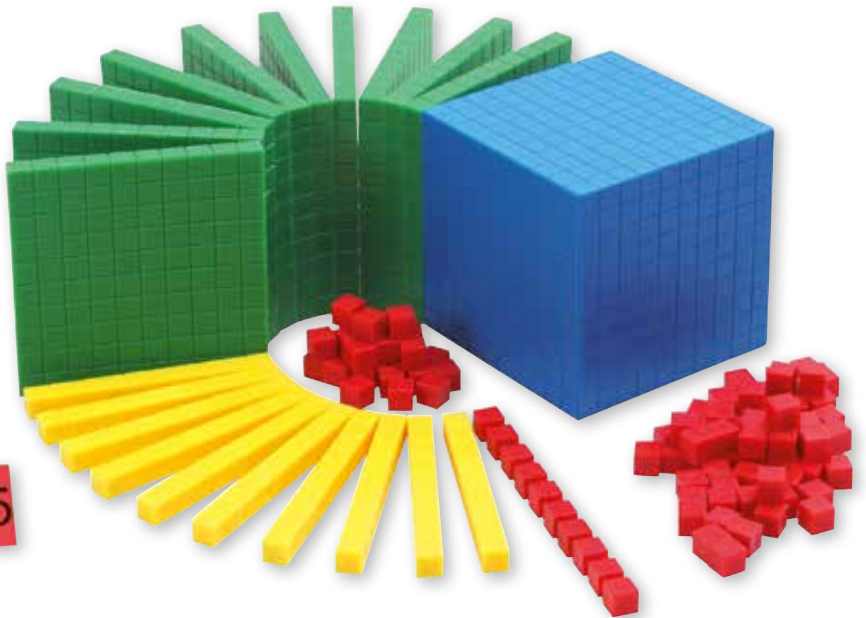

### Pupil's Place Value Cards

40 cards, made of sturdy carton, width up to 9 cm  
**87646V90**

### Magnetic Place Value Sheet

An understandable way to see how the decade system works. Place the marking frames and give a sight of numbers and their digits. The colours of the 4 rows are in line with our range of Base 10 materials.

**Content:**

- 1 magnetic place value sheet (63 x 28 cm)
- 8 marking frames

**87293V90**

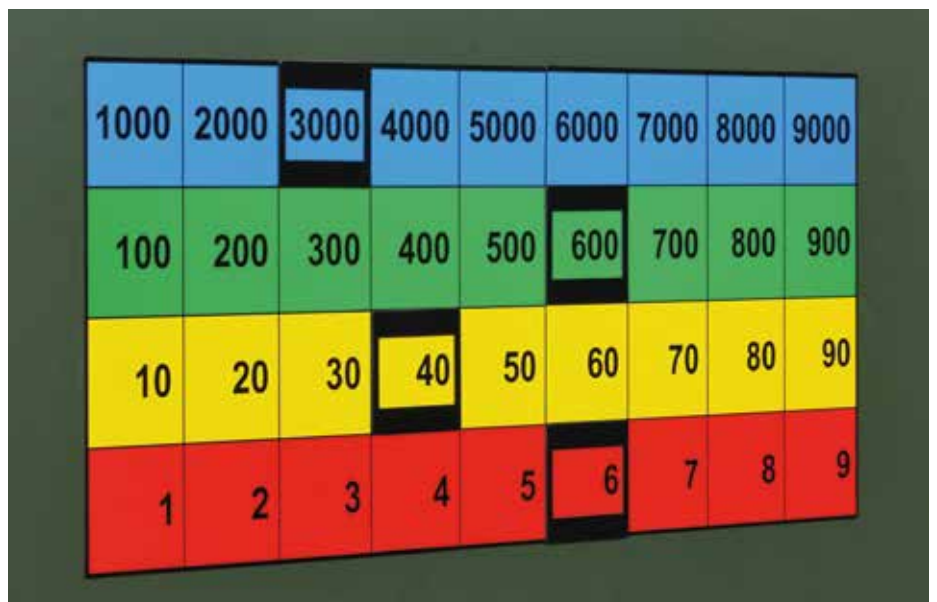

# DECIMAL FLIPS



## Place Value Dice

2 sets of 4 ten-sided jumbo dice for place value activities and games. The red dice indicates units, the yellow is for tens, the green is for hundreds and the blue is for the thousands. Same colour-coding as the sets above.

Warning Notice: 1 (page 271)

**85150V90** Set of 8 dice

## Place Value Dice up to 9 Million

Set of 6 ten-sided jumbo dice: 2 for 10,000, 2 for 100,000 and 2 for 1,000,000  
Warning Notice: 1 (page 271)

**87732V90**

## Decimal Flips

Students get an insight in the decadic system and the correct diction of numbers in the value system with the Betzold Decimal-Flip. The field of application is huge: the children can solve exercises of addition, subtraction or multiplication, control their written exercises or present their computing result.

The flip cards are printed with the numbers 0–9 for each value. Therefore, each value has an own colour. There are multiple possibilities of exercises and playing using the coloured value dice and the flip. The flip is made from stable carton and can be interfolded and packed into the schoolbag.

### Decimal Flip Student

Dimensions (W x H): 18 x 9 cm

**756589V90**

### Decimal Flip Teacher

Dimensions (W x H): 35 x 19.5 cm

**756590V90**

## Interlocking Base 10

- › These separate elements show very clearly how they relate to each other and how the relation is between a unit and a ten ...
- › Each element has a decimal mark.
- › Interlocking elements enable children to make tens using units, hundreds using tens ...

### Content:

- 100 cubes (1 cm<sup>3</sup>) (units)
  - 10 rods (tens)
  - 10 flats (hundreds)
  - 1 cube (1 dm<sup>3</sup>) (thousand)
- All Warning Notice: 1 (page 271)

**1424V90** In plastic bag

**2977V90** Set in a plastic box with lid

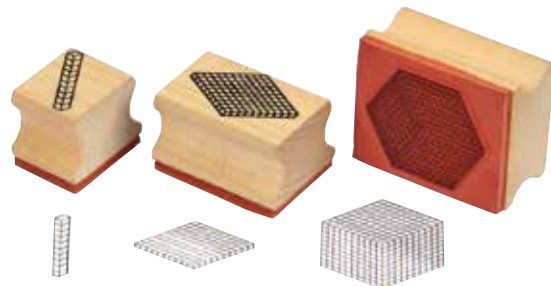

## Base 10 Stamps

Content: 4 stamps  
Dimensions: 3.5 x 3.8 x 2 cm (cube-stamp)  
Warning Notice: 1 (page 271)

**86919V90**



## Demonstration Board

To demonstrate different counting operations very clearly.

Principles of the decimal system are visualised. Surface can be written on with dry-erase markers. Printed on plastic.

### Version 1: Black and White with Symbols

Dimensions (W x H): 58 x 40 cm

**85066V90**

### Version 2: Four Colours with Numbers

Dimensions (W x H): 48 x 33 cm

**89884V90**

As long as available

**Wooden Base 10**

Made from beech wood  
100 units, 10 tens, 10 hundreds, 1 thousand  
In plastic storage box  
Warning Notice: 1 (page 271)

**761735V90****Wooden Base 10 Elements**

Made from beech wood

**761730V90** Units: bag with 1000 cubes

Warning Notice: 1 (page 271)

**761732V90** Tens: bag with 100 longs**761731V90** Hundreds: bag with 10 flats**761733V90** Thousand: 1 cube 1 dm<sup>3</sup>**Wooden Base 10**

100 units, 10 tens, 10 hundreds, 1 thousand  
In plastic storage box  
Warning Notice: 1 (page 271)

**2998V90**

As long as available

**Wooden Base 10 Elements****1553V90** Units: bag with 1000 cubes

Warning Notice: 1 (page 271)

**1554V90** Tens: bag with 100 longs**95086V90** Hundreds: bag with 10 flats**95087V90** Thousand: 1 cube 1 dm<sup>3</sup>

As long as available

**Counting Cards**

A number is presented in 5 different ways. Try to find the 5 representations. If you have found them, turn around the 5 cards and check if all the cards display the same sign. Each set consists of 28 exercises (140 cards), stored in a 'Learn-Box'.

**86616V90** Counting Cards to 100**86621V90** Counting Cards to 1,000

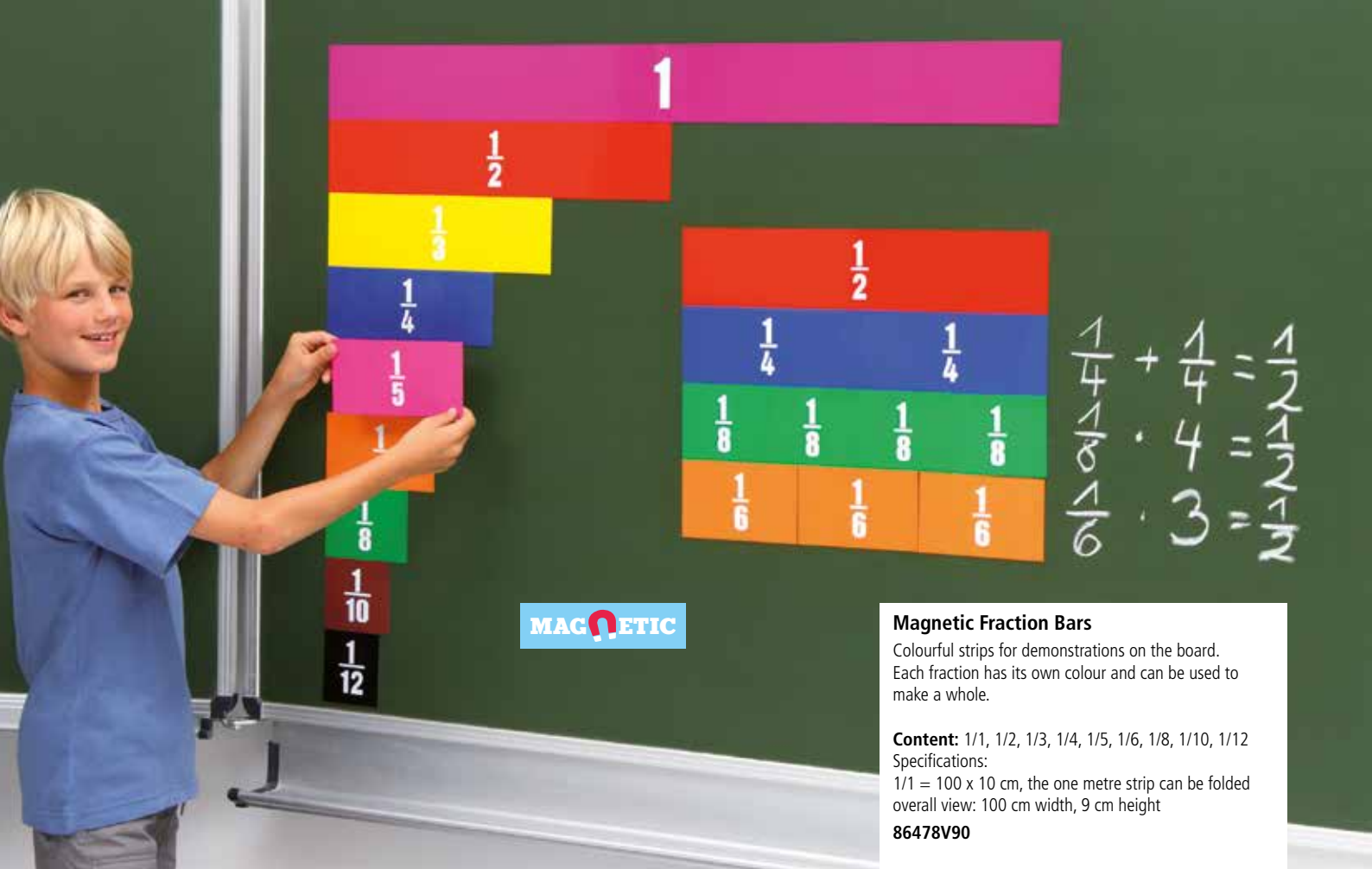

MAGNETIC

### Magnetic Fraction Bars

Colourful strips for demonstrations on the board. Each fraction has its own colour and can be used to make a whole.

**Content:** 1/1, 1/2, 1/3, 1/4, 1/5, 1/6, 1/8, 1/10, 1/12  
**Specifications:**  
 1/1 = 100 x 10 cm, the one metre strip can be folded  
 overall view: 100 cm width, 9 cm height  
**86478V90**

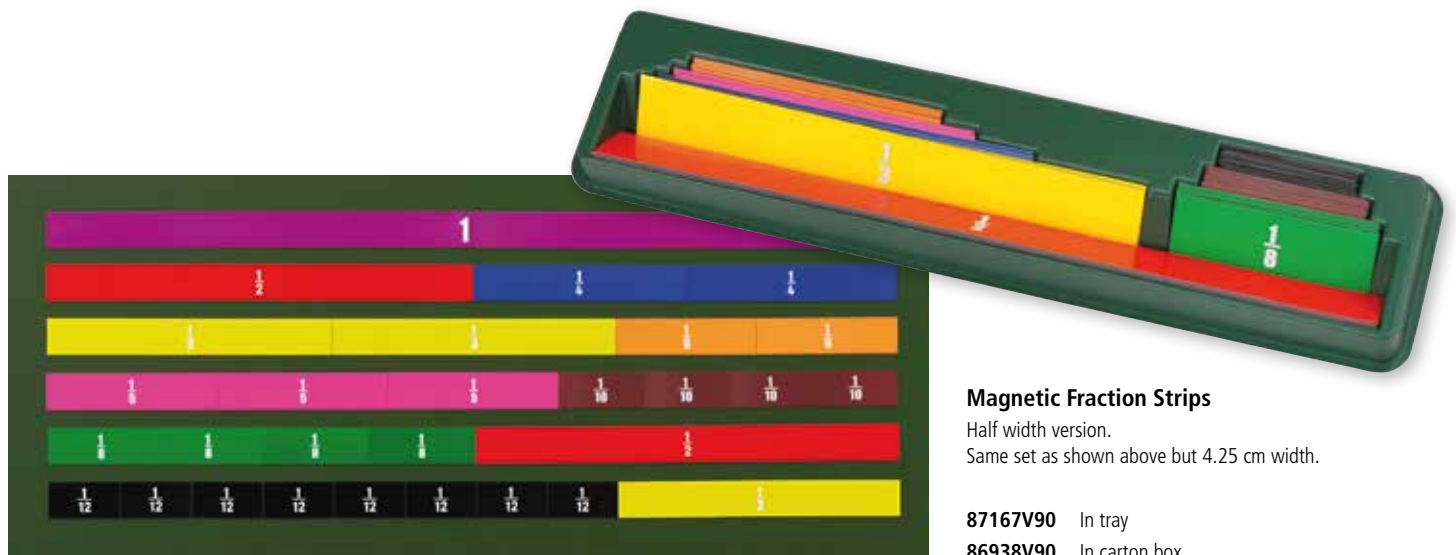

### Magnetic Fraction Strips

Half width version. Same set as shown above but 4.25 cm width.

**87167V90** In tray  
**86938V90** In carton box

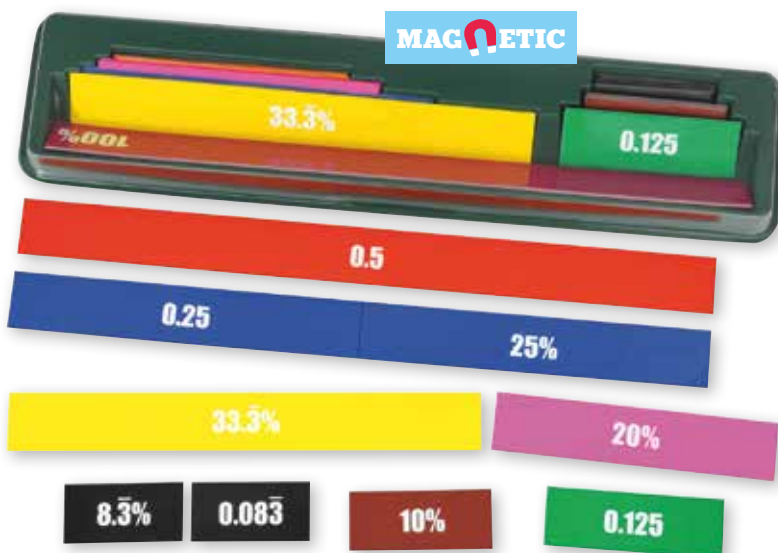

### Magnetic Decimal and Percentage Strips

The strips are printed on both sides. They show decimals on one side and percentage equivalents on the other. Size: 1/1 = 100 x 4.25 cm

**87510V90** In tray  
**87300V90** In carton box



**BEST  
SELLER**



**MAGNETIC**

**Magnetic Fraction Circles**

The set includes 9 circles divided into 1/2, 1/3, 1/4, 1/5, 1/6, 1/8, 1/10, 1/12 and 1/1 in a sturdy sorting tray. diameter 1/1: 20 cm

**86897V90** In sorting tray

**86623V90** Sorting tray (empty)



**Round Fraction Set**

51 pieces

A practical way of understanding fractions. Ideal material to work independently. Easy to manipulate.

A set contains 1/1, 1/2, 1/3, 1/4, 1/5, 1/6, 1/8, 1/10, 1/12.

Pieces are 3 mm thick. The fraction is impressed in the plastic. Each circle measures 10 cm.

**85522V90** In plastic box with lid



**FRACTIONS, PERCENTAGES  
AND DECIMALS**

**MAGNETIC**

**Magnetic Decimal and Percentage Circles**

The circles are printed on both sides. They show decimals on the one side and percentage equivalents on the other. Size: 1/1 = 20 cm

**87511V90** In tray

**87301V90** In carton box

Minimum order: € 400,-



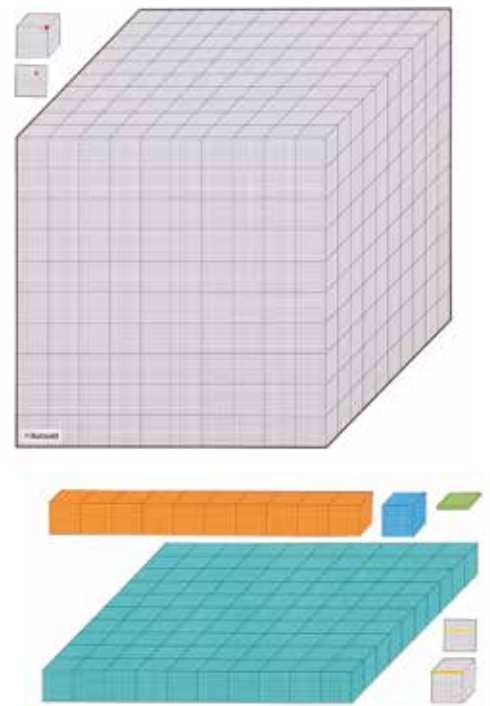

### Demonstration Set – One Million

This demonstration set “One Million” visualises the number with the 6 zeros. The students will easily comprehend the quantity as the one million single cubes are structured and divided into thousands, ten thousands, hundred thousands and one million. These steps of structuring can be made visible due to the new magnetic black board material.

#### Content:

1 cube of one, 1 bar of ten, 1 cube of hundred, 1 cube of one thousand, 1 bar of ten thousand, 1 bar of one hundred thousand, 1 cube of one million

**757610V90**

### Decimal Flip Millions

Students are able to represent numbers in the sector one million with the Betzold Decimal-Flip One Million. Cards are printed with the number of 0–9 for each value – each position has a different colour. The flip offers many exercise- and playing possibilities in connection with the coloured value dice.

Dimensions (W x H): 32.5 x 9 cm

**756588V90**



### Decimal Flip

Displays hundred thousands, ten thousands, thousands, hundreds, tens and units. Handy colour coding.

Dimensions (H x W x D): 9 x 26.5 x 6.5 cm

**755530V90**



### Pupil's Fraction Strips

Colours, fractions and quantity of the strips are the same as the magnetic demonstration version (86478V90). Pupils can work effectively with this material. Due to the frame a shifting of the single parts is impossible.

#### Content:

1/1, 1/2, 1/3, 1/4, 1/5, 1/6, 1/8, 1/10, 1/12  
Frame size: 24 x 24 cm

86438V90

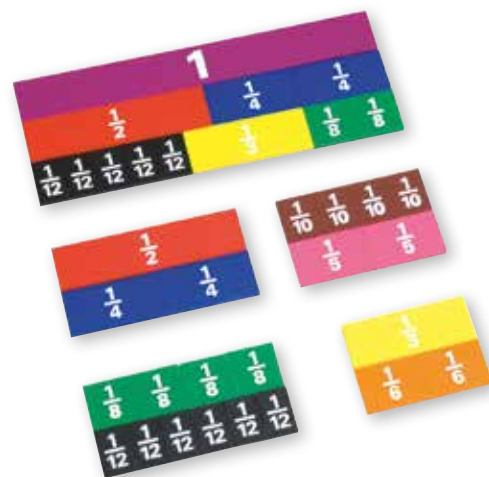

### Fractions and Geometry Set

#### Content:

- › 1 board (20.5 x 20.5 cm)
- › fraction segments (1, 1/2, 1/3, 1/4, 1/5, 1/6, 1/8, 1/10, 1/12, 1/24)
- › 2 packs of rubber bands

One side of the base board has a circular recess (Ø 10 cm) to put in the fraction segments and pins for the rubber bands. The fractions and the degrees are printed on the board. The reverse of the board has 121 pins (11 x 11) for geometrical use.

Warning Notice: 1 (page 271)

85530V90 Set

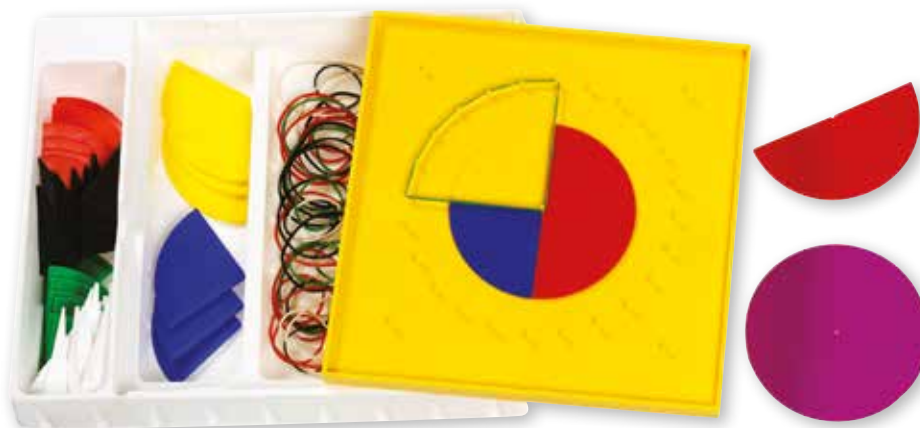

### Fractions-Flip

The Betzold Fractions-Flip is the perfect demonstration material for fundamental terms and functions of fractions. The exercises can be varied and adapted to the level of performance.

Dimensions (H x W x D): 9 x 26.5 x 6.5

756741V90



### Round Fraction Stamps

Stamp them, paint them and learn how fractions are related to the unit. An appealing way of understanding fractions.

Warning Notice: 1 (page 271)

87595V90 Set of 9 stamps, Ø 2.5 cm



# MAGNETIC COORDINATE SYSTEM

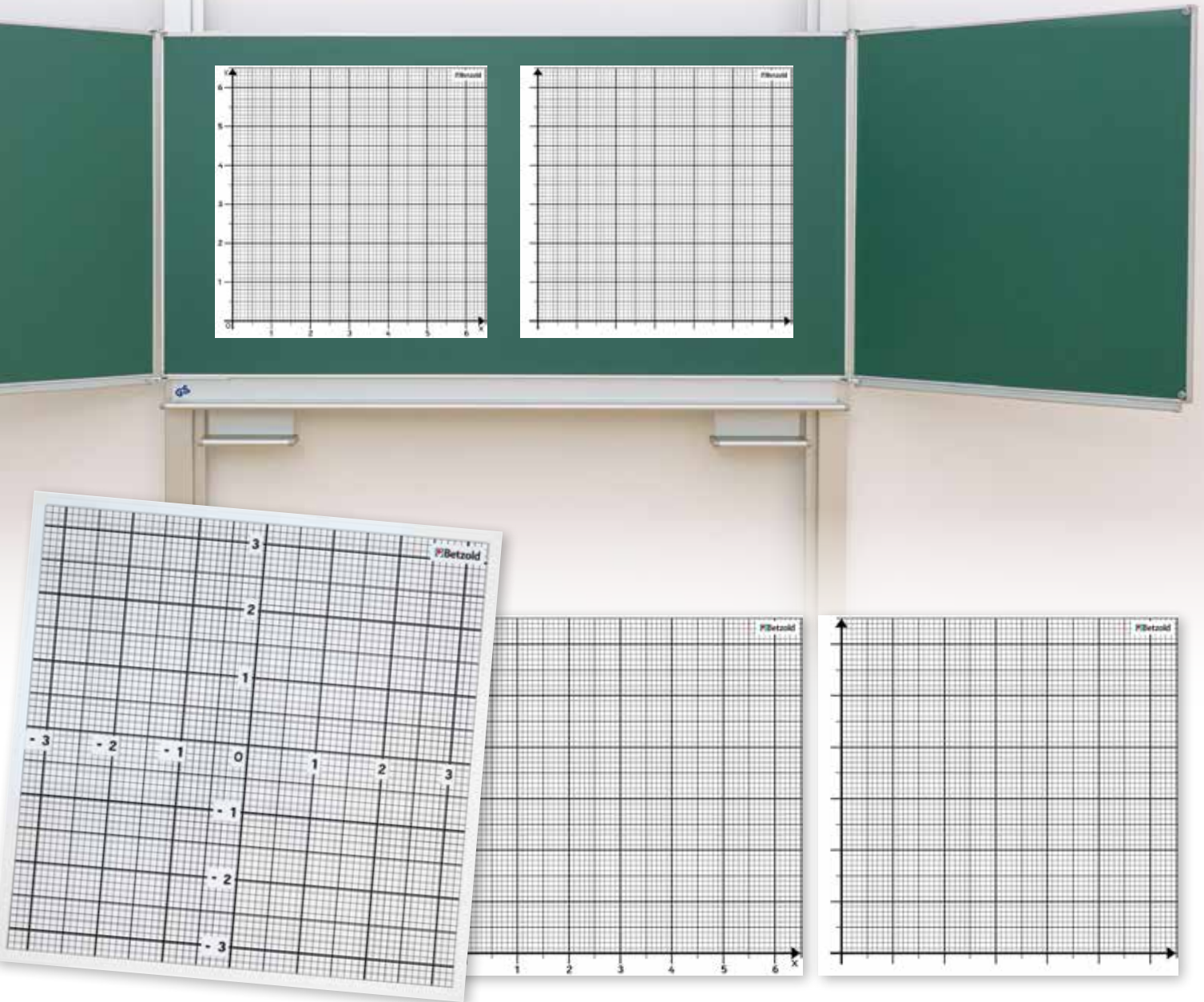

## Magnetic Coordinate System, definable

This magnetic coordinate system offers enough space for individual designing. The pattern measures 65 x 65 cm. Steps of 5 cm and 10 cm are marked by thicker lines. However, there is no x- and y-axis given. Instead, the set includes magnetic cards with numbers which can be fixed on the imagined axis.

The magnetic mat can be inscribed with whiteboard-markers due to its surface-covering.

The best advantage: a ruler is no longer needed to mark the dots, because the pattern is generated in steps of 1 cm.

Dimensions: 70 x 70 cm

### Content:

- > 1 magnetic coordinate system
- > cards with numbers from 0 to 9
- > "-" presentation cards

**757812V90**

**757635V90** Magnetic Coordination System, marked

**757637V90** Magnetic Coordination System, blank



## Whiteboard Marker

The Whiteboard Marker is available in a set with 4 colours: Red, blue, black, green.

- > round tip, Ø 1.5 cm
- > dry wipeable
- > suitable for all whiteboards and flipcharts

**754794V90**



2 METRES LONG WITH NEGATIVE AND POSITIVE FIGURES.



**Number Line from -10 to +10**

Visualises the negative number range from -10 up to the positive range of +10.

88365V90



**Roman Numbers**

Getting to know the Roman symbols for numbers. The front shows a number written in Roman symbols. The back side shows the number in Arabic.

There are 3 sets. Each set consists of 20 cards – printed recto verso. Each set comes in a box.

87964V90 Set 1: Numbers from 1 to 20

87965V90 Set 2: Numbers from 21 to 100

87966V90 Set 3: Numbers from 100 to 2100

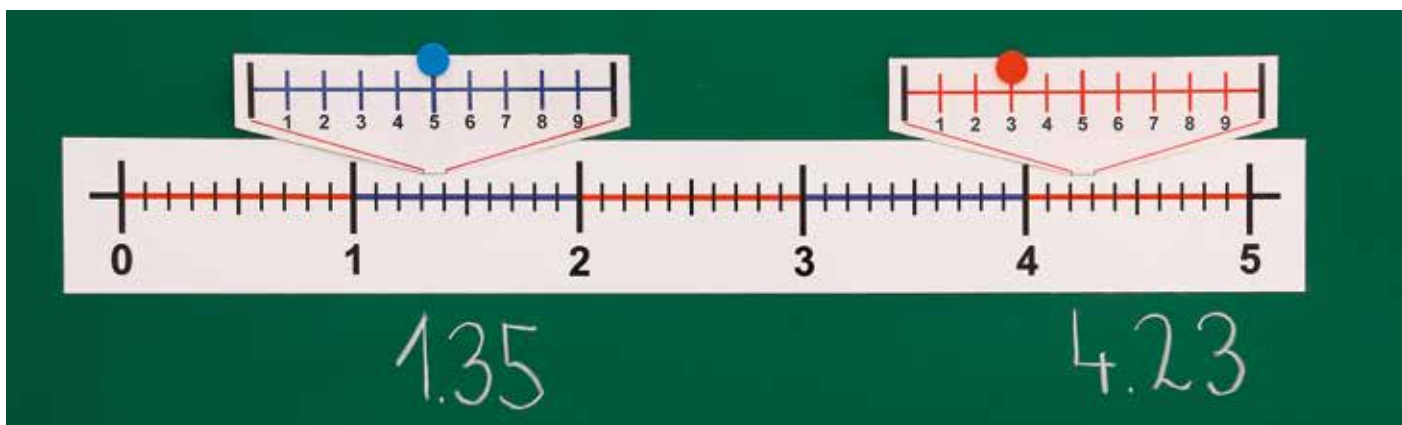

**Decimal Number Line with Decimal Expander**

Demonstrates the decimal numeration and makes it easy to understand how it works. Between the whole numbers there are decimal marks. They divide the distance between 2 whole numbers in ten parts. You can name each decimal mark exactly. For example: The 6th mark after the integer 2 is called 2.6.

But what about the space between decimal marks? Use the first decimal expander and show plausibly that the

space between 2 decimal marks can also be divided in 10 parts. For example: The 6th mark between 2.6 and 2.7 is called 2.66 (as shown in the picture).

If you want to go one step further, you can explain with the help of the 2nd decimal expander that the space between 2.66 and 2.67 can also be divided in the parts: to show this simply put the 2nd extender above the first one. Length: 1.3 m

88371V90





# MULTIFUNCTIONAL BALANCE

## With 2 Transparent Buckets

A balance especially developed for primary schools to give a wide and varied experience in weighing. Very stable and very fine balancing.

2 transparent buckets with lids. Each bucket will hold up to 1 litre. The children can read the volume of liquids and small parts on the scales of the bucket. Each bucket has a lid. These lids can become pans to use with small objects or to hold the weights.

In the balance 2 selections of weights are stored. (1 in the front side and 1 in the back side).

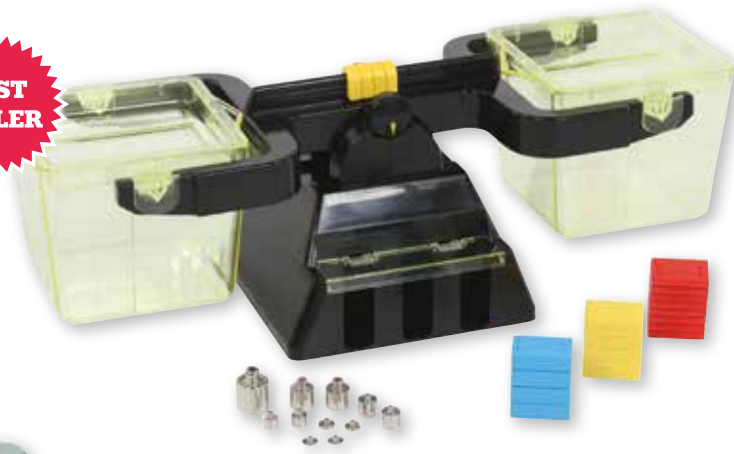

11 metal weights:  
2x 1 g, 2x 2 g, 2x 5 g, 2x 10 g, 2x 20 g, 1x 50 g

14 plastic weights:  
8x 5 g, 4x 10 g, 2x 20 g

Children can weigh a lot of objects up to 1 gram in the classroom, (e. g. pens, scissors ...)  
A good comparison can be made between volume and weight.

Warning Notice: 1 (page 271)

**2205V90**



## Extra Set Weights with White Printings

So children can weigh bigger objects and liquids. They can weigh up to 2 kg. Following weights are included:  
1x 500 g, 2x 200 g, 1x 100 g

**2206V90**



## Metal Weights

Set of 11 weights with imprinting  
2x 1 g, 2x 2 g, 2x 5 g, 2x 10 g, 2x 20 g, 1x 50 g  
**86717V90**



## Plastic Weights

Set of 76 stackable weights in plastic box with lid.  
**Content:** 20x 1 g, 20x 5 g, 20x 10 g, 16x 20 g  
Warning Notice: 1 (page 271)

**86716V90**

# IDEAL FOR CLASSROOM USE!



## School Balance, metal

Very sturdy metal balance. Ideal for classroom use. To introduce pupils to the concepts of balancing. To compare masses of many interesting materials. Children find out exactly what happens when a weight is taken away. Comes without weights

**85269V90** Capacity 2 kg (17 x 40 x 14 cm)

**85270V90** Capacity 5 kg (20 x 49 x 16 cm)



# WEIGHT SETS

in wooden boxes

Weight Sets	Brass weights						Iron weights with white printings				
	1 g	2 g	5 g	10 g	20 g	50 g	100 g	200 g	500 g	1 kg	2 kg
<b>A</b> without lid 1056V90	1	2	1	2	1	1	2	1	1	1	-
<b>C</b> with lid 1058V90	1	2	1	2	1	1	2	1	1	1	-
<b>D</b> with lid 1059V90	1	2	1	2	1	1	2	1	1	2	1



### Pan Balance

Measuring and comparing weights can be fun. Little chefs can use this colourful balance in the play kitchen to weigh ingredients. They playfully learn to compare the mass of a liquid with a specific volume to other objects. Grasping the concept of measurement has never been easier.

Dimensions: Balance (W x H): 36 x 28 cm  
 Pans: Height: ca. 7 cm, diameter: 18 cm  
 Warning Notice: 1 (page 271)

**57238V90**



### Weight Set Brass, 10 Pieces

**Content:**  
 2x 1 g, 2x 2 g, 2x 5 g, 2x 10 g, 1x 20 g, 1x 50 g  
 Total combined weight is 106 g.

**85752V90** In storage box with lid



### Suspension Balance

With metal body  
 Diameter: 15 cm  
 Capacity: 25 kg  
 Comes with suspension ring and load hook

**86070V90**



### Digital Kitchen Scale

This all purpose scale has a 5000 g capacity.  
 Accuracy of 1 g.  
 Dimensions: Platform: diameter: ca. 13 cm  
 Bowl: diameter: ca. 20 cm

**86111V90**

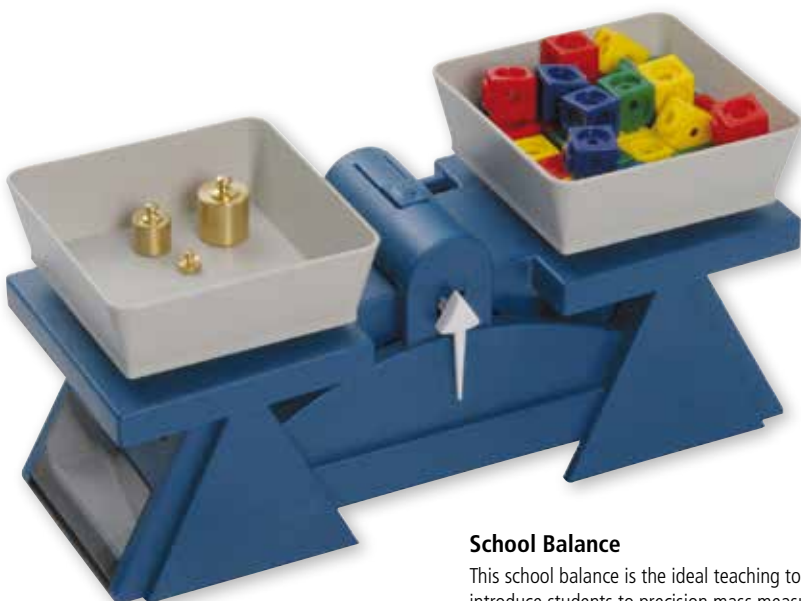

### School Balance

This school balance is the ideal teaching tool to introduce students to precision mass measurement. With a capacity of 2000 g a variety of readily available objects such as paper clips, coins, books and more can be measured. The interchangeable pans are easily removable for pouring, cleaning and storing.

Dimensions (H x W x D): 13.5 x 29 x 10.5 cm

**85751V90**



### Spring Scales

Spring scales can be used for force and mass measurements. Each scale is calibrated in Newtons and grams.

**764V90** 0–250 g

**765V90** 0–500 g

**766V90** 0–1000 g

**767V90** 0–2000 g

**768V90** 0–3000 g

**769V90** 0–5000 g





### Litre Cube

This cubic decimetre box contains exactly one litre. It demonstrates the relationship between linear, volume and mass. Calibrated in 100 ml intervals. Lid is included.

**87567V90**



### Measuring Beakers

5 beakers: 1000 ml, 500 ml, 300 ml, 200 ml, 100 ml. Calibrated with a clearly marked scale. Made of plastic.

**85044V90**



### Measuring Cylinders

7 cylinders: 1000 ml, 500 ml, 250 ml, 200 ml, 100 ml, 50 ml, 25 ml. Calibrated with a marked scale. Made of plastic.

**85439V90**

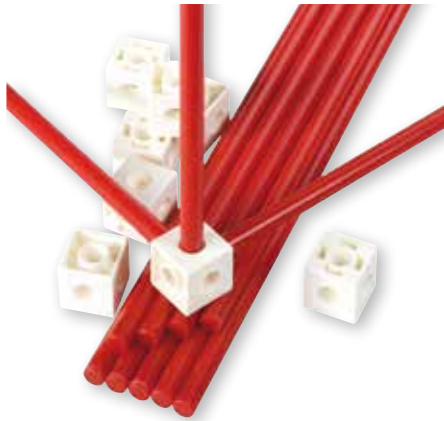

### Cubic Metre

To demonstrate 1 cubic metre. Consists of 12 rods of 100 cm and 8 connectors.

**85511V90**

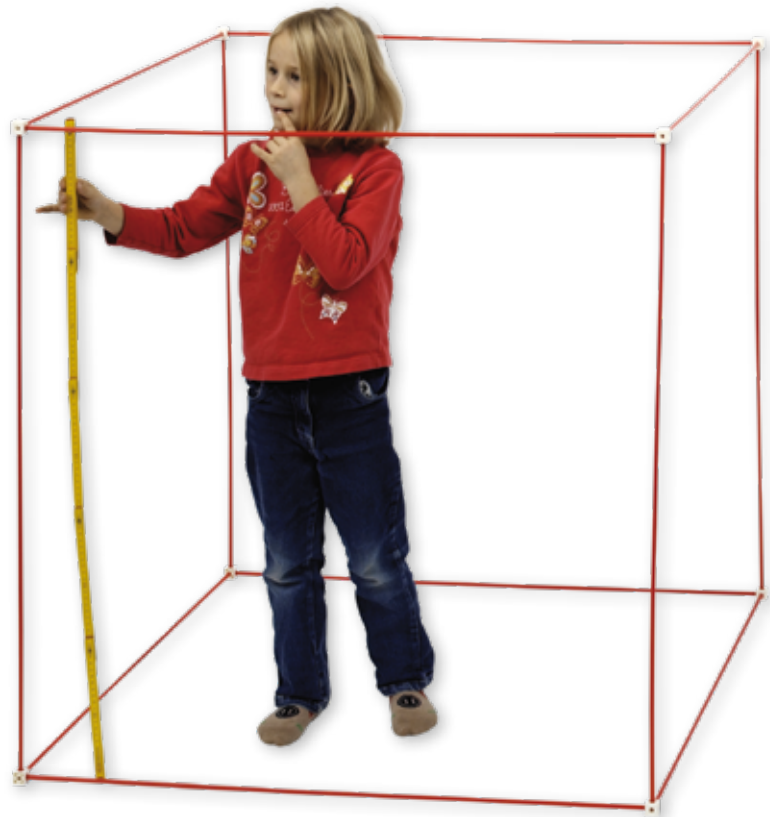

### Windup Metre Tapes

Durable, high quality fiberglass tapes in ABS plastic windup cases. Calibrated on one side in cm, on the other in inches. Useful for outdoor activities, track and field, rough terrain and water. Will not tear, break, rust or stretch.



**665V90** 10 metres / 33 feet



**666V90** 30 metres / 100 feet



**667V90** 50 metres / 165 feet

Minimum order: € 400,-

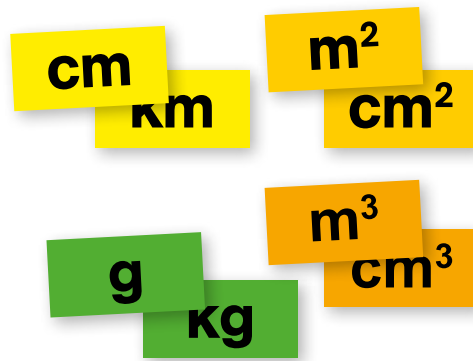

**Conversion Chart**

Show your children how to convert length, area and volume from one unit to another.

**Content:**

- 1 magnetic chart (105 x 33 cm)
  - 40 unit cards (8 x 4 cm) e.g. cm, cm<sup>2</sup>, cm<sup>3</sup>, g
  - 46 number cards (8 x 4 cm)
  - 1 comma
  - 1 question mark to spot the unit
- 87566V90**

# LENGTH, AREA AND VOLUME

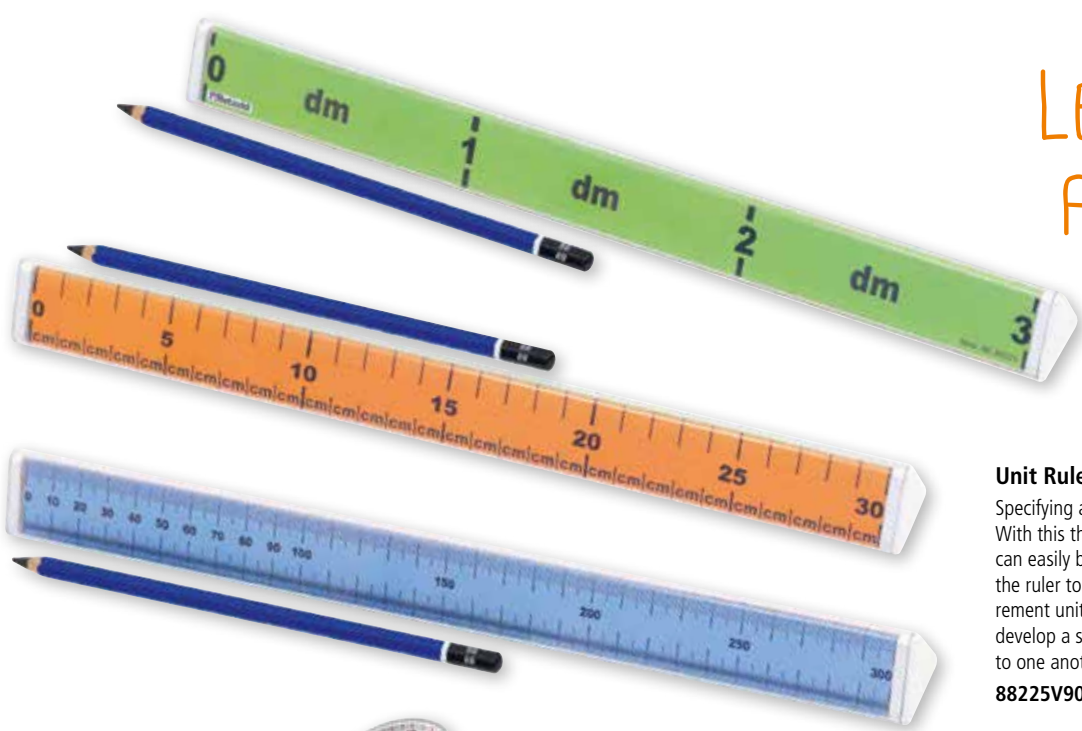

**Unit Ruler**

Specifying accurate measurement units  
 With this three-sided ruler different measurement units can easily be defined. To convert between units, just flip the ruler to the next side and then decide which measurement unit is logical and the most exact. Students can develop a sense for measurement units and their relation to one another.

**88225V90**



**Measuring Tape**

Made of tear-proof fibre glass. 1.5 metres

**668V90**



**School-Tachometer with Counting Mechanism**

Improve children's sense of distances! Let them walk, roll the tachometer and measure different distances. After each metre they hear a click. Counting mechanism up to 99,999 metres.

Tachometer with rubber tyre and adjustable grip.  
 Diameter: 31.8 cm

**82008V90**



**Theodolite**

Surveying in schools with this lightweight and sturdy theodolite for outdoor use. The sturdy adaptable legs are telescopic for storage. The level indicator ensures precise set up. The scales move and measure with an accuracy of 1°. Comes with instructions.

Dimensions:  
Base protractor: Ø ca. 30 cm  
Height: max. 125 cm

**86421V90**

Minimum order: € 400,-



1»

MAGNETIC

### Euro Coins and Notes

These large Euro coins and notes are full coloured and have a complete magnetic backside. The huge size notes and coins are ideal for demonstrating money sized to students.

#### Features

- › Realistic notes and coins
- › Suitable for all magnetic boards
- › Good value for money

All sets consist of:

Euro-Notes: 5x 5 €, 10x 10 €, 5x 20 €, 5x 50 €, 10x 100 €, 5x 200 €

Euro-Coins: 10x 1 €, 5x 2 €

Euro-Cents: 10x 1 Ct, 5x 2 Ct, 5x 5 Ct, 10x 10 Ct, 5x 20 Ct, 5x 50 Ct

Signs: 4x +, 4x -, 6x =, 2x x, 2x :, 2x ·

### 1» Euro Organiser with Magnetic Notes and Coins

Dimensions: organiser: 80 x 32 cm

note: 10.2 x 20 cm, coin: Ø 8 cm

**88079V90**

### 2» Magnetic Euro Money

In cardboard box

Dimensions note: 10.2 x 20 cm, coin: Ø 8 cm

**87935V90**

### 3» Euro Case with Magnetic Notes & Coins

Dimensions:

case: 34 x 30 x 6 cm

note: 10.2 x 20 cm, coin: Ø 8 cm

**89844V90**



3»

MAGNETIC

2»



MAGNETIC

### Euro Shopping – Demo, magnetic

A demonstration tool about buying and selling.

There are 6 objects with a certain price.

There are 10 different lists with a combination of items and an amount of money they have to pay with.

The children have to find out how much the combination of items would cost.

And how much money they would have left in their wallet. For every list there is a correction sheet enclosed.

There are 2 sets – one without decimals and one with decimals.

#### Content:

6 objects with a certain price

10 lists

10 correction sheets

Dimensions (W x H): 17 x 24 cm

**87577V90** Set 1: without decimal

**87593V90** Set 2: with decimal



**BEST  
SELLER**

### Euro Organiser

Dimensions (H x W x D): 2.5 x 45 x 20 cm

- › Children can organise the storing of the euro money.
  - › The organiser is made of plastic with a transparent lid.
  - › Especially developed for the euro money: 7 compartments for the notes and 8 compartments for the coins.
- All Warning Notice: 1 (page 271)

- 2463V90** Sorting tray with 130 notes and 160 coins
- 2832V90** Sorting tray with 65 notes and 110 coins

### Euro Coins

Realistic looking coins, made of sturdy plastic  
Diameter 2 €: 2.6 cm  
All Warning Notice: 1 (page 271)

- 2512V90** 300 coins in a plastic bag
- 1991V90** 80 coins in a plastic bag



### Euro-Notes

Printed on both sides, made of non tearable paper,  
9 to 12 cm long.

Set contains 10 of each and 15 of 10 €

**900043V90**



# CALCULATING WITH MONEY

### Shopping Time

The children get a shopping list and an amount of money.  
They have to buy the objects on the list and have to pay.  
The exercise is to add the prices and to get the right amount of money back! On the back side of the shopping list they find the solution!  
2 different sets each with 36 object cards and 72 shopping lists.  
Each set is packed in a 'learn'-box.

- 86698V90** Set 1: Easy Set (without decimal)
- 86688V90** Set 2: Advanced Set (with decimal)

Minimum order: € 400,-

MAGNETIC



### Counting with the Piggy Bank

How can you get 92.00 € if you have to use 3 coins and 3 notes?

This set includes a piggy bank, 10 work cards (5 with decimal and 5 without decimal) and 4 blank cards to make your own exercises.

Dimensions of the piggy bank: 27 x 29 cm

Dimensions of the cards: 11 x 16 cm

**88086V90**



### Euro Divider

Try to find how to compose a certain amount. The number of notes and coins is indicated.

On the verso side you can find the solution. To be used with the euro-organisers.

There are 2 sets – one without decimal and one with decimal.

**Content:** 25 exercises in a plastic box  
Dimensions (W x H): 9 x 7 cm

**87576V90** Set 1: without decimal

**87592V90** Set 2: with decimal



### Calculating Money Swiss Franc, incl. Cash

Plastic coins and calculating notes, helps children to get an understanding of money management.

Notes:

10 x 1000 CHF, 20 x 200 CHF, 20 x 100 CHF, 20 x 50 CHF, 20 x 20 CHF, 20 x 10 CHF

Coins: 20 x 5 centimes, 20 x 10 centimes, 20 x 1/2 CHF, 20 x 1 CHF, 20 x 2 CHF, 20 x 5 CHF

Cash box size (H x W x D): 3.5 x 19 x 45 cm

Warning Notice: 1 (page 271)

**759605V90**



### Swiss Francs

All Warning Notice: 1 (page 271)

**757463V90** Set of 55 notes

**760432V90** Set of 70 coins

**760439V90** Set of 325 notes

### Clock: In the Course of a Day

Children see and understand that their activities are linked to different times of a day. This way they develop a sense of time and learn how to calculate with periods of time. "When do you have breakfast? When does school begin? And how big is the time gap between these events?" 26 appealing magnetic pictures show familiar activities of children's daily routine. Place them on the board and create the course of a day.

**Content:**

- 1 magnetic board (71 x 71 cm)
  - 1 set of magnetic hands
  - 26 magnetic pictures (8 x 8 cm)
- 87289V90**

### A Child's Day

Magnetic Picture Cards

Set of 26 colourful, magnetic cards feature children actively participating in everyday routines, activities, and events.

The pictures are an effective tool for helping children increase their expressive language skills and vocabulary by allowing them to "talk about" experiences with which they are familiar. Dimensions: 8 x 8 cm

**87253V90**



# WHAT'S THE TIME?



### Teaching Clock "What's the time?"

Get to know different time expressions! The 2 hands and 6 time expression tags are removable. This allows an easy start of the subject "time". First only set in the hands to get used to full hours. Then add one tag after another. Your pupils understand step by step "half", "quarter", "past" and "to".

**Content:**

- 1 magnetic teaching clock printed on sturdy foil (dimensions: 63 x 48 cm) with 2 hands and 6 time expression tags.
- 87568V90**



Minimum order: € 400,-

**BEST  
SELLER**

**MAGNETIC**



**Magnetic Demo Clock**

This 41 cm large clearly-defined clock is perfect for classroom demonstrations.



The hands are synchronised.  
On the backside of the clock are 4 strong magnets, so this clock can be hung on any magnetic board.

**2619V90**

**Student Clock**

Student version of the big clock, diameter: ca. 13 cm  
Small clock with a stand.  
Hands move synchronically.  
Warning Notice: 1 (page 271)

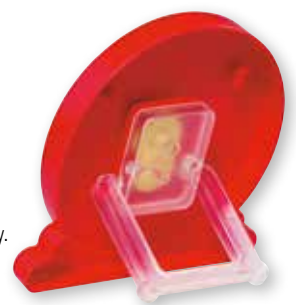

**85444V90**

# TEACHING CLOCKS - SIMPLE TO USE AND EASY TO READ



**Sand Timers**

How long is a break of 5 minutes? How long are 30 seconds if you are standing on one leg? 10 minutes of reading ... Make time visible and let children experience time.

All Warning Notice: 1 (page 271)

- 758679V90** 30 sec red
- 758680V90** 1 min green
- 758681V90** 2 min pink
- 758683V90** 5 min blue
- 758684V90** 10 min orange
- 758685V90** 15 min purple
- 758686V90** 30 min black
- 757697V90** 45 min turkise

**Sturdy case with 5 sand timers**  
(1, 2, 3, 5 min and 30 sec)

**758697V90**

**Sturdy case with 3 sand timers**  
(1, 15 and 30 min)

**758698V90**





### Pair of Magnetic Clock Faces

Shows analogue and digital time. Perfect for calculating periods of time.

Includes 2 large clock faces, 2 sets of magnetic hands and a set of magnetic numbers (57 pieces) for the digital clock.

Dimensions: 30 x 36 cm

87242V90



### Pupil Clock Set of 10

Make teaching time in the classroom easier with this set of sturdy plastic clock faces. Movable hands show hours and minutes. Set of 10 pupil clocks.

Dimensions: 11 x 11 cm

87333V90



### Student Clock

Ø ca. 11 cm

Hands are protected by a transparent cover. They are moved synchronically by a button on the top.

5453V90



### Individual Clocks

Dimensions (W x H): 9 x 12 cm

- › Made from sturdy plastics
- › Moveable hands have a different colour
- › Surface can be written on
- › A space to write the digital time

369V90

Set of 10



Minimum order: € 400,-



### Double-sided Isometric Geoboard

#### stackable

One side has 11 x 11 pins on 2 cm raised grid, other side pins are in an isometric array to allow work with isosceles triangles.  
 Dimensions: 20 x 20 cm, made of durable polypropylene.  
 All Warning Notice: 1 (page 271)

**86246V90** piece

**89733V90** Set of 8 boards

### Rubber Bands

In polybag

**40264V90** 265 pieces in 5 colours and 4 sizes

## GEOBOARDS IN VARIOUS SIZES

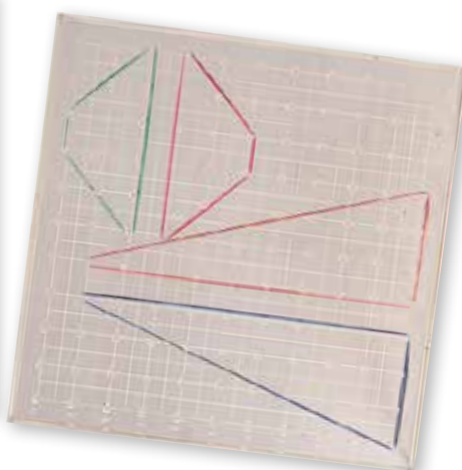

### Geoboard, 22.5 cm

Transparent, with 121 pins in a square grid  
 Can be used on the OHP.  
 Warning Notice: 1 (page 271)

**881V90**



### Double-sided Geoboard, 17.5 cm

On one side 25 pins are arranged on a square grid. Children can make all basic shapes with the rubber bands.  
 To compare surface, corners and discover symmetry.

The reverse side shows a circular pin arrangement.  
 To discover the properties of circles.

Ideal resources for an introduction in fractions.  
 Warning Notice: 1 (page 271)

**912V90**



### Double-sided Geoboards

On one side the pins are arranged in a square grid, on the other side they are arranged isometrically.  
 Dimensions: 23 x 23 cm

Warning Notice: 1 (page 271)

**759555V90** Set of 6 in 6 bright colours

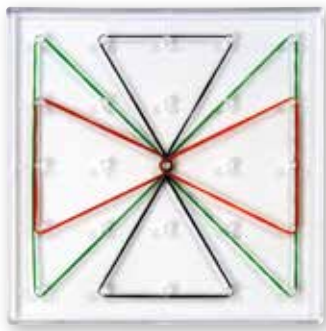

### Geoboard, 15 cm, Square

Transparent, with 25 pins in a square grid.

Can be used on the OHP.

Warning Notice: 1 (page 271)

895V90



### Geo-Me

Students can build and explore geometric shapes. Each shape is placed inside a two-piece frame. As the pieces are transparent you could use them on a light table.

108 parts

760356V90



### Work Cards Geoboard Square

12 cards printed recto verso

3 sets of 12 cards – increasing in difficulty

Dimensions: 16 x 16 cm

Geo mirror not included.

81942V90 Set 1 – Only 1 Rubber Band

81946V90 Set 2 – More Rubber Bands

81947V90 Set 3 – Work with a Geo Mirror

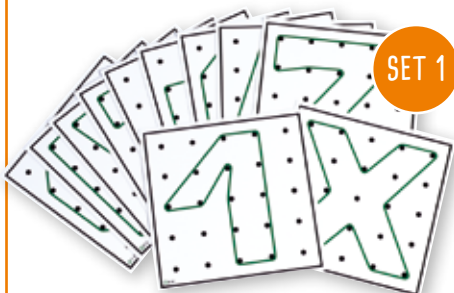
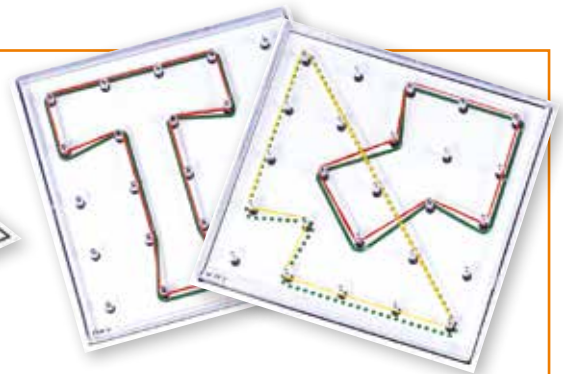
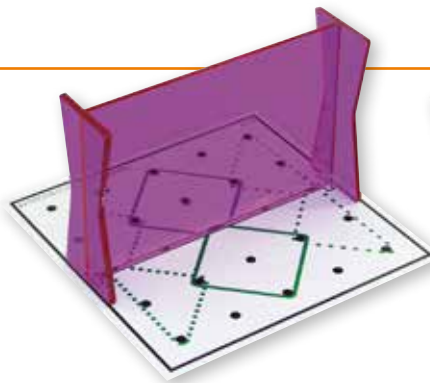

SET 1

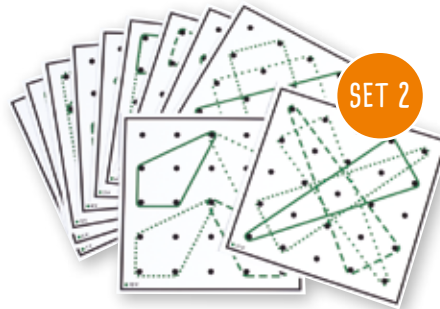

SET 2



SET 3

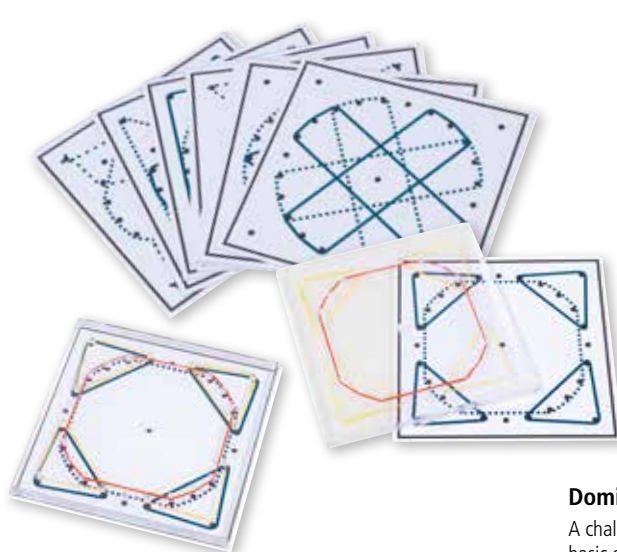

### Work Cards Geoboard Circle

12 cards printed recto verso – increasing in difficulty

Dimensions: 16 x 16 cm

87967V90

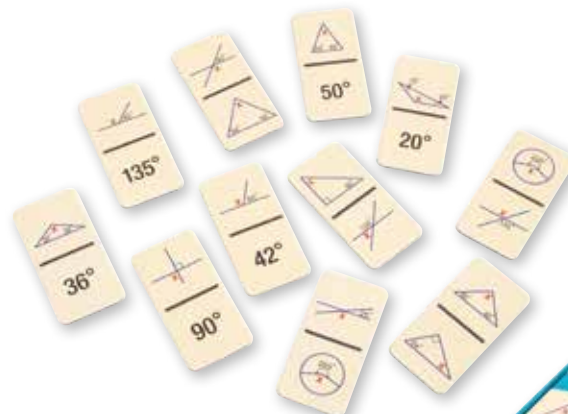

### Domino Triangles & Angles

A challenging domino game! The students will develop basic geometry skills, such as: understanding of the sum angle of a triangle, complementary angles and vertical angles.

2–4 players

Content: 40 domino tiles

760361V90



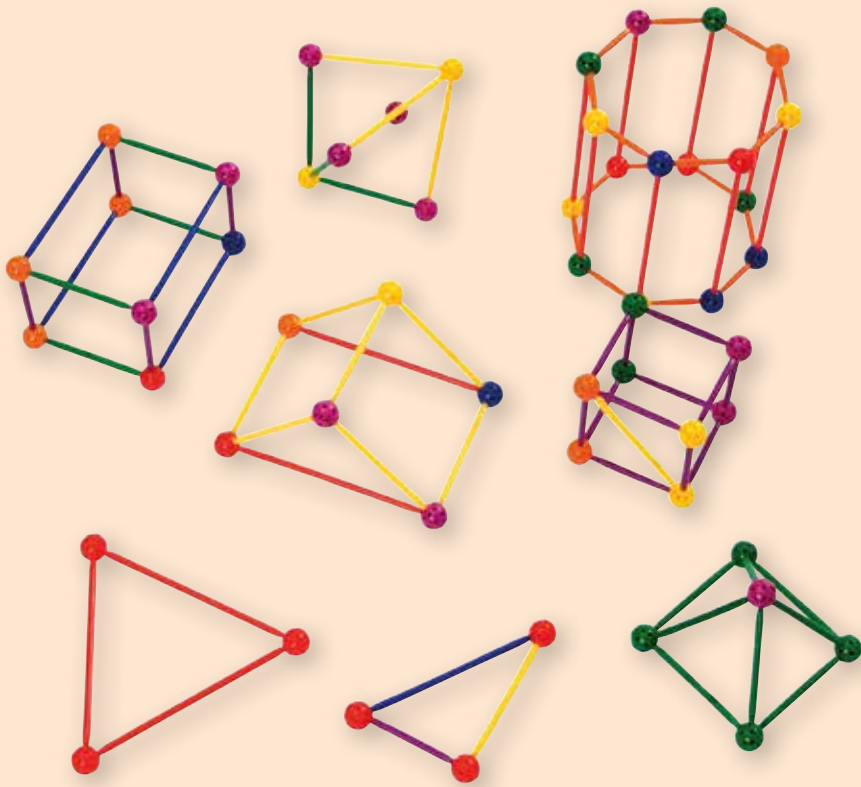

# GEOMETRY

## Stick and Ball Geometry Kit

Use to make geometric shapes or create models. Each stick colour is a different length, making it possible to design various polygons of differing sizes.

### Content:

250 Sticks (40 orange, 45 purple, 45 green, 40 yellow, 40 blue, 40 red)

80 balls (14 orange, 14 purple, 13 green, 13 yellow, 13 blue, 13 red)

Warning Notices: 1, 5 (page 271)

**87071V90**

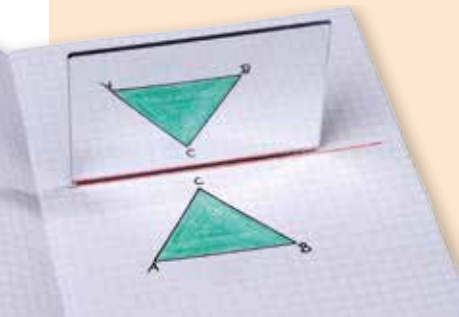

## Unbreakable Handmirror

Class pack

All Warning Notice: 2 (page 271)

**5534V90** Dimensions (W x H): 10 x 7 cm, Set of 25

**88429V90** Dimensions (W x H): 15 x 10 cm, Set of 10

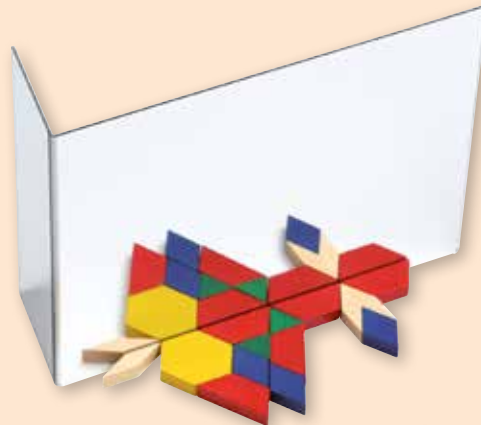

## Unbreakable Mirror

Can be used two ways.

Dimensions (W x H): 10 x 16 cm

Warning Notice: 2 (page 271)

**86359V90**

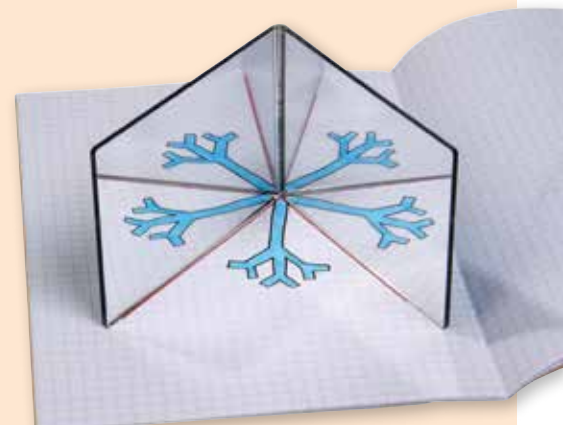

## Double Mirror

With two flexible parts.

Dimensions (W x H): 20 x 7 cm

Warning Notice: 2 (page 271)

**349V90**



## Pattern Blocks

1 cm thick.

Wooden pattern blocks – set with 250 pcs.

Warning Notice: 1 (page 271)

**900346V90** In plastic storage tub

## Pattern Blocks

0,5 cm thick.

Plastic pattern blocks – set with 250 pcs.

All Warning Notice: 1 (page 271)

**85047V90** In plastic storage tub

**1000V90** In plastic bag

### 1) Double Mirror

This flexible mirror (15 x 15 cm) introduces children to symmetry and other concepts. Can be used with colour cubes, pattern blocks and other manipulatives. The plastic mirrors are mounted on wood. Warning Notice: 2 (page 271)

41345V90

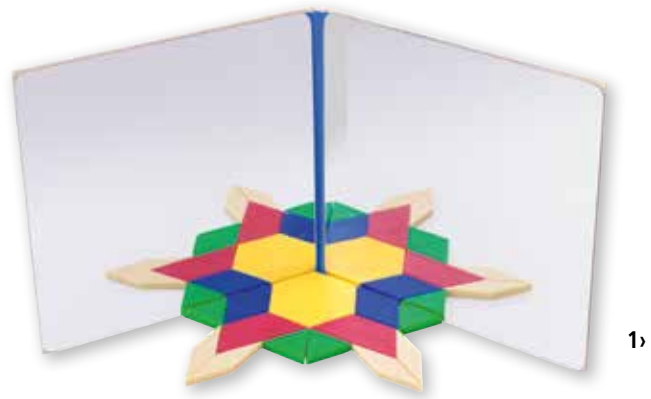

### 2) Corner Mirror

Students can use these mirrors with pattern blocks, cubes etc. to visualise and understand symmetry, reflections and patterns.

Warning Notice: 2 (page 271)

**Content:** 2 mirrors (10 x 15 cm), 1 wooden base (16 x 16 cm)

85851V90



### 3) Reflecting Patterns

The child has to put the needed pattern blocks in such a way that the requested pattern on the card appears. To familiarise the children with symmetry and reflections.

**Content:**

8 cards (15 x 10 cm) – printed recto verso  
16 exercises – showing the result of putting the shapes before the mirror. Indicated is also how many blocks of which kind you need. In the right corner you find the solution of the exercise from the other side.

87578V90



### Geo Mirror

Surface reflects like a mirror, but you can see through it. Place this mirror in front of a shape or a design. Put your pen on the other side of the mirror on a piece of paper (see picture). Look through the mirror. You can see the shapes and -through the mirror- your pen. Now you can start drawing. To discover geometric shapes and their symmetry, similarity ...

Made from acrylic glass. A rounded side makes drawing easier. Dimensions (W x H): 15 cm x 9.5 cm

863V90



**BEST SELLER**

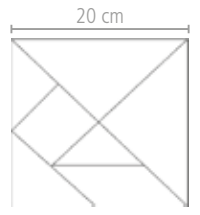
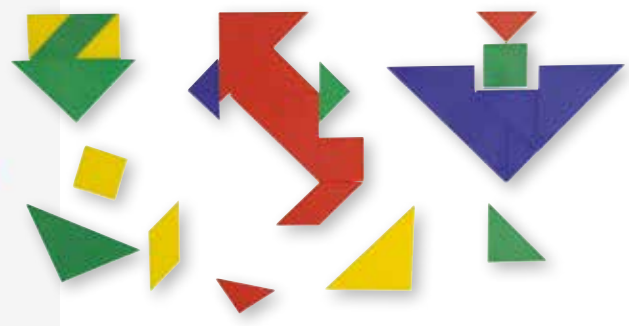

**Magnetic Tangram**

This magnetic tangram can be used on steel based whiteboards, blackboards, desk tops ... From seven basic geometrical shapes children are able to create various images, from simple to challenging. Great for demonstrating on the board while students work at their desks. Set of 3 tangrams in 3 different colours (coloured on both sides)

**86250V90** Set of 3

# Tangram - SEVEN PIECES OF CLEVERNESS

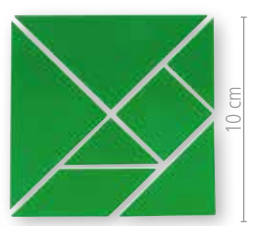
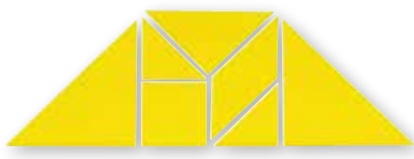

**Tangram**

Made from colourful and very sturdy plastic. Each set contains 28 pieces (= 4 tangrams – each 7 forms) in the colours red, yellow, blue and green (dimensions: 10 cm) To create basic shapes and colourful illustrations.

Warning Notice: 1 (page 271)  
**85033V90** In a plastic box with lid

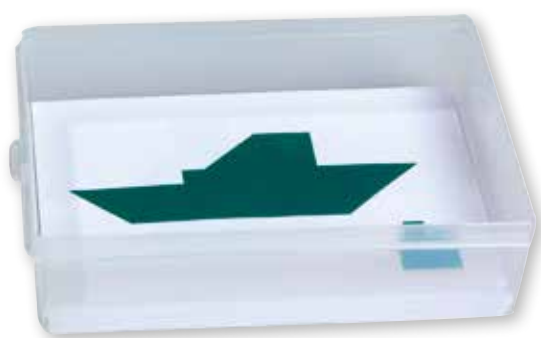

**Tangram Work Cards**

printed on plastic (17 x 14 cm)

25 cards printed on both sides. This means 50 exercises. The solution is printed smaller on the reverse side and space is left between the different parts.

**85043V90** With box

**9736V90** Without box



### Pentominoes

To develop concepts of logic, area and space.

60 pieces in 5 different colours

Warning Notice: 1 (page 271)

**9882V90** In plastic tub with lid

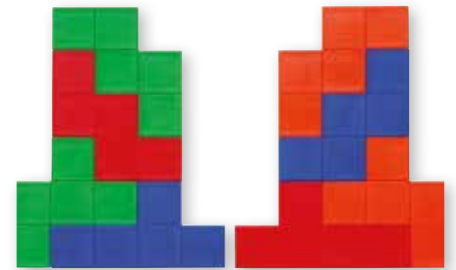
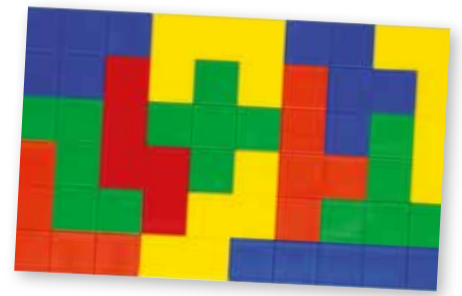
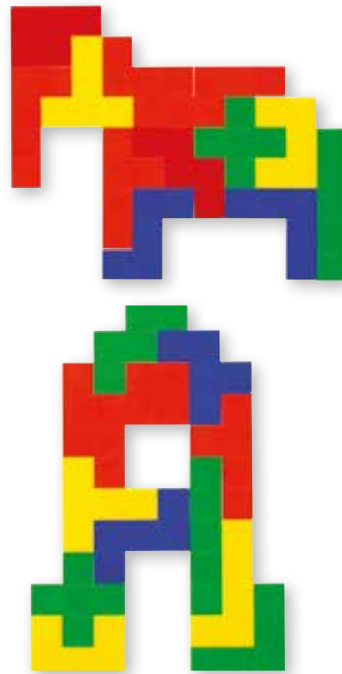

### Pentomino Work Cards

**Content:** 15 cards – printed both sides (14 x 17 cm)  
I.e. 30 exercises – solution is on the back side in small

**85584V90 Set 1:** Different number of tiles – from 3 up to 12

**85585V90 Set 2:** Exercises with all 12 tiles  
On 10 exercises there are 2 or more tiles indicated as a help.

**86928V90 Set 3:** Try to make the same pattern with different pieces.

**86929V90 Set 4:** 2 sets of pieces lead to the same pattern. Try to find out how.

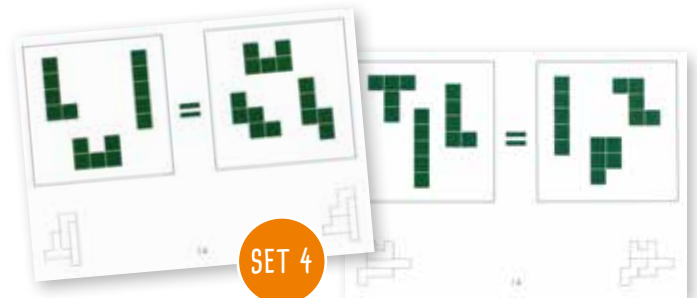
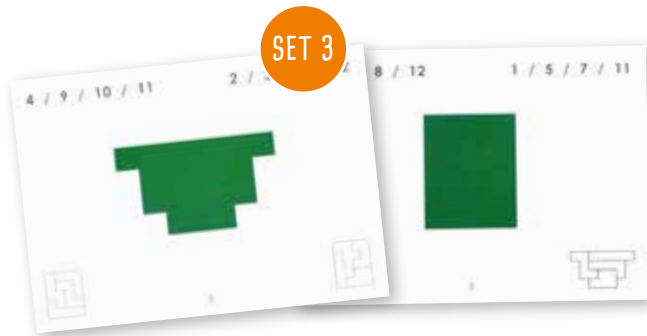
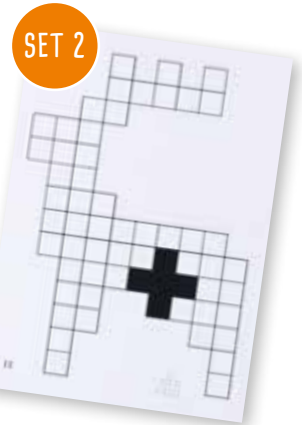

### Make your own Tangram

Tangram for sawing and painting. Made of plywood.

Dimensions: 15 x 15 cm

**51565V90**

Minimum order: € 400,-



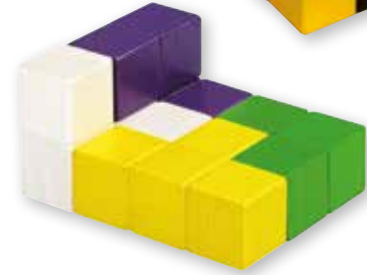
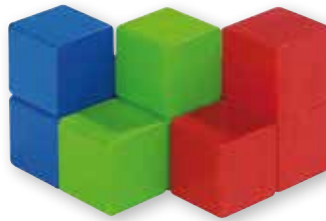
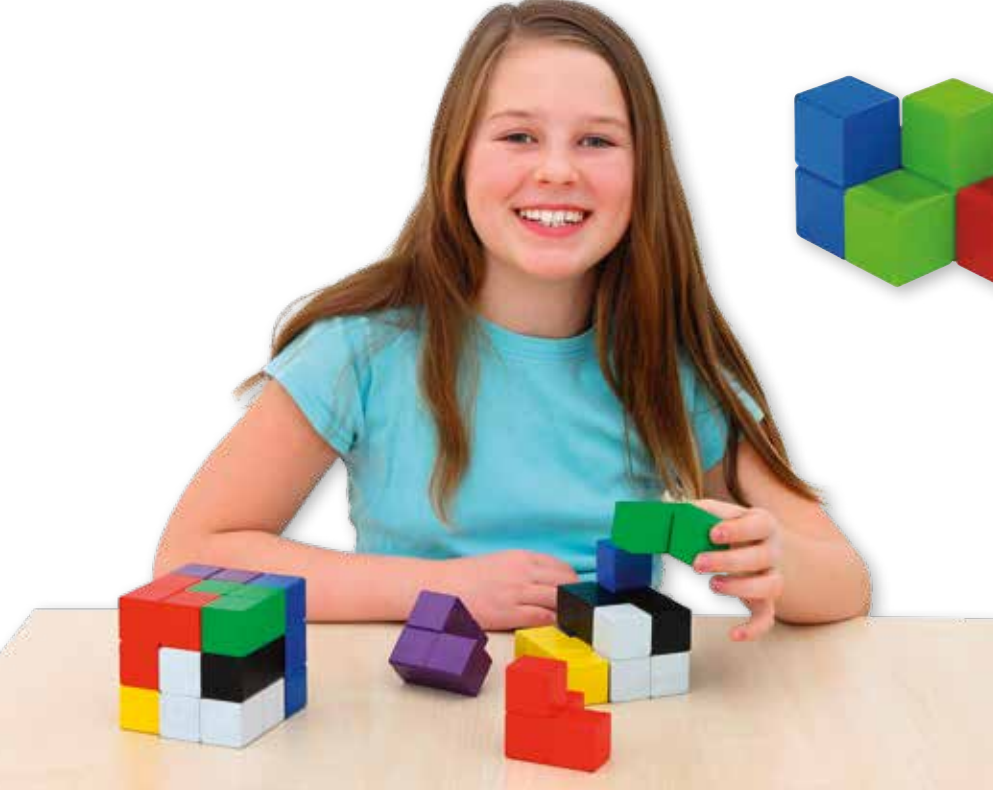

### Soma Cube

The Soma cube is a solid dissection puzzle. Seven pieces made out of unit cubes must be assembled into a cube. The pieces can also be used to make a variety of other interesting 3D shapes.

**89190V90** Large – 9 x 9 cm

**86410V90** Small – 6 x 6 cm

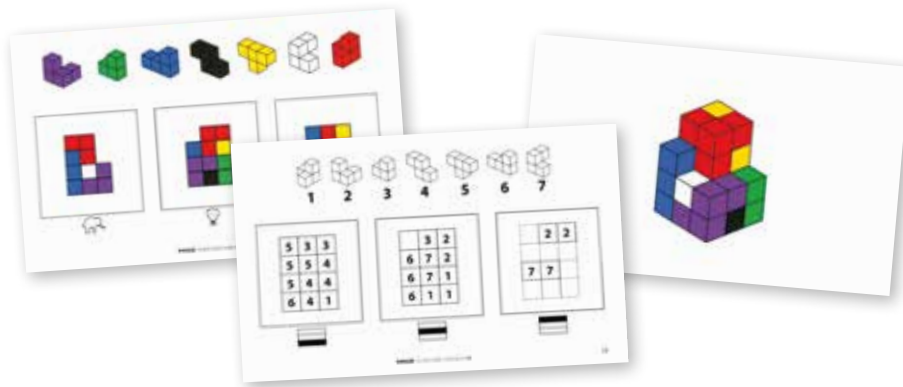

### Soma Work Cards

Based upon the info on the front side, you have to build the right construction. Afterwards you can check the job by comparing the figure on the other side with the built figure. Dimensions: 21 x 13 cm

4 sets of work cards – increasing in difficulty. Each set consists of 10 self-correcting cards.

**86300V90** Set 1

**86301V90** Set 2

**86302V90** Set 3

**86303V90** Set 4



### Wooden Geometric Solids with Shapes

#### Content:

- › 7 solids: cube, cuboid, sphere, cylinder, cone, three-sided and square-based pyramid. Height up to 7.5 cm
- › 4 base shapes. Dimensions square: 5 x 5 cm

Warning Notice: 7 (page 271)

**87267V90**



### Wooden Geometric Solids

**Content:** cones, sphere, hemisphere, cube, cylinders, different pyramids, different prisms and rectangular shapes. To explore relationships between area, volume and shape.

Height: up to 7.5 cm; diameter: up to 5 cm

Warning Notice: 7 (page 271)

**89022V90** Set with 12 models



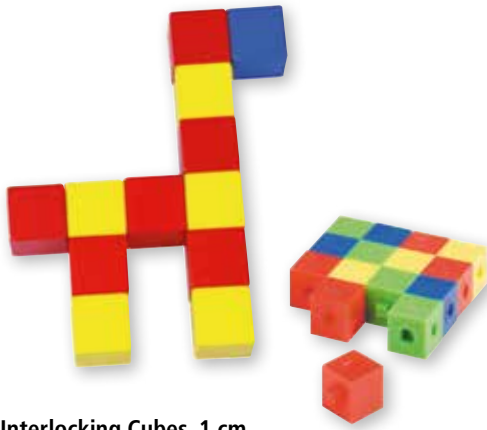

### Interlocking Cubes, 1 cm

Ideal material for first mathematical discoveries: comparing quantities, sorting, matching, counting ...

Since these cubes have a side length of 1 cm, a weight of 1 g, they can be used to introduce linear as well as weight concepts.

**Content:** 1000 pcs., in 10 bright colours

Warning Notice: 1 (page 271)

**5953V90** In plastic storage tub

### Interlocking Cubes, 2 cm

In bags of 100 pcs.

All Warning Notice: 1 (page 271)

**87224V90** 5 different colours

**35838V90** 10 different colours



### Wooden Cubes

150 wooden cubes of 2 cm

Warning Notice: 1 (page 271)

**761794V90** In plastic storage box

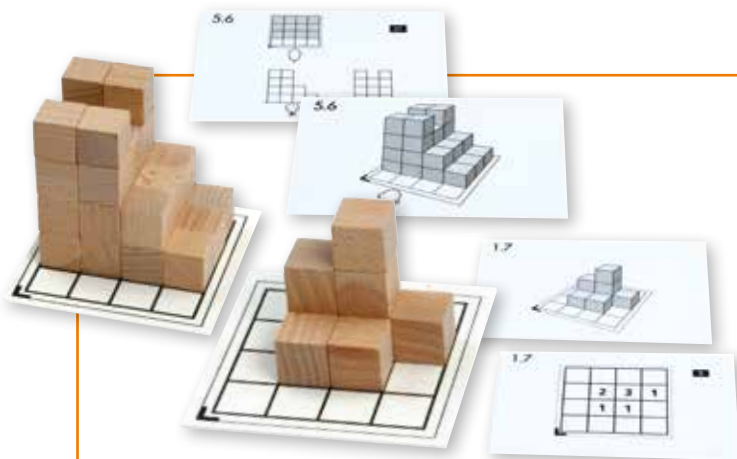
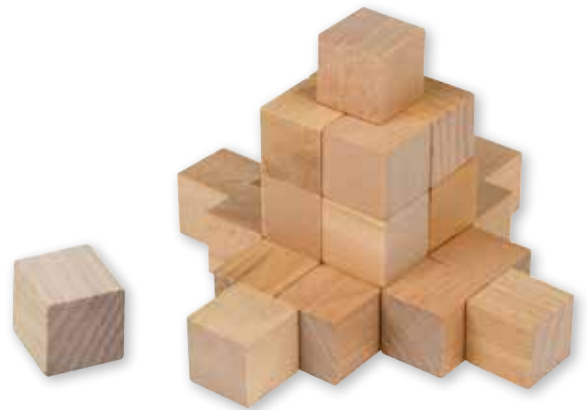

### Cubo – Work Cards for the Wooden Cubes

Build a construction based on info from different angles!

On the verso side you find the right solution. Different sets use a different amount of blocks!

Dimensions: 13 x 9 cm

5 sets of work cards – increasing in difficulty.

Each set consists of 10 work cards, 2 boards, 2 blank cards

**85733V90** Set 1

**85734V90** Set 2

**85735V90** Set 3

**85736V90** Set 4

**85737V90** Set 5



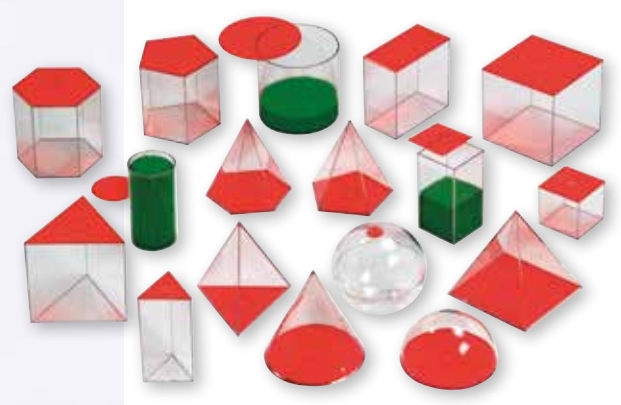

**Geometric Volumes**

Height: 10 cm  
 Ideal tools to measure and compare the volume relationship (and volume formula) between various shapes. The lid enables the students to fill the shape with liquid or dry materials.  
 Includes 17 large volumes, up to 10 cm height.  
 Warning Notice: 7 (page 271)

**86295V90**



**Geometric Volumes**

Ideal tools to measure and compare the volume relationship (and volume formula) between various shapes.  
 The lid enables the students to fill the shape with liquid or dry materials. Includes 17 small volumes, up to 6 cm height.  
 Warning Notice: 7 (page 271)

**86294V90**



**Large Geometric Shapes**

Set of 17 shapes for exploring geometry. The shapes have a common 10 centimetre dimension to show the relationships between area, volume, shape, form and

size (except the small cube). The set includes all shown solids.  
 Warning Notice: 7 (page 271)  
**86272V90**



**Handy Geometric Solids**

A great deal of geometric solids. Ideal for touching, studying, sorting and comparing.  
 40 plastic solids: 10 different forms (cube, cuboid, cone, sphere, hemisphere, three- and four-sided prism, three-sided and square-based pyramid, cylinder) in 4 colours, height: 2.5 cm  
 Warning Notices: 1, 5, 7 (page 271)

**87269V90** Set of 40 pieces



SET 1

**Set 1**

198 pieces: 28 equilateral triangles, 14 right-angled triangles, 28 isosceles triangles, 84 squares, 28 rectangles, 8 pentagons, 8 hexagons  
7597V90

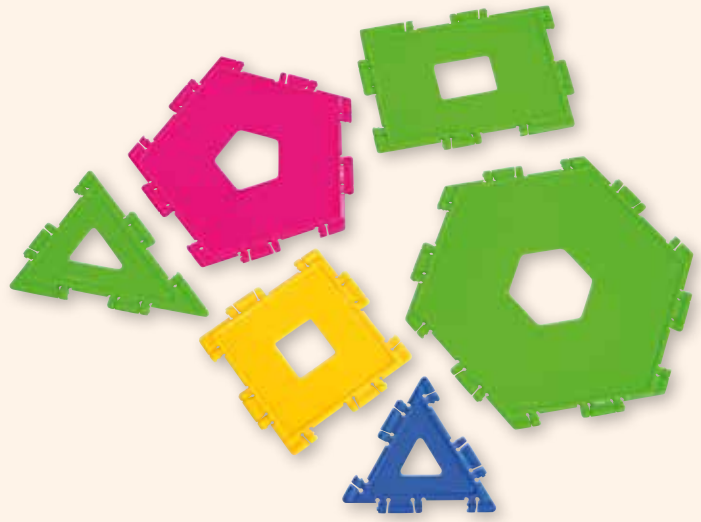

The children discover and investigate a variety of different mathematical areas including shape and space, patterns and colours, sorting and classifying and problem solving.

**Xeo Class-Kit**

7 geo shapes which can be fixed together, edge to edge. Each shape has a hole in the centre for easier shape-recognition, handling and tracing. The shapes are made from durable plastic material.

SET 2



**Set 2**

392 pieces: 56 equilateral triangles, 28 right-angled triangles, 56 isosceles triangles, 168 squares, 56 rectangles, 14 pentagons, 14 hexagons  
7595V90



**Set 3, transparent**

198 pieces: 28 equilateral triangles, 14 right-angled triangles, 28 isosceles triangles, 84 squares, 28 rectangles, 8 pentagons, 8 hexagons  
756134V90





### Giant Construction Kit

Simply connect the balls and sticks to giant constructions! Discover geometric solids and inspect them even from the inside!

Set with 69 pieces: 28 balls (Ø 6.5 cm) and 49 rods (40 cm) made from sturdy plastic

Age: 5+

**756663V90**

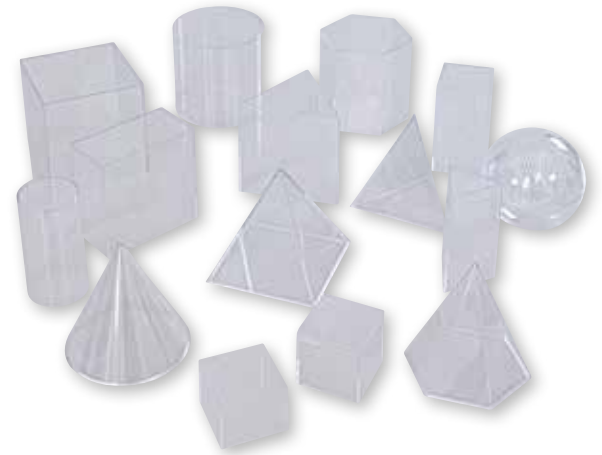
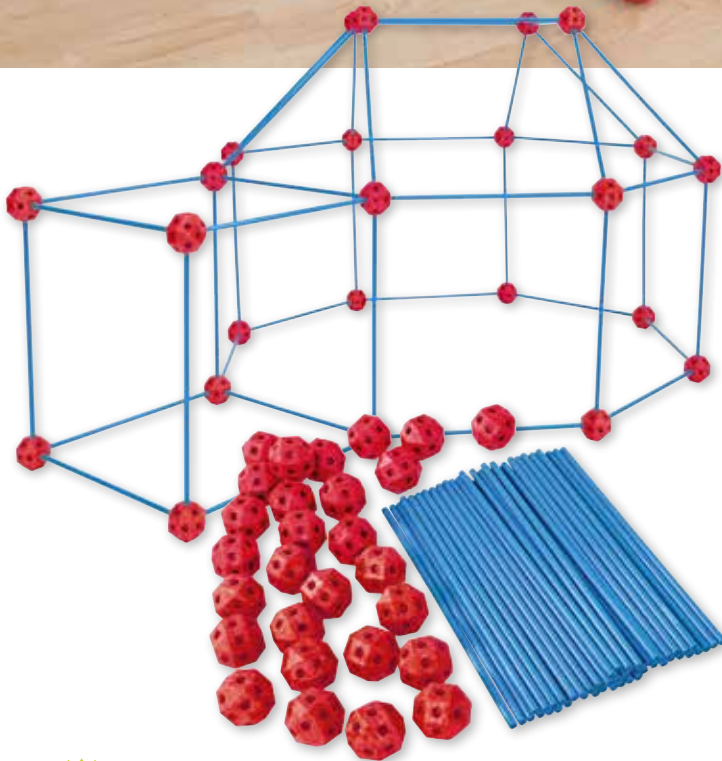

### Extended Volume Set

15 models made of plastic. Shapes measure up to 10 cm height.

Warning Notice: 42 (page 271)

**2632V90**

**NEW**

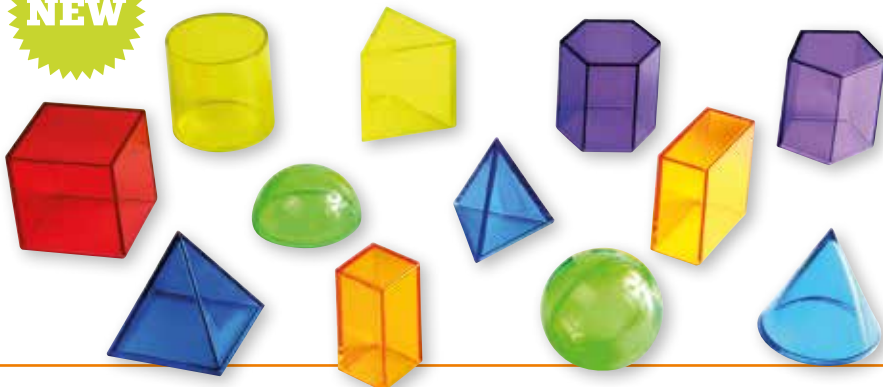

### Set of 12 Three-dimensional Translucent Shapes, 6 Colours

Ideal to get an understanding of geometry concepts from an early age.

Shape height: 5 cm

Warning Notice: 42 (page 271)

**759553V90**



### Connecting Balls and Rods

To discover cubes, pyramids, prisms ...  
 To explain notions as angles, base, areas, sides, heights and diagonals.  
 Each ball has 26 holes.  
 It's very easy to connect the balls and rods.

180 coloured balls (Ø 1.6 cm)  
 180 rods from 1.6 to 7.5 cm  
 Made from sturdy plastic.

Warning Notices: 1, 5 (page 271)

**2182V90** Set

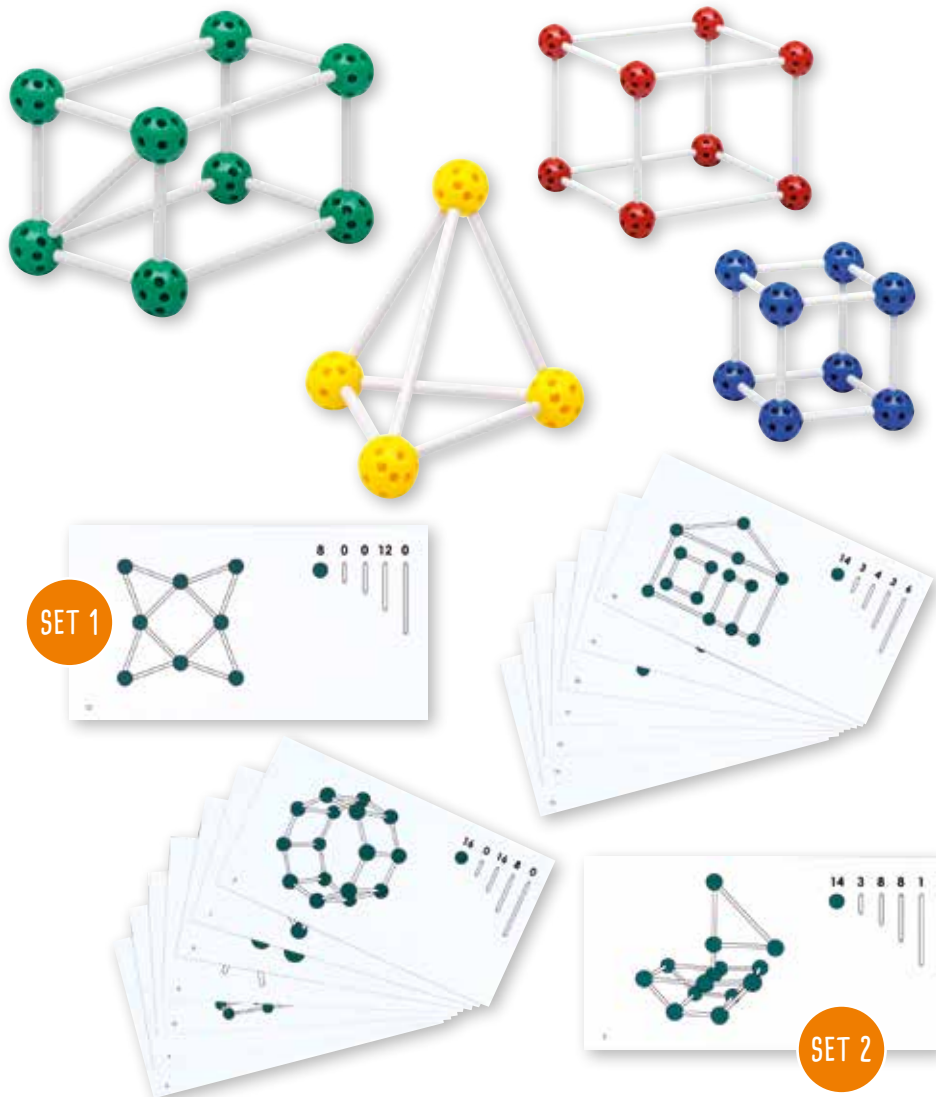

### Work Cards for Connecting Balls and Rods

Study the cards carefully and construct the pictured examples to improve spatial orientation and awareness. This is also important for writing letters and numbers.

#### Set 1 – Plain shapes

10 work cards, printed on both sides, full-scale pictures, self-correcting. Dimensions (W x H): 13 x 24 cm

**81951V90**

#### Set 2 – Solids

10 work cards, printed on both sides, all required pieces are stated on each card. Dimensions (W x H): 13 x 24 cm

**81952V90**

Minimum order: € 400,-

MAGNETIC



## Determining Trees

Based on roots, plant heights, stem, crown, leaf, blossom or fruit each tree can be determined exactly.

With this specially developed learning material for the school, it's even easy to do it in the classroom.

The scaled and sturdy trees can be used at any time without much preparation. The magnetic plates adhere perfectly to the tree surfaces. Ready-to-use copy sheets complete this great teaching material.

Suitable for bilingual lessons (English, French or German).

754793V90



## Solid Wood Stand-Up Display

The high-quality stand-up display for learning stations is made of solid wood. The slit in the middle is 3 mm wide. Thick carton or multiple sheets of paper fit in perfectly. The weight of 192 g ensures that bigger signs will not tip over.

Dimensions (H x W x D): 5.5 x 10.5 x 5 cm

Weight: 192 g

755330V90



## Floors of the Forest

Learning game for children that shows the layers of a forest.

Wooden box with pop-up lid (H x W x D: 7.5 x 32 x 23 cm)

**Content:** 25 parts

15 animals (fox, roe deer, badger, wild boar, woodpecker, spider, bird's nest, ant, toad, squirrel, earthworm, owl, bee, butterfly) / 6 forest layer pictures: 1 deciduous tree and 1 conifer for tree layer, 1 root for root layer, 1 picture each for shrub layer, herb layer and moss layer / 4 wooden strips (2 with 5 and 2 with 6 grooves)

Copy templates

762049V90

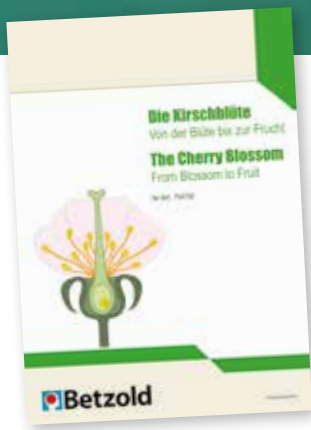
**MAGNETIC**

### Cherry Blossom – From Blossom to Fruit

Demonstrate directly on the blackboard, how and why a cherry blossom becomes a cherry. Each development stage can be explained with this beautifully designed illustration material.

Depending on class level and performance level you can convey knowledge specified and individually.

Show children how the bee crawls into the blossom and sucks up nectar with its trunk or explain in secondary level what a flower diagram is.

Ideal for bilingual school lessons (German/English).

#### Content:

23 magnetic pieces (largest piece: 41 x 33.5 cm); 1 bee, 1 trunk, 4 development stages of the blossom to the fruit, 2 flower diagrams, 15 magnetic name cards (front side German/backside English), 1 handout with copy sheets (German/English)

754792V90

### Cherry Blossom Model

The cherry blossom model made of plastic, placed on the base.

This will facilitate the understanding of the flower.

Well presented elements: the stamens, the ovary.

Dimensions: diameter: 23 cm, height: 22 cm

Material: plastic

86177V90



### Wooden Flower Press

Wooden flower presses in two sizes

The presses are ideal for a lot of crafty uses and suitable for use by adults and children. They are made from MDF wood and come with screws, cardboard and blotting paper.

#### Large Flower Press

**Content:** 2 MDF plates (32 x 26 cm), 8 screws with butterfly nuts, cardboard and blotting paper.

Warning Notice: 2 (page 271)

70787V90

#### Small Flower Press

**Content:** 2 MDF plates (13 x 13 cm), 4 screws with butterfly nuts, cardboard and blotting paper.

Warning Notice: 2 (page 271)

761023V90

Minimum order: € 400,-



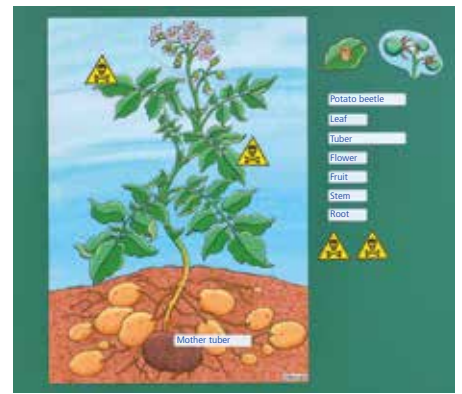
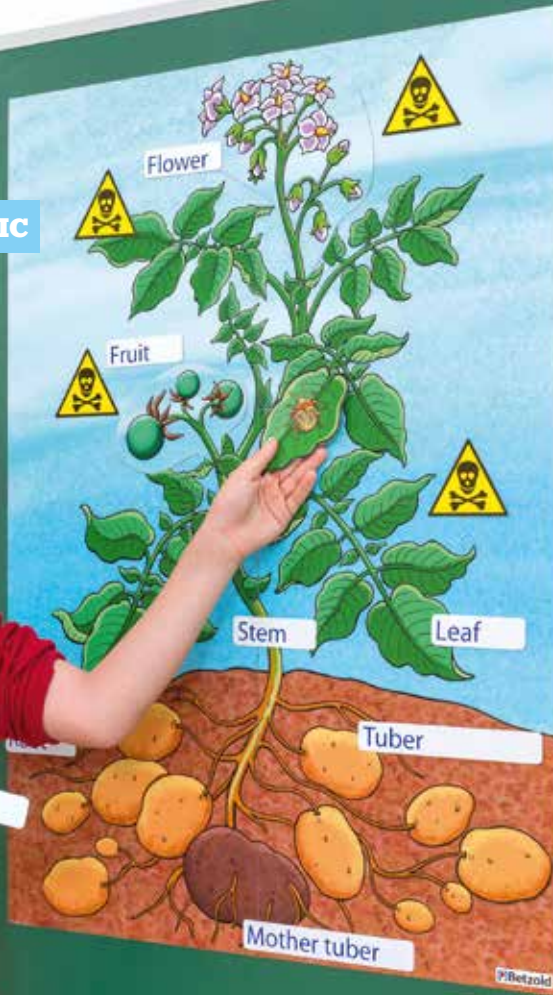

**The Potato Plant**

The "miracle" tuber comes to life fast and extremely large on your blackboard! Demonstrate and name the individual parts of the plant. Which parts are toxic and which beetle causes damage to the plant? The colourful pictures encourage discovering the potato plant. The magnetic name plates are printed both sides (front in German/back in English) and can also be used in English lessons. In the handout you will find interesting facts of the potato plant, copy templates with questions, a guessing game and a potato recipe.

**Content (29 pieces):**

1 large magnetic poster (4 pieces, 57 x 80 cm), 4 removable magnetic plates (blossom, fruit, potato, leaf with potato beetle), 4 toxic plates, 8 magnetic name plates (front in German, back in English), 8 magnetic plates (to be labelled), 1 handout with copy templates.

84910V90

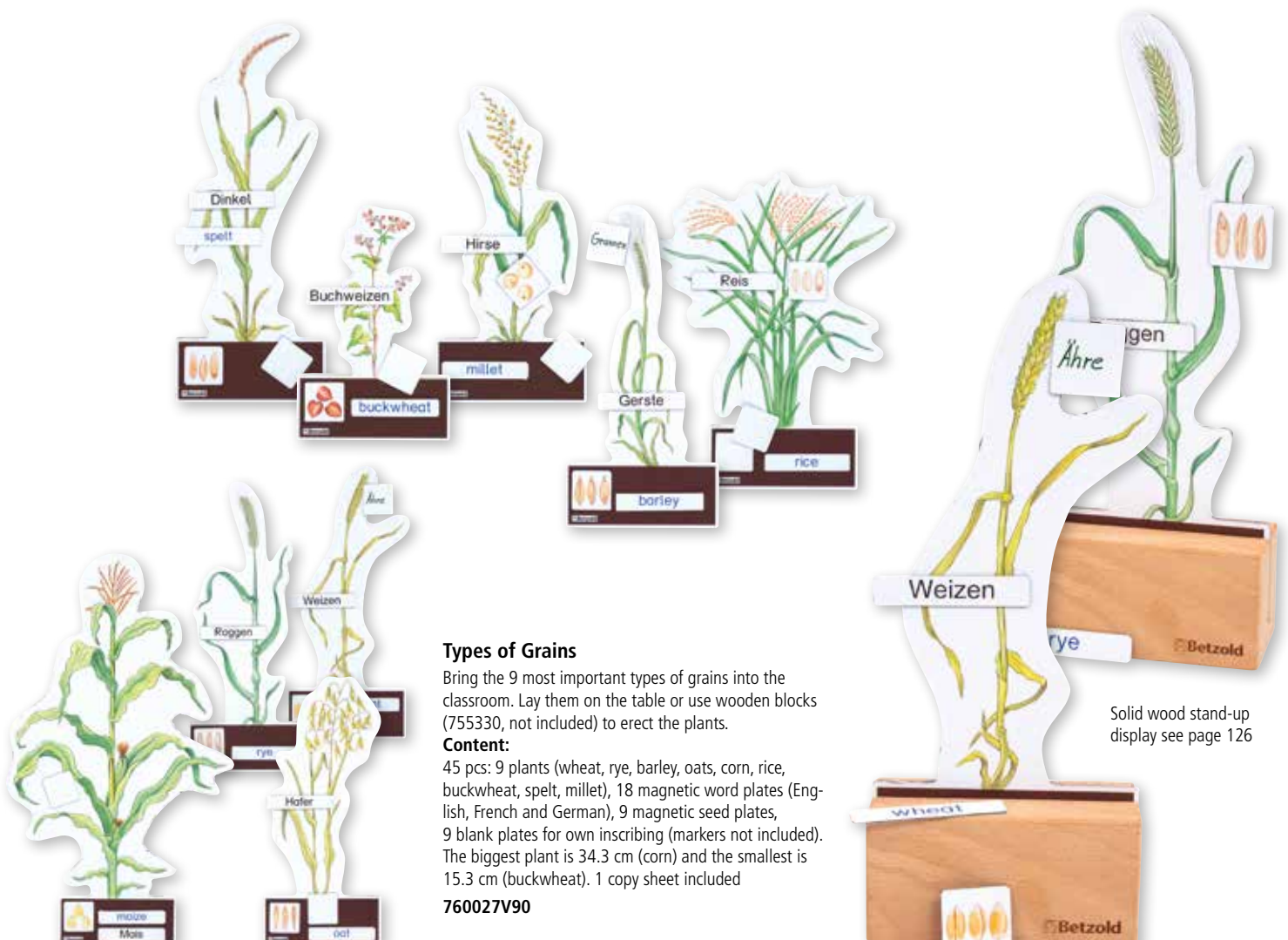

**Types of Grains**

Bring the 9 most important types of grains into the classroom. Lay them on the table or use wooden blocks (755330, not included) to erect the plants.

**Content:**

45 pcs: 9 plants (wheat, rye, barley, oats, corn, rice, buckwheat, spelt, millet), 18 magnetic word plates (English, French and German), 9 magnetic seed plates, 9 blank plates for own inscribing (markers not included). The biggest plant is 34.3 cm (corn) and the smallest is 15.3 cm (buckwheat). 1 copy sheet included

760027V90



Solid wood stand-up display see page 126





### Magnifying Glass

Small magnifier for clear bug and nature viewing that is very comfortable to hold. The big glass (Ø 5.5 cm) magnifies 2x and the small one (Ø 1.5 cm) 8x. Length: 17 cm  
Warning Notice: 2 (page 271)

**84721V90**



### Box Magnifier

Made of clear acrylic plastic. With magnifying top for viewing insects, minerals and other small specimens. Dimensions: 3.8 x 3.8 x 3.8 cm  
Warning Notice: 2 (page 271)

**89180V90**



### Two Way Viewer

Allows children to place small objects such as insects on the tray and view them from below and above.  
Warning Notice: 1 (page 271)

**6573V90**

### Nature Exploring Kit

Observe the natural world around you and draw the children's attention to the environment.

#### Content:

bug jar with magnifier, creature net with 2-piece handle, magnifier, tweezers, instruction manual  
Warning Notice: 1 (page 271)

**85801V90**



### Magnifier Stand

Steady wooden magnifier stand  
Up to 15 magnifiers can be stored properly and safe with this elegant magnifier stand made of solid wood. Magnifiers not included.

**754544V90** big, for magnifier with handle 9993

**754545V90** small, for magnifying glasses 6592, 6593, 6599



### Magnifying Glass

With this magnifier the kids can precisely view objects such as flowers and leaves. The optical polished biconvex glass lens is available in 3 different designs: choose between a 5 times, 7 times or 10 times enlargement. The colourful plastic frame is also ideal for small children hands. Delivery in assorted colours. Diameter of magnifier: 2.5 cm, Length: 7 cm  
All Warning Notice: 2 (page 271)

**6599V90** 5x Magnifying Glass

**6592V90** 7x Magnifying Glass

**6593V90** 10x Magnifying Glass



### Magnifier with handle

The large visual field and the easy handling of the 15 cm long magnifying glass enables younger children to observe flowers, leaves, buds and other objects. Diameter of magnifier: 5 cm, Length: 15 cm  
3x enlargement  
Warning Notice: 2 (page 271)

**9993V90**



Minimum order: € 400,-



**Stereo Microscope**

- See life in 3D
- › Comfortable viewing with both eyes
- › Eye distance is adjustable
- › 20x magnification
- › Built in LED light illuminates any specimen
- › Real optical glass lenses provide clear 3D image
- › Portable battery power  
(uses 2x type AA Mignon LR6 batteries – not included)
- › Reversible black & white stage plate provides contrast
- › Includes vinyl dust cover

**86486V90**



**Big Magnifier**

Perfect for magnifying insects and everything else that fascinates children.

2x magnifier, length: 23 cm, Diameter: 8 cm

Warning Notice: 2 (page 271)

**85803V90**



**Prepared Micro-Slides**

12 Slides with 36 assorted specimens (beverage samples, plastic, synthetic fibres, grasshopper, medicine, starch, micro-film, natural fibres, animal, algae, vitamin and fungi)

**85797V90**



**All-Purpose Thermometer**

This all-purpose thermometer has a temperature range of -30 °C to +110 °C.

It comes in a case that magnifies the scale to make it easier to read. The case may be hung up or positioned to keep the thermometer at an angle. Six sliders allow high and low temperatures to be recorded. The thermometer may be easily removed from the case. Made of plastic.

Dimensions: Stick thermometer Dia.

6 x 300 mm

Main body (H x W x D): 32.5 x 3.7 x 2 cm

Warning Notice: 41 (page 271)

**83304V90**



**Dissecting Kit**

Stainless steel tweezers, needle, spatula, stirring rod, scalpel, scissors and dropper. Scalpel: 14.5 cm

Warning Notice: 2 (page 271)

**6529V90**



## TRANSMITTED LIGHT

### LED Microscope for Beginners

Children learn how to use a microscope. It's a basic biological microscope to look at specimens on a slide (light shining up from under the slide and through the tissue). It can also be used as a dissecting microscope to view objects at lower power (light shining down onto the specimen to be observed). This new scope allows for both types of applications. Cordless battery power makes it portable for field study.



## ... AND INCIDENT LIGHT

### Content:

- > 5 plain slides
- > 1 concavity slide
- > 4 prepared slides
- > cover glass
- > plastic dropper
- > 2 bottles of stain
- > slide labels
- > lens paper
- > forceps
- > plastic test tube
- > plastic petri dish
- > straight teasing needle
- > instruction manual

**85908V90**



### Double Lens Bug Viewer with Screw Top

Lenses: Diameter: 4.5 and 3 cm. Magnifying size: 2x and 4x

With built-in air holes and measuring grid.

Warning Notice: 1 (page 271)

**6639V90**



### Telescope Double Lens Bug

Viewer with Screw Top

Lenses: Diameter: 4.5 and 3 cm.

Magnifying size: 2x and 4x

The lid has air holes to let bugs breathe while being examined. To get a closer look at all kind of tiny things such as bugs, flowers, coins ...

Warning Notice: 1 (page 271)

**85143V90**



### Buzzing Studio

Hear what insects have to say to each other with the bug buzzing studio. This bug viewer with earphone is intended to help students use their listening skills to make observations of their environment.

With magnifying lens 2x and earphone.

Height: 9 cm

Batteries not included.

Warning Notices: 1, 4 (page 271)

**52111V90**



**NEW**

### Jumbo Magnifiers with Stand, set of 6

Each magnifiers super-safe, plastic lens measures 20 cm long with a diameter of 11.5 cm and offers 4.5x magnification

Warning Notice: 1 (page 271)

**759546V90**



### Magnetic Lifecycles

Extensive set for the clear representation of the life cycles of chicken, butterfly, bee, snail and frog.

#### Content:

- › Magnetic board, writable and wipeable
  - › Wall mounting material
  - › Storage for whiteboard markers for fixing to the lower edge of the board
  - › 5 Magnets „From The Egg to the Chicken”
  - › 5 Magnets „From the Spawn to the Frog”
  - › 5 Magnets „From the Egg to the Snail”
  - › 5 Magnets „From the Egg to the Bee”
  - › 5 Magnets „From the Egg to the Butterfly”
  - › 5 magnets for marking or numbering the cycle steps, writable with water-soluble foil pen (not included in scope of delivery)
- Dimensions board (H x W x D): 64 x 94 x 1.3 cm  
Material: foam, magnet

**760320V90** With board

**760310V90** Without board



## LITTLE SCIENTISTS MAKE INCREDIBLE DISCOVERIES



### Class Set of 24 Box Magnifiers in Case

The sturdy case facilitates transport and protects the magnifiers from moisture and dust.

Dimensions:

Magnifier: 3.8 x 3.8 x 3.8 cm

Case: 8.1 x 27 x 24.6 cm

Warning Notice: 2 (page 271)

**86186V90**



### Plastic Vivarium

Plastic cover contains built-in lid.

Also valuable for many activities with liquids. For example floating and sinking or comparing absorbency.

Dimensions (H x W x D): 19.4 x 29.3 x 17.5 cm

**86375V90**

# EASY LEARNING WITH COLOURS

## Colour Microscope

### The microscope for colour-supported learning!

With it children learn the correct handling with microscopes. Due to the different coloured parts, the different functions are easier to distinguish. The names of the important parts of the microscope become more readily apparent to the microscopy students.

Simply switch from incident light to transmitted light: The design is modern and appeals to children.

It makes you curious and encourages young researchers to learn how to do the microscopy. When explaining and naming the individual microscope parts can be conveniently resorted to the colours.

The microscope combines professional microscopy with child-friendly design. The handling is very easy.

The learning microscope has no annoying cables and works with battery power. Required are 3 batteries type AA, Mignon LR6, not included!

### Technical specifications:

- › Magnification: 40x, 100x, 400x
- › Eyepiece: 10x wide field
- › Lens: 4x, 10x, 40x
- › Illumination: incident and transmitted light, each with one LED

**757943V90**



# BLOCKS OF LIFE

**MAGNETIC**

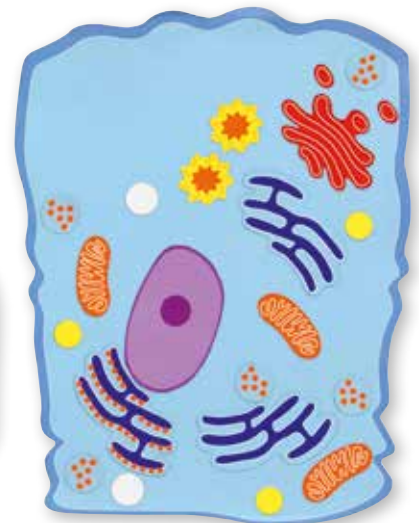
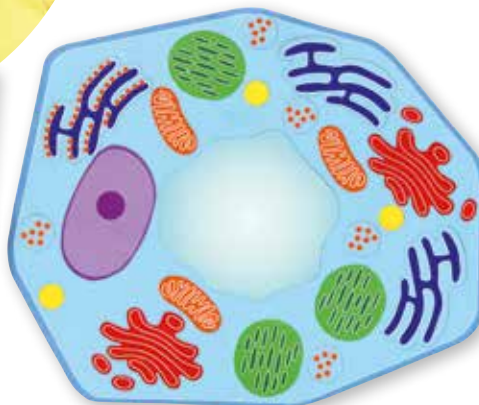

## GIANT MAGNETIC CELL

Easy to apply on your blackboard

The cell is the basic unit of life and all organisms are made up of cells. Let's discover all parts and the corresponding terms with this giant and appealing version. Step by step the cell can be assembled at the board.

Minimum order: € 400,-

### Giant Magnetic Plant Cell

Includes 43 parts: 26 magnetic cell parts, 13 magnetic term tags (one side English, the other side German), 4 worksheets (German/English).  
Dimensions of the cell (W x H): approx. 54 x 65 cm

**89750V90**

### Giant Magnetic Animal Cell

Includes 42 parts: 26 magnetic cell parts, 12 magnetic term tags (one side English, the other side German), 4 copy worksheets (German/English), dimensions of the cell (W x H): approx. 50 x 65 cm

**89749V90**



**NEW**

**Layer Puzzle: Pregnancy**

Four layers, 28 pieces  
 Dimensions (H x W x D): 2.2 x 30 x 18 cm  
**761586V90**

**Layer Puzzle**

Layer puzzles promote the ability to concentrate, combine and imagine. Children gain insights into different developmental stages or into the inner structure of boys or girls.

- › Attractive, lovingly detailed presentations offer opportunities for conversation. Finding the right names for the puzzles.
- › Naming the development steps
- › Discuss time schedules. How much time has passed between the individual stages?

Each puzzle consists of five development steps or four layer puzzles. The first picture (first development step) is printed in the bottom of the puzzle frame. On the puzzle frame, there is an overview of all development steps on the top right.

The individual layers of the jigsaw puzzles can also be puzzled next to each other on the table, so that a direct comparison is visible, or the differences or developmental steps become clear.



**NEW**

**Layer Puzzle: Anatomy of Girls**

Four layers, 27 pieces  
 Dimensions (H x W x D): 2.2 x 30 x 18 cm  
**761583V90**



**NEW**

**Layer Puzzle: Anatomy of Boys**

Four layers, 27 pieces  
 Dimensions (H x W x D): 2.2 x 30 x 18 cm  
**761582V90**



**NEW**

**Layer Puzzle: Lifecycle of a Girl**

Four layers, 28 pieces  
 Dimensions (H x W x D): 2.2 x 30 x 18 cm  
**761585V90**



**NEW**

**Layer Puzzle: Lifecycle of a Boy**

Four layers, 28 pieces  
 Dimensions (H x W x D): 2.2 x 30 x 18 cm  
**761584V90**

## Discovery Kit "Eyesight"

- › How does the eye function?
- › Exciting experiments
- › For station learning

Why do some people need eyeglasses? What happens when looking into the distance and why is the picture projected onto our retina upside down? Students can answer these questions with the help of different experiments and exercises. Through these experiments, every student can understand how eyesight functions. For 4th grade and higher

### Content:

7x optical lenses, 1x LED-spotlight, 4x worksheets, 1x manual  
Warning Notices: 2, 34 (page 271)

**89947V90**



## Giant Eye Model

Highly detailed eye model. Dissectible into 6 parts: top section, vitreous body, bottom section, lens, iris, cornea. Mounted on a stand. Dimensions: diameter: 16 cm, height: 21 cm

**86192V90**

## Set of 7 Optical Models

The lenses and prisms enable students to study reflection and refraction of the light. They are made of flawless acrylic glass.

### Dimensions:

smallest model: 2.3 x 3.8 cm

biggest model: 2.3 x 7.5 cm

Warning Notice: 34 (page 271)

**83332V90** In storage box



REFRACTION WITH BEAM



EXPERIMENTS FOR LIGHT REFLECTION



DIFFERENT COLOUR MIXTURE

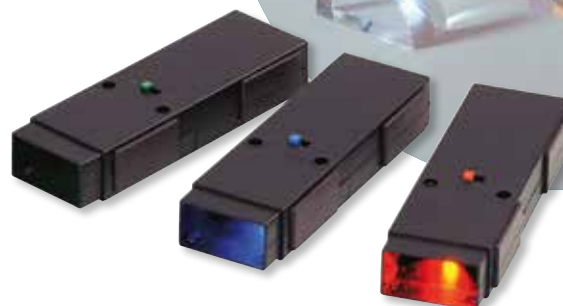

## LED-Colour Projectors

The special flashlight produces either a light cone or a linear light beam.

Examples of use for linear light beam:

- › With optical lenses you can demonstrate the refraction of light.
- › Arc measurement of light refraction.
- › With convex or concave prisms you can demonstrate visual defects of the eyes.
- › With a hand mirror your students can divert and re-route the rays.

Examples of use for light cone:

- › Ideal for all colour mixture experiments.

- › Combined with prisms you can demonstrate the principle of light refraction.
- › Using a combination of all light cones you can show the principle of additive colour mixtures.

Each projector is magnetised. Therefore experiments can be performed on either the blackboard or working place. Presentation: 3 LED-colour projectors (each 1x red, green, blue).

The pictured mirror, prism and working sheets are not included in delivery.

Dimensions (H x W x D): 3.5 x 2 x 11.5 cm

Warning Notices: 1, 2 (page 271)

**83300V90**

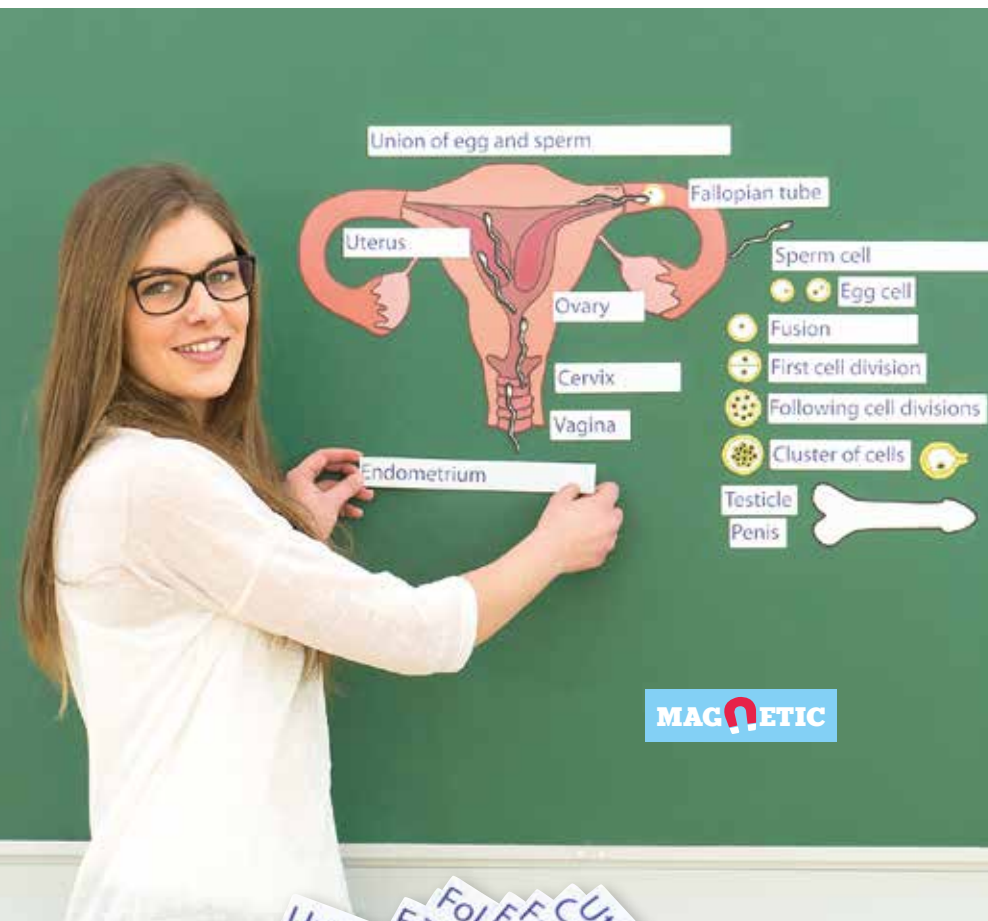

### Human Reproduction

Children are curious about how life begins. Now you can demonstrate how and where life develops on the black board. Explain the terms ovulation, fertilisation, uterus, penis, sperm cells etc. objective and factual. For bilingual lessons (English/German) you can use the backside of the magnetic name cards.

Suggestions how to organise complete school lessons can be found in the handout.

The copy templates (working and answer sheets) are designed in 3 different levels in German and in English. Contains 37 pieces: 21 magnetic pictures, 15 magnetic name cards (German/English), 1 handout with copy templates.

Dimensions of uterus: approx. 47 x 29,5 cm

89846V90

HOW DOES LIFE  
COME ABOUT?

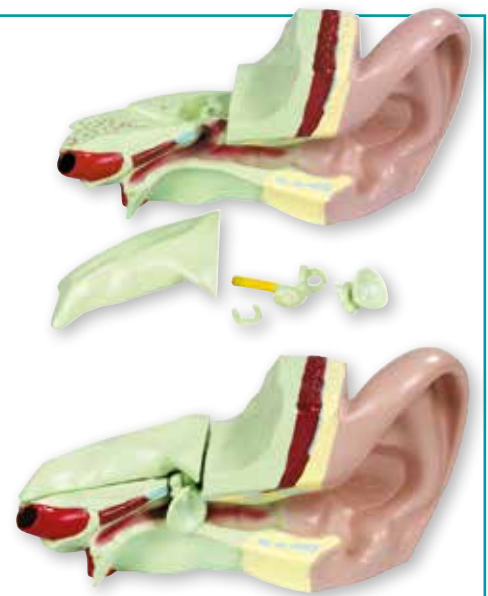

### Giant Ear Model

A giant model of the ear, for elementary science classes. Shows all major structures related to hearing and balance. Features a removable bone section to reveal the auditory ossicles with eardrum and labyrinth.

Dimensions: 14 x 44 x 28 cm

86376V90



### Stethoscope

Children can hear their own heartbeat using a stethoscope. For classroom use.

Warning Notice: 1 (page 271)

85754V90







**The Miracle of Life – a Fascinating Journey**

Show the 9 stages of development inside the uterus. Pillow-like cloth fetuses represent the average size and weight of a fetus during pregnancy. The sachets can be filled with rice (not included). An accompanying cloth wrap can be used to 'wear' these fascinating teaching aids. The students' inhibitions to talk about pregnancy, childbirth and their own bodies can be reduced effectively while holding and feeling the pillow-like fetuses.

**Content:**

- > 10 sachets (6.5 x 4.5 cm to 33.5 x 25 cm)
- > 1 cloth wrap
- > 1 folder with master copies/worksheets (2 levels of difficulty)

Material: 100% polyester, machine washable at 30 °C, delicate cycle

**89847V90**



**Human Skin – Magnetic Materials**

Large, colourful & easy to understand! Show the different layers of the human skin and gradually build the model on the chalkboard. Depending on the grade you are teaching and the pupils' performance level you can arrange the model very simple or very demanding. The word cards, worksheets or master copies in English and German can be used for bilingual teaching. Materials come in two levels of difficulty.

**Content:**

- > 13 magnetic skin parts
- > 17 magnetic word cards (double-sided, English/German)
- > 1 folder with master copies/worksheets

Dimensions: 60 x 32 cm

**754463V90**

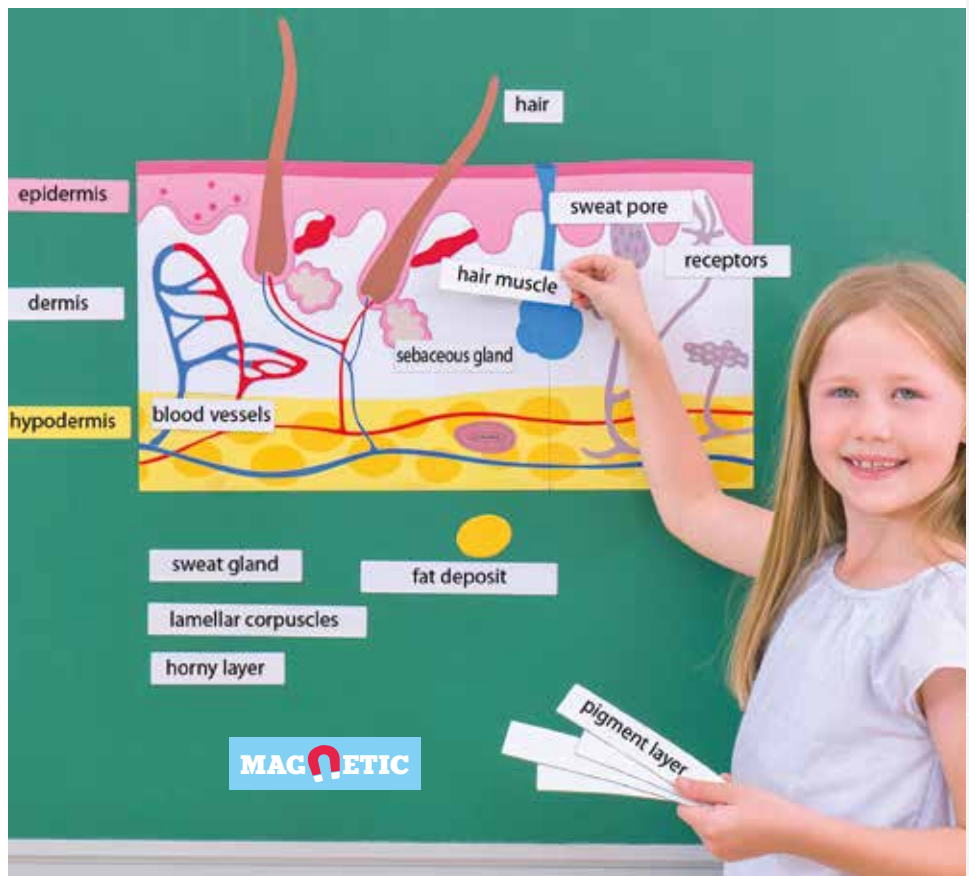

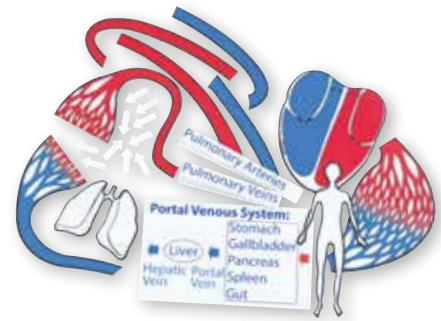

### The Circulatory System

How does blood flow, where are the heart valves located and what are veins, arterioles and capillaries? Explain the pulmonary and systemic circulation to your students in a relevant and memorable way. The complete circulatory system can be presented step by step on the blackboard.

For better explanation, pulmonary and systemic circulation system can be presented consecutively. Depending on grade and performance level, the circulatory system can be explained in different stages. Use the English name tags for bilingual lessons (English). The enclosed manual with copy templates is also in English. 18 piece circulatory system, 15 name tags printed on both sides (German/English), 1 tag for portal system, 1 manual with copy templates in 3 levels, for 3rd grade and up  
Model full size: approx. 77 x 35 cm

**89946V90**

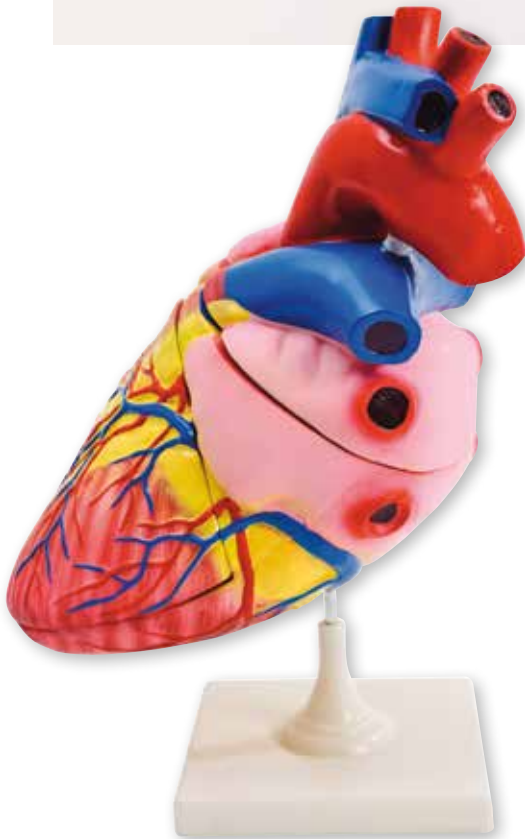

### Giant Heart Model

Detailed model of the heart at approx. 4 times life size. Dissectible into 3 parts. Mounted on demonstration stand.

Dimensions: ca. 28 x 28 cm

**86178V90**

### Heart Model

Life sized heart model made of durable ABS. With detachable cover piece and valves. Realistic presentation.

Dimensions (H x W x D): 7 x 12 x 8 cm

**85796V90**

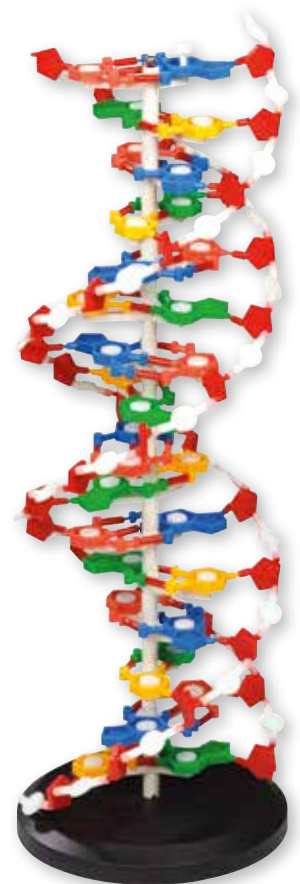

### Large DNA Model

Ideal to demonstrate the structure of the DNA. The double helix is clearly visible. The make-up of the base pairs is also shown. The hydrogen bonds between the bases are shown as links. Adenine and thymine are shown with two links, guanine and cytosine with three links. Easy disassembling to demonstrate the structure and individual parts.

Bases, desoxyribose molecules and phosphodiester bond individually dismantlable. Dismountable

Height: approx. 60 cm, diameter: approx. 20 cm

**86176V90**

# OUR BODY

**BEST  
SELLER**



## Torso

Accurate yet uncomplicating details make this model an ideal replica of the human body. Made of durable plastic. Anatomically correct. Sexless human torso.

Height: 50 cm

11 parts, allowing the study of different organs. The head can be dissected in 2 parts.

**85138V90**



## Mini Torso

How does our inside look like? How does a human body work? Children are interested in those kinds of questions and here they can find a lot of answers by examining the torso.

Detachable organs: lungs, heart, liver, stomach and intestine. Subjacent organs, brain and musculature are clearly visible. Height: 27 cm

**81895V90**



## Small Skeleton

This skeleton is great for students to learn the components and structure of the human skeleton.

Mounted on demonstration stand.

Height: 80 cm

**86188V90**

## Mitosis Model

Your students learn the process of cell division of a herbal cell and of an animal cell. One model shows the nuclear division of the herbal cell and the other model of the animal cell. The following applies to both models: All 6 stages (interphase, prophase, metaphase, anaphase and telophase) are demonstrated.

Each model consists of one base plate and 6 single individual removable parts. The herbal and animal model differentiate by different forms.

**86173V90**



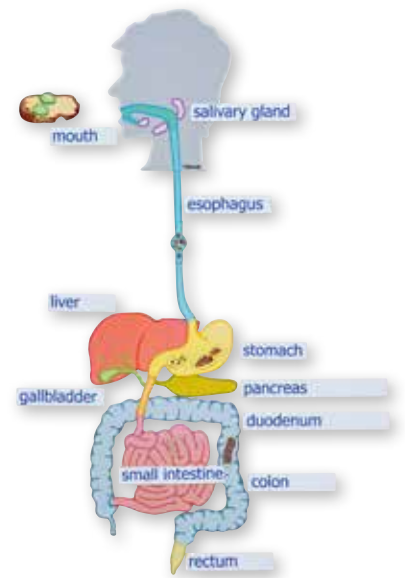
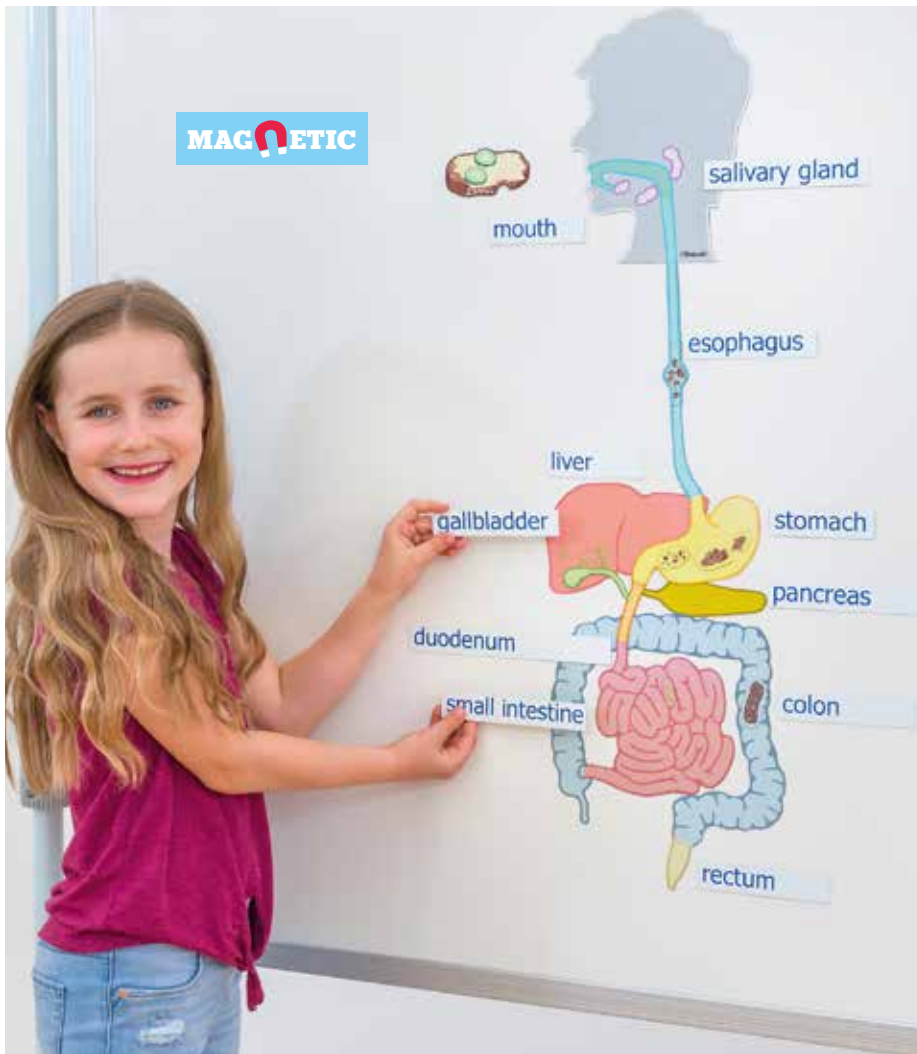

### Human Digestion

The human digestion can demonstratively be explained with these magnetic digestive organs. It is clearly visible where the different organs are located in the human body and how they work. Moreover, the set includes some magnetic pictures of food. Therefore, the children can follow a piece of bread with butter, cheese or cucumber on their way through the human body. Additionally, the set includes an adequate tale (for reading or as cloze in 2 different levels of difficulty).

#### Content:

- > 18 magnetic pictures (size of the head: ca. 23 x 18 cm)
  - > 11 two-sided printed name badges (German/English)
  - > 1 supplement with copy templates
- Height: 80.5 cm  
Width: 22.5 cm

**757882V90**

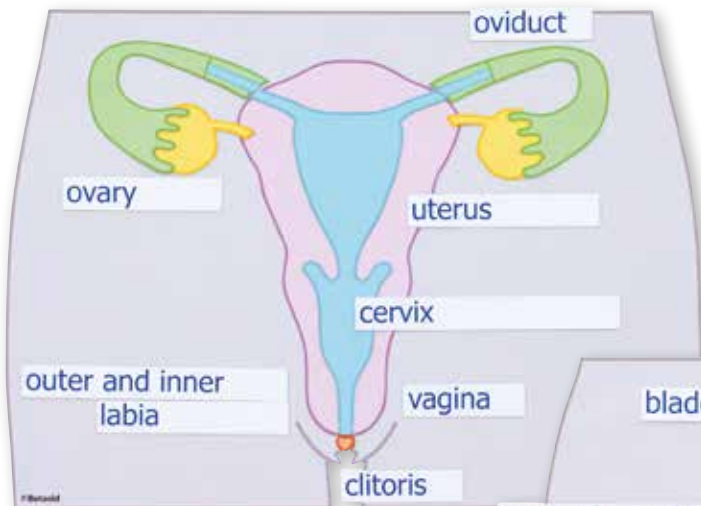

# GENDER ORGANS

**MAGNETIC**

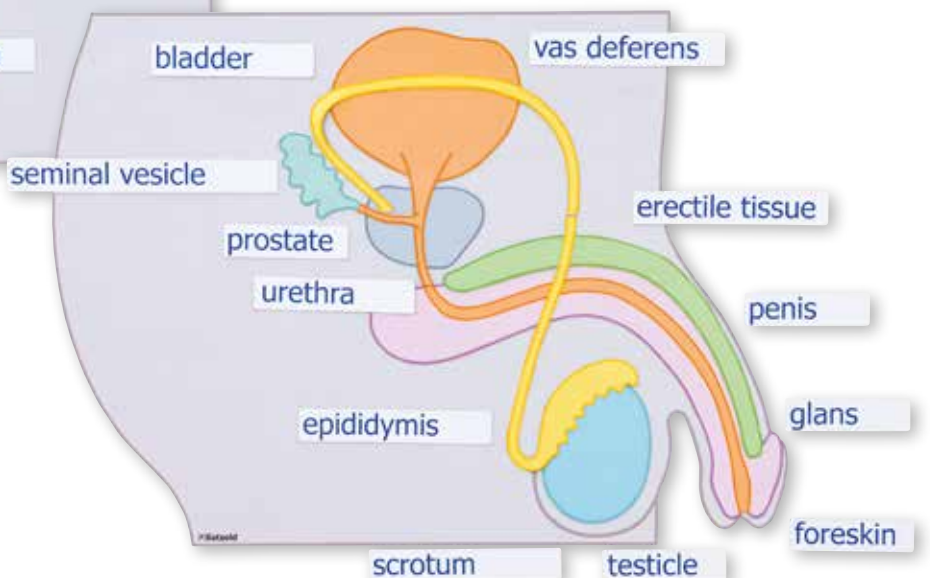

### The Genital Organs, magnetic board material

This item enables to teach and show this sensitive subject in an objective but interesting way. Fix the parts step by step on the board and tell children about the sexual parts and their function.

8 magnetic female parts (grey body part: 39 x 55 cm),  
9 magnetic male parts (grey body part 42 x 57 cm),  
38 magnetic word plates (English, French and German),  
1 manual with copy sheets (2 levels) included

**758182V90**



### Toothbrush Demonstration Kit

To teach children proper oral care. Teeth are connected to large flexible wire allowing the giant toothbrush to access the hard-to-reach areas.

Toothbrush: 36 cm long, Dimensions: Dental Model: 10.5 x 23 x 16.5 cm

**2038V90**



### Dental Model

Realistic shapes and details

Dimensions (H x W x D): 9 x 7 x 11 cm

**85456V90**



### Colour Mixing Strips

Transparent strips in 6 different colours. Help children understand the basic colour theory.

Warning Notice: 1 (page 271)

**81840V90**



### Mortar and Pestle, 320 ml

Great for pupils to grind and study different food items

Diameter: 13 cm, filling capacity: 320 ml

**754510V90**

### Mortar and Pestle, 50 ml

Diameter: 6 cm, filling capacity: 50 ml

**74727V90**

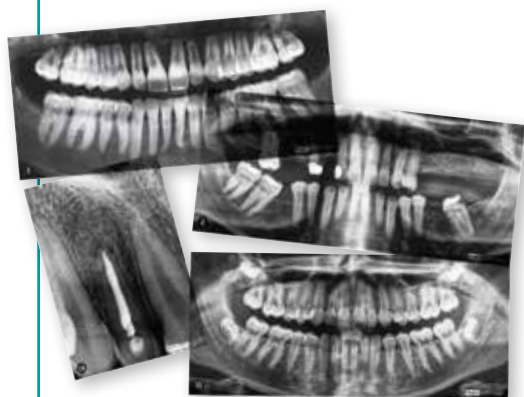

### Dental X-Rays

Brushing and flossing teeth is important, but our x-ray set goes beyond the basics. Give students an exclusive look at the consequences of tooth injuries and infections of all kinds. Explore the development of healthy teeth and the intricacies of correcting growing teeth with braces.

**Content:** 10x-rays and guide

**757316V90**



### Human X-Rays

These genuine images of the human skeletal system can be placed on light panels, or held up to a lamp or overhead light, to see bones as only x-ray technology can allow. Arrange the pieces to create a complete skeleton.

**Content:** 18 x-rays, reproducible worksheets and guide

**50928V90**



### Life-sized Skeleton Model

Life-sized skeleton model with detailed bone structure to help demonstrate the nuances of the human skeletal system. Great for students to learn the components and structure of the human skeleton. Height: 170 cm

**86924V90**

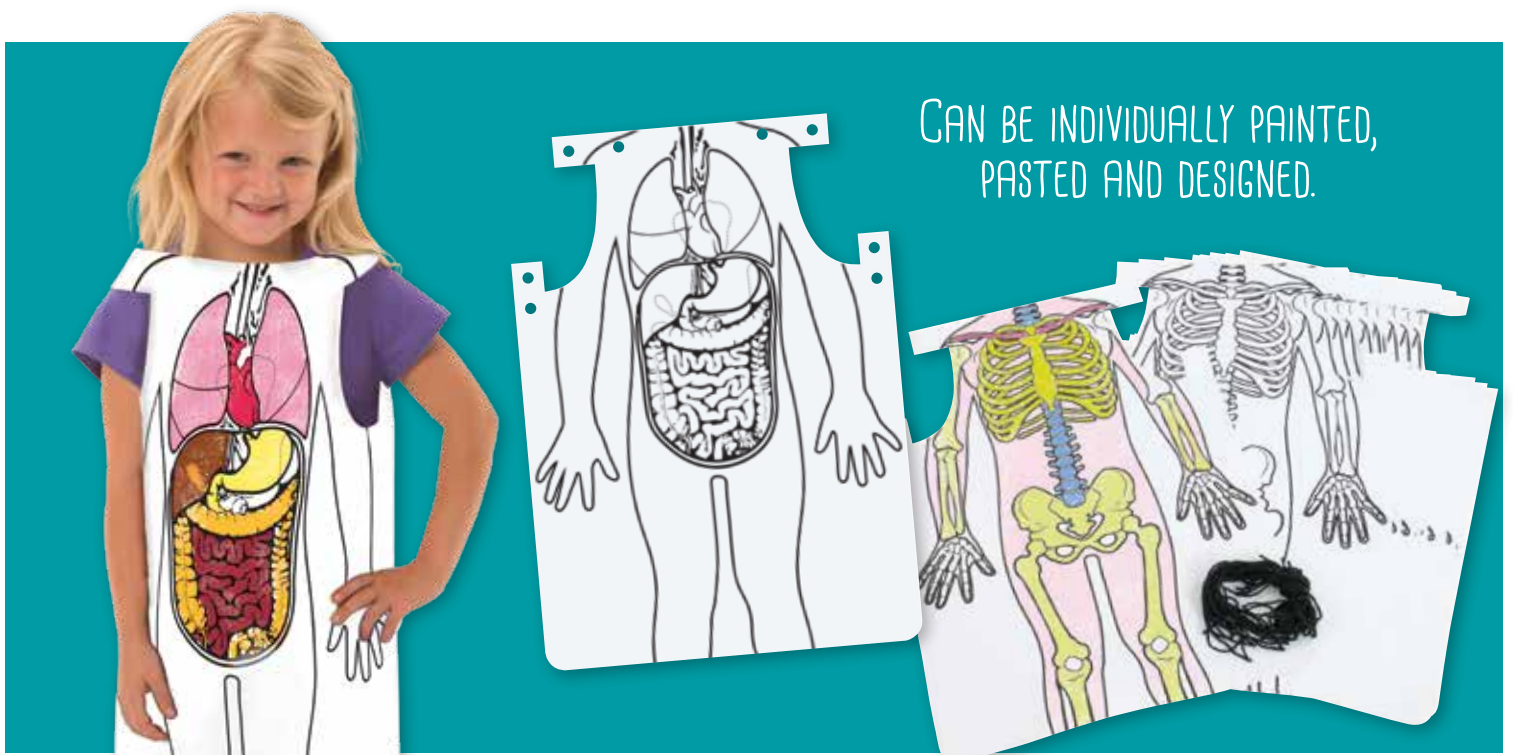

CAN BE INDIVIDUALLY PAINTED,  
PASTED AND DESIGNED.

### Personalised Apron with Organ Motive

The apron is made of high-quality and durable paper which can be individually painted, pasted and designed. After the apron has been designed, it can be tied together with the included laces and given holes and worn by the children. By painting and designing the apron, the children get to know the makeup of the human body. All important organs like lungs, heart, gullet, liver, stomach, spleen, gall bladder and large and small intestine are printed on the apron.

**Content:** 12 aprons, dimensions (L x W): 67 x 47 cm  
Warning Notice: 4 (page 271)  
**757309V90**

### Personalised Apron with Skeleton Motive

The apron is made of high-quality and durable paper which can be individually painted, pasted and designed. After the apron has been designed, it can be tied together with the included laces and given holes and worn by the children. By painting and designing the apron, the children get to know the anatomical bone structure of humans and interesting functions of the body.

**Content:** 12 aprons, dimensions (L x W): 67 x 47 cm  
Warning Notice: 4 (page 271)  
**757310V90**

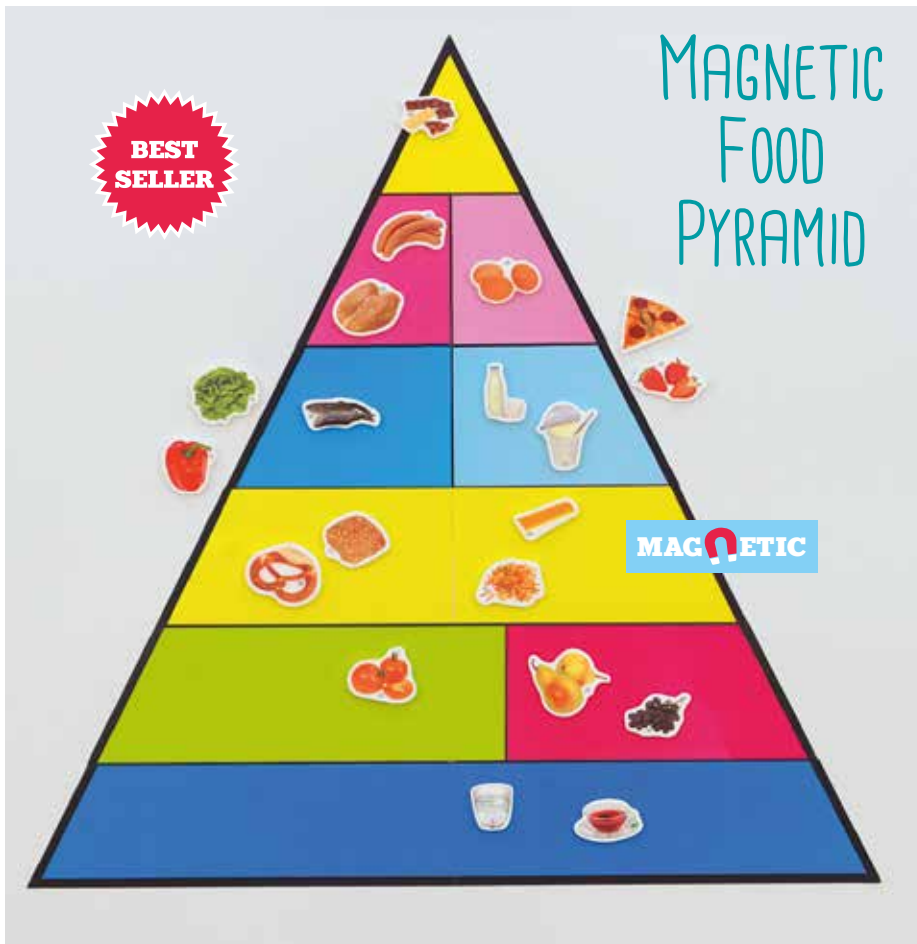

### Magnetic Pictures to Create a Food Pyramid

A balanced diet is very important for the children in today's hectic schedule. But what is healthy and what is unhealthy? There is much to find out about our food. The magnetic pictures help to sort and visualise what we should eat and what we should avoid.

Size: up to 9 cm, in sturdy cardboard box  
**88614V90** Set of 50 pieces

### Magnetic Food Pyramid

This pyramid consists of 9 pieces. Can be used together with magnetic food pictures.

Dimensions: 90 x 90 cm  
**88107V90**

**SET: Magnetic Food Pyramid + 50 Magnetic Pictures**

**70825V90**

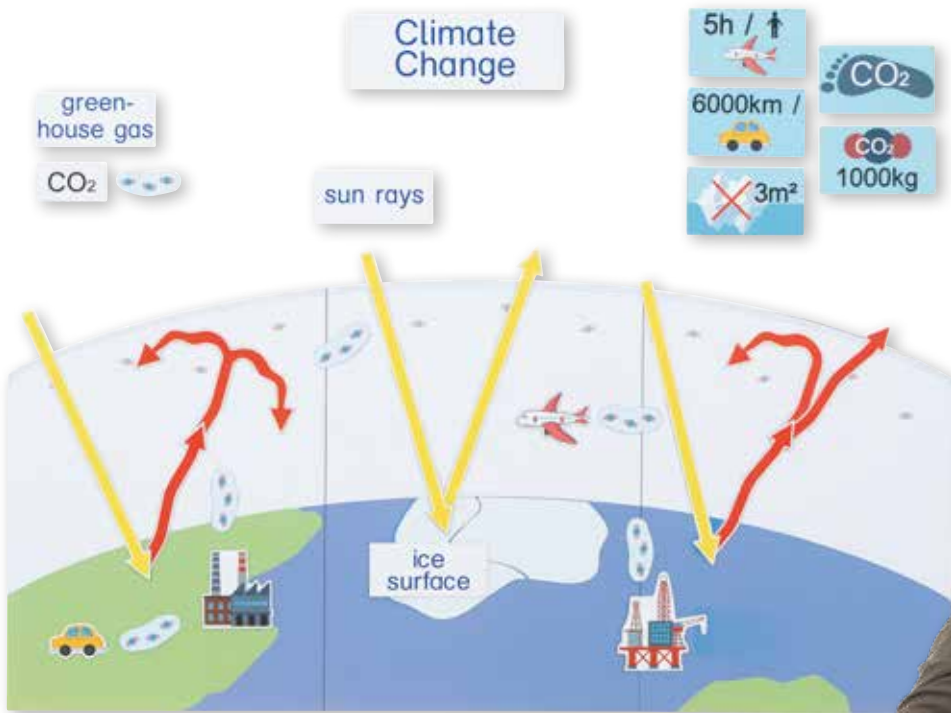

**Climate Change – Magnetic Board Material**

CO<sub>2</sub>-caused climate change, board material  
 This set contains magnetic board material that helps to explain the climate change in a comprehensible way.

**Content:**

38 magnetic parts for the board (with word cards in German, English and French)  
 Measurements (H x W x D): 1.9 x 38.5 x 57.9 cm

**759818V90**



**I'm planning my experiment – Magnetic Board Material**

This item allows to develop an experiment's process directly on the board. Students learn how to express the question and make a supposition. They find out how to plan an experiment, watch, describe and evaluate. And last but not least the magnetic table signs remind them to tidy up and dispose the waste.

**Content:**

29 table plates (9 coloured illustration signs – 20 x 16 cm each. 20 word plates: English, French and German – 20 x 5.5 cm each), 1 worksheet to copy

**760405V90**

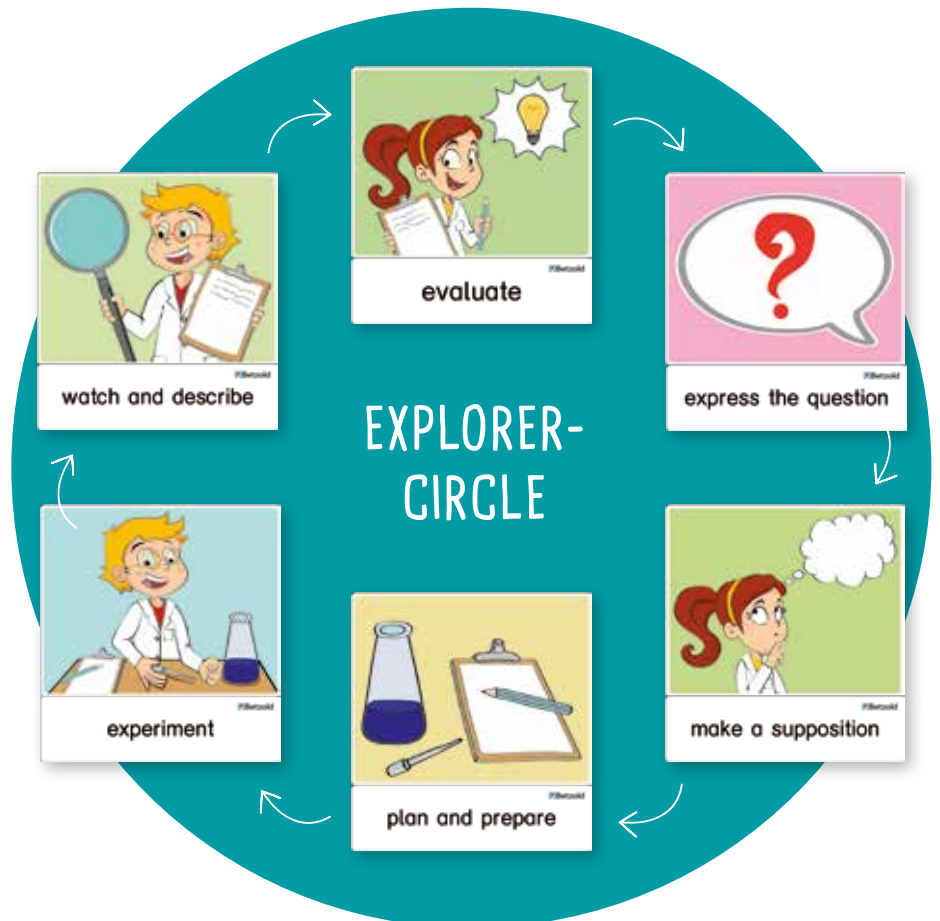

**NEW**



## AROUND THE WORLD



### **Carpet "The animals of our world"**

Made from 100% nylon, bottom made from 100% latex  
With pictures of cities, continents, climate zones and  
animal's habitats.

Size (H x W x D): 1.5 x 300 x 200 cm

**761207V90**

### **Writeable Globe, only borders**

The white surface shows the outlined countries. Colour  
them with erase markers and write the names of conti-  
nents or countries on the globe.

#### **Content:**

Globe: diameter: ca. 28 cm

4 dry wipe markers, 12 reusable animal stickers

**86777V90**

### **Solar System**

With an illuminated sun, 9 planets including  
Mercury, Venus, Earth, Mars, Jupiter, Saturn, Uranus,  
Neptune and Pluto as a dwarf planet. It rotates automa-  
tically and has an interactive voice (English).

Batteries are not included.

Warning Notices: 1, 5 (page 271)

**85800V90**





### Magnetic Water Cycle

Large magnetic water cycle for black or white boards with key words related to the water cycle. Great for explaining what the water cycle is and how it works. The children identify major stages of the water cycle and use the model to demonstrate their knowledge. Furthermore, they develop scientific vocabulary.

**Content:** 6 symbols (land, water, sun, 3 clouds, rain and snow), 5 arrows, 14 term tags  
Made out of magnetic foil

**89853V90**

**MAGNETIC**

### Water Cycle Simulator

Where does the rain come from? Why do rivers flow? Demonstrate nature's water cycle: Fill water into the sea and put some ice cubes into the cloud. Use a desk lamp as sun – and see what happens. The sun evaporates the seawater. The ascending vapour condenses at the cold cloud. It starts to rain. The rivers collect the rain water and transport it back into the sea. The cycle is closed.

**Content:** relief basin, lid, cover for the cloud, stand (lamp is not included)

Dimensions (H x W x D): 12 x 51 x 31 cm

**86618V90**

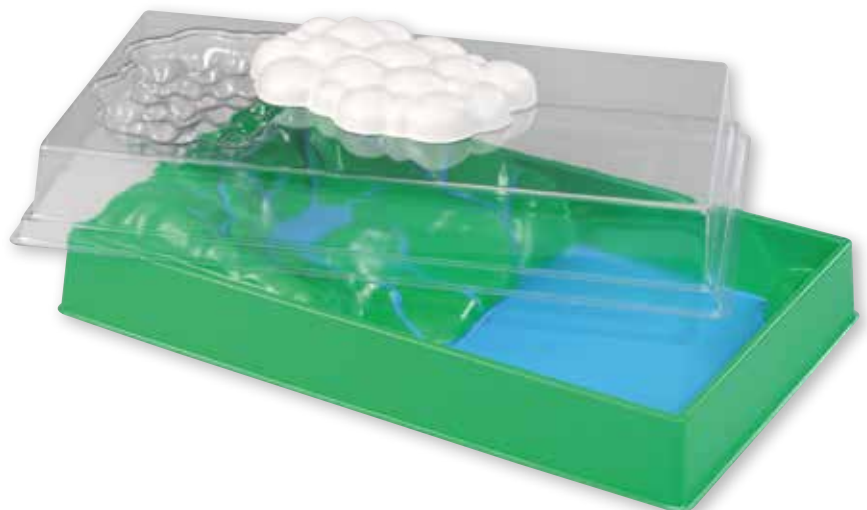

### Weather Stamp Set

Stamp the real weather on a given day or what the children would like it to be! Learn about the changing weather patterns. Great for use on weather charts and calendars.

Diameter: 7.5 cm

Warning Notice: 1 (page 271)

**54020V90** Set of 12 stamps

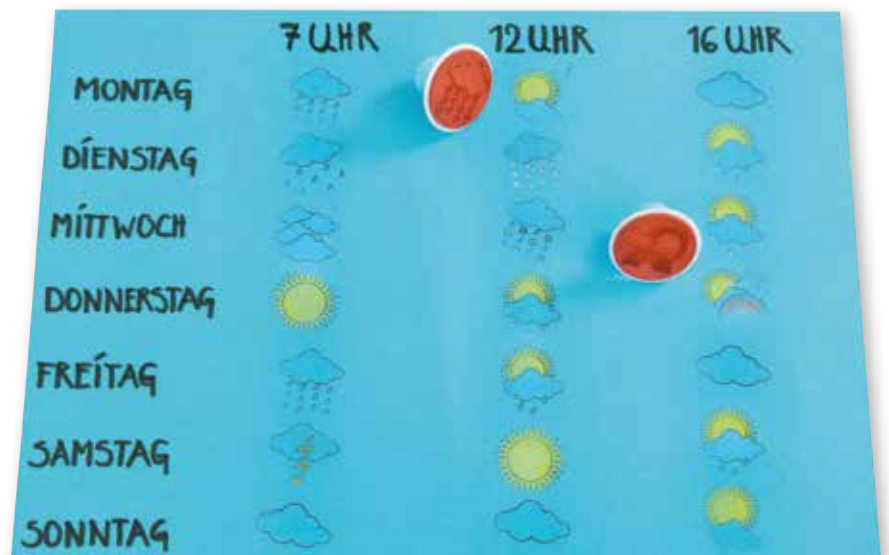

Minimum order: € 400,-



WITH SOLAR MODUL!

### Construction Kit Electric Current

The electric current kit for primary schools helps children to learn about electricity. They build simple electrical circuits, simple switches, investigate the electrical conductivity of materials and so on.

56 construction parts, detailed manual with lots of sample applications. Dimensions (H x W x D): 4 x 47 x 34 cm  
Warning Notices: 1, 2 (page 271)

81937V90

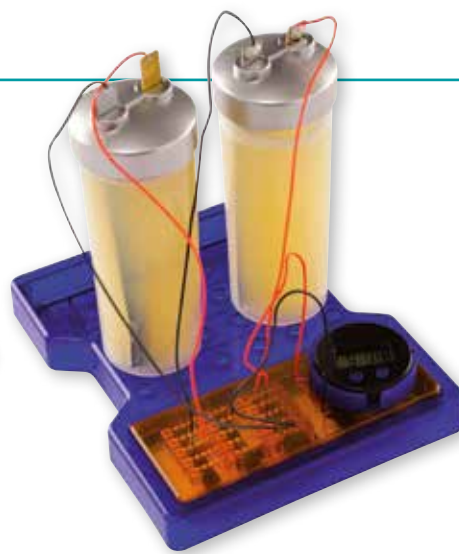
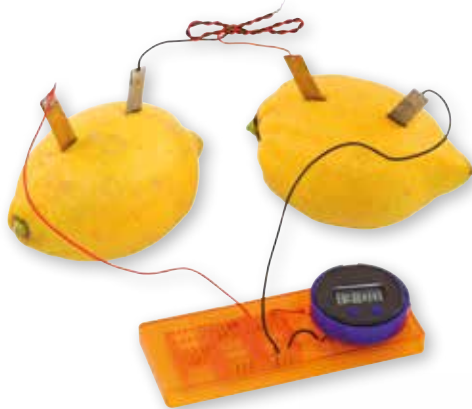

### Lime Clock

In this science project children learn the functionality of batteries with the lime clock. Simply add a lemon, a potato, lemon juice or even cola to generate enough electricity to run a digital clock.

#### Content:

5x wire contact plates, 1x clock module, 1x large base, 1x small base, 1x clock module base, 2x water columns with lids, 2x zinc electrodes, 2x copper electrodes  
Warning Notice: 2 (page 271)

83673V90



### Box with Electrical Materials

#### Content:

10 solar cells SM330, 10 solar motors RF-300, 48 cables with alligator clip, 1 m each, 10 electronic sounder, 30 bulbs 2,5 Volt, 0,3 Ampere, 10 bulb holders, 10 flat square batteries (3R12), 1 transparent storage box  
Warning Notice: 2 (page 271)

83728V90



### Electricity-Kit 1

31 pieces

An ideal introduction to electrical circuits. All basic parts are in plug-in style, easy, safe and quick for practicing electricity skills.

Contains basic electricity parts:

2 bulb holders with bulbs, 2 switches, 1 power pack, 10 wire connectors, 2 battery holders, 4 base plates with 5 connectors, 4 cube connectors, 1 EVA fan, 1 instructions

Warning Notice: 1 (page 271)

85479V90

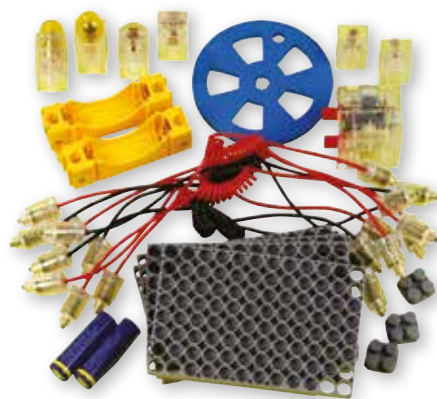
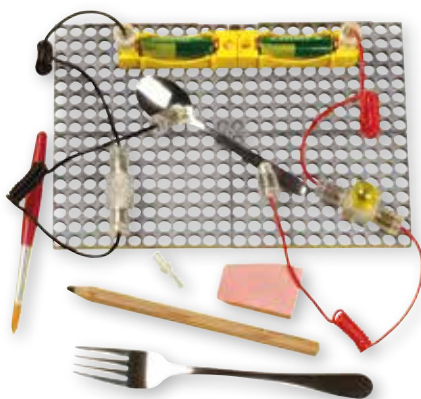



### Discovery Kit Electricity and Circuits

- › Active learning
- › Can be used without grat preparation
- › 7 Fully developed learning stations
- › 48 experiments

Station learning is effective and all children are busy at the same time!

The station box is always ready for use and saves you preparation time! Benefit from the completely elaborated stations and experiments described for children! The entire experimental material is already included.

Your pupils discover the topic of electricity in an action-oriented way. They deal with 48 station cards with the following orders: How do I plan my experiment?

Why is electricity dangerous? Types of switches, series connection, parallel connection, gaps in the circuit, what causes electricity? What does electricity have to do with

magnetism? On the worksheets (copy templates) the children can enter their observations and test results. Detailed explanations, solution sheets and further information are included in the 55-page guideline.

**Content:** Station box with 7 small station boxes  
 41 bulbs, 38 sockets, 96 crocodile hooks, 25 flat batteries, 4 switches, 3m electrical tape, 200 paper clips, 4 propellers, 3 motors, 6 sample clips, 10 sheets of clay drawing paper A4, 30m aluminum foil, 4 clothespins, 1 thermometer made of glass, 1 roll of enameled copper wire, 2 screws, 2 buzzer, 1 manual, 48 station cards, 2 cards 7 mini storage boxes.

Warning Notices: 1, 2, 41 (page 271)

**757790V90**

### Electronic Construction Kit

Build over 350 electronic experiments with this snap circuits kit containing 42 parts. Just snap components together to build one of many projects. Learn about electronics while having fun.

Warning Notices: 1, 2, 32 (page 271)

**89211V90**



42 pieces in sorting box



### Research Case Acoustic

Sounds are created by vibrations. How can sounds be heard? How does sound spread? How can you make sound visible? What is the difference between high and low notes?

**For this purpose, experiments are carried out in these areas:**

- › Experiments on the formation of sound
- › Experiments on how sound travels
- › Experiments on the transmission of tones and sound
- › Experiments on the development of sound and keys

#### Content:

- 30 balloons
- 6 aluminum rulers, 30 cm
- 1 net with 100 marbles
- 2 plastic funnels
- 2 transparent hoses, 12 mm, 1 m long
- 1 roll of cord, 250 g, natural
- 6 teaspoons made of stainless steel
- 10 pipettes
- 1 watercolour box
- 1 brush
- 1 bag of drinking straws, pack of 135, black, 8 mm
- 2 C plastic recorders
- 1 crepe tape, 50 m, 25 mm wide
- 1 comfort seat pad
- 3 tennis balls, approx. 60 g, 60 mm diameter
- 6 plastic bottles, 200 ml
- 1 pressure-sealing bag, 120 x 170 mm
- 1 bag of 150 rubber rings
- 1 instruction/handout

Warning Notices: 4, 5, 6, 9 (page 271)

**83539V90**

### Research Case Mechanics

What is force? Which forces work on us? Can they be measured? How are bridges or buildings built stable? We find out how to save power, how a pulley works and why the Leaning Tower of Pisa does not fall over. Mechanics are also about movement: Why do I fly forward when braking and what causes the stopping at all? Simple and yet smart experiments show what happens in the carousel and how the gearshift works on the bike.

**For this purpose, experiments are carried out in these areas:**

- › Experiments on force and motion
- › Experiments on balance and center of gravity
- › Experiments on dynamics
- › Experiments on friction
- › Power transmission experiments

#### Content:

- 6 dynamometer (spring balance)
- 16 pulleys
- 500 g plasticine, green
- 1 nylon cord on a roll, 50 g
- 25 balloons
- 6 cork plates
- 10 sheets craft felt, 150 g/m<sup>2</sup>
- 6 sheets of sandpaper grit 120
- 10 table tennis balls
- 6 gear translation sets
- 50 giant straws
- 2 balloon pumps
- 1 manual mechanics
- 2 ziplock bags 200 x 300 mm
- 1 zippered bag
- 50 g Alco rubber bands, 150 mm long, 4 mm wide
- 1 comfort seat pad, 320 x 380 x 10 mm
- 1 instruction/handout

Warning Notices: 1, 2, 6 (page 271)

**83543V90**

### Research Case Optics

Light spreads in a straight line. But what happens if it hits surface like a mirror, a white wall, or on water? How do lenses change the paths of light? The most important lens is the one in our eye, how does it work? Where do the colours of the sky come from? Why is there summer and winter? How does day and night come about?

**For this purpose, experiments are carried out in these areas:**

- › Experiments on sunlight
- › Experiments on light absorption
- › Experiments for light reflection
- › Experiments on refraction
- › Experiments on light scattering
- › Experiments on the functioning of the eye

#### Content:

- 50 wooden sticks
- 50 sheets photo cardboard, A4, black 300/m<sup>2</sup>
- 6 mirrors
- 6 double mirrors, 20 x 7 cm
- 1 set crystal hangers, full cut, 18 pieces
- 1 pipette
- 50 microscope slides, unpolished
- 6 magnifiers
- 12 LED lights (red, green, blue)
- 1 set with 7 acrylic prisms
- 1 eye modell
- 2 softball globes
- 1 polystyrene can, 200 x 100 x 85 mm
- 1 pressure-seal bag, 200 x 300 mm
- 3 zip-loc bags
- 1 comfort seat cushion, 320 x 380 x 10 mm
- 6 flashlights with lightbulbs for students
- 1 instruction/handout

Warning Notices: 1, 2, 34 (page 271)

**83540V90**

## Electricity & Electric Circuits

With this set your students perform exciting experiments. They build electric circuits and insert switches in these. They experience how light and heat are generated with electricity. The conductivity of different testing materials are examined by the children. Over 540 parts!



Working material for 16 working groups:

- › 16 electric motors
- › 16 propellers for engines
- › 16 electronic buzzer
- › 16 switches
- › 16 flat batteries 4.5 V (3R12)
- › 16 lock screws
- › 16 thermometers (-10 to + 110 °C)
- › 64 extra-long crocodile cables (1 metre)
- › 32 sockets for bulbs
- › 40 light bulbs
- › 100 paper clips 50 mm
- › 1 coil of copper wire
- › 2 rolls of electrical tape
- › 16 sets of 12 conductivity test materials each, consisting of:
  - metal
  - graphite
  - coal
  - wire
  - plastic
  - wood
  - material
  - glass
- › 1 teacher's handbook with copy templates

Warning Notices: 1, 2 (page 271)

**83675V90**

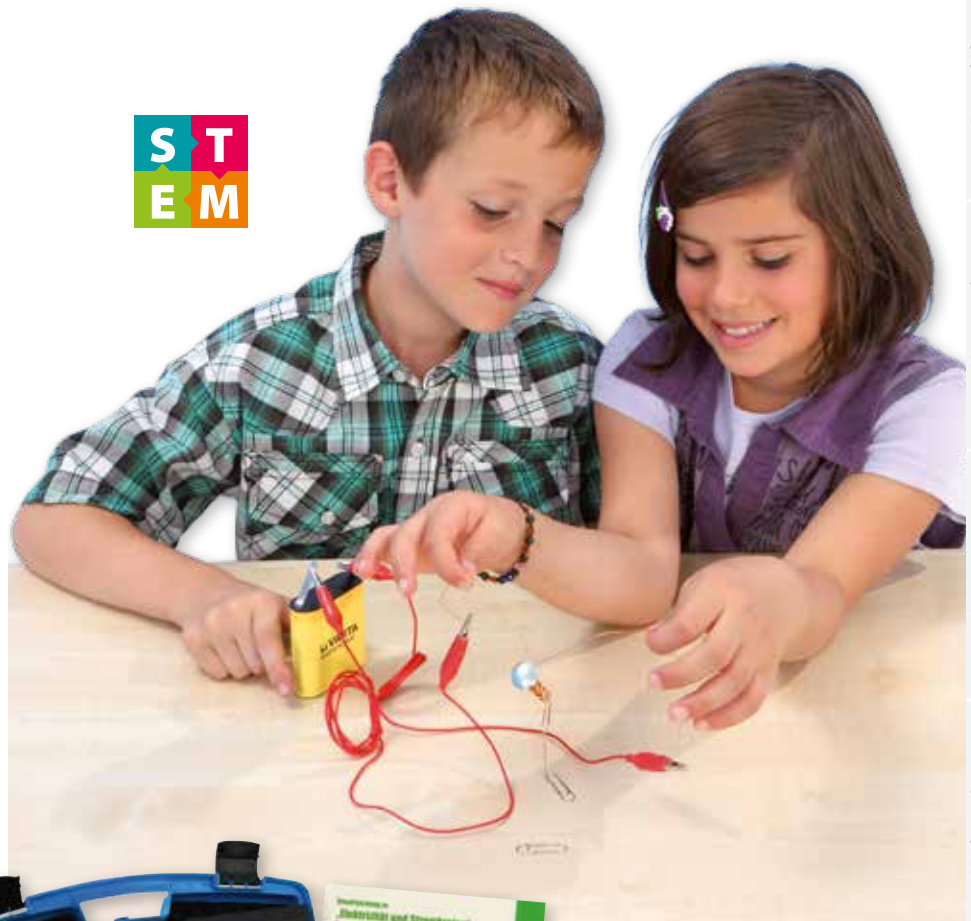

## MATERIAL FOR 16 WORKGROUPS



SERIES AND PARALLEL CIRCUIT



CONDUCTIVITY EXPERIMENTS

## Van-de-Graaff-Generator

This machine produces large static electric sparks for a terrific classroom demonstration. Turning the crank will spin the disks and charge them to a very high voltage. This will be noticeable in several ways including the noise of small sparks between the foil sectors, an ozone smell, and the tingling in your hand caused by the electric field. The cylindrical capacitors aid in producing stronger sparks. No assembly required

Dimensions:  
Platform (W x D): 28 x 18 cm  
Height: 34 cm

**48002V90**



Minimum order: € 400,-



## Alternative Sources of Energy

Children have to learn and know how alternative sources of energy are won and used.

With the contents of this case your students can build small power stations and then operate motor appliances and light sources with it. They understand how these technologies function. They learn the production respectively transformation of energy by means of:

- › water power
- › solar energy
- › motion
- › wind energy
- › electrochemical reaction

Each group studies these different technologies.

The included handout contains copy sheets and background information to this topic.

Working material for 8 working groups with 3–4 pupils each:

8 water turbines, 8 syringes + hoses for the turbines, 8 dynamos / motors, 8 dynamo cranks, 8 wind turbines, 8 solar cells, 8 solar engines, 8 propellers, 8 LEDs, 8 LCD watches, 36 connection cables mounting material, 1 transport case with 3 foam inserts, 1 teacher's handbook with copy templates

A total of 560 parts

Warning Notice: 2 (page 271)

**83674V90**

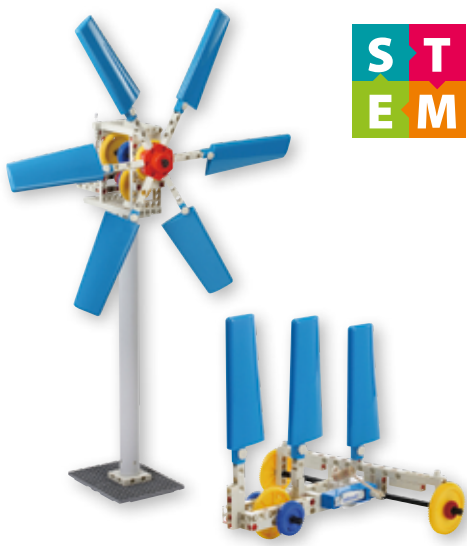

### Wind Power

This kit includes 2 styles of wind turbine blades and a gear box with 3 different gear ratios to fit all wind conditions. The wind turbine blades are adjustable by angle and quantity to make best use of wind in order to make the LED shine bright and charge the battery as fast as possible. The kit helps children to explore the power of wind and stored energy to activate the models they build up.

Includes a 40-page coloured manual with illustrations of 2 wind turbines, 6 model vehicles and various experiments.

Warning Notice: 1 (page 271)

**83931V90** Set of 133 pieces



# GENERATE GREEN ELECTRICITY BY WIND POWER

Pretend Play

Montessori

Language

Mathematics

### Remote-Controlled Robots

Patented "Capacitive Touch Sense" is a novelty for remote control with sound and light effects. 3 different motions can be built with the model at the same time. Comes with 30-times motor, receiver, battery holder and some cool blocks. Develops children's mechanical concepts, independent thinking and eye-hand coordination. This kit includes a 48-page coloured manual and illustrates various amazing models with different mechanical motions to help children learn by having fun.

Warning Notice: 1 (page 271)

**83932V90** Set of 182 pieces



### Senior Solar

With this kit children can explore the applications of solar technology and develop problem solving capacities and creativity. With the multicoloured parts made of plastic, a large double solar cell and an electric motor, stationary and mobile models are created in no time at all.

Includes a coloured manual with detailed instructions for 22 models.

Warning Notice: 1 (page 271)

**83933V90** Set of 265 pieces



Science

Music

Arts & Crafts

Sports & Games

Teacher Resources

Minimum order: € 400,-

**NEW**



**Learning Lab – Explore the Electricity**

Comprehensive set consisting of 211 pieces for 20 models and projects. Helps to explain the phenomenon electricity to children. Age: 7+  
Warning Notice: 1 (page 271)

**761548V90**

**NEW**



**Learning Lab – Explore the Battery**

Comprehensive set consisting of 155 pieces for 16 models and projects. Helps to explain the phenomenon battery to children. Age: 7+  
Warning Notice: 1 (page 271)

**761551V90**



**NEW**

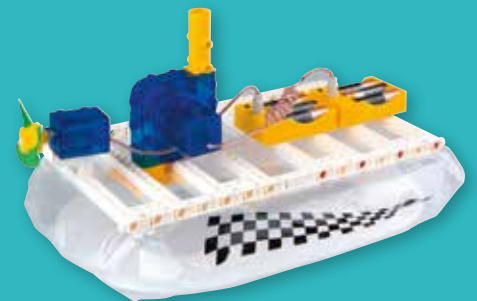

**Learning Lab – Explore the Pneumatics**

Comprehensive set consisting of 143 pieces for 20 models and projects. Helps to explain the phenomenon pneumatics to children. Age: 7+  
Warning Notice: 1 (page 271)

**761549V90**

**NEW**

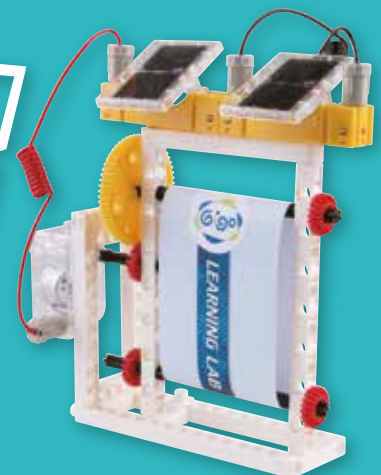

**Learning Lab – Explore the Light and Solar Energy**

Comprehensive set consisting of 169 pieces for 20 models and projects. Helps to explain the phenomenons Light and Solar Energy to children. Age: 7+  
Warning Notice: 1 (page 271)

**761550V90**





**Pulley Set**

For mechanical tests and demonstrations.

**Content:**

- 4x pulley single
- 4x pulley double parallel
- 4x pulley triple parallel
- 6 spring scales (250 g, 500 g, 1000 g, 2000 g, 3000 g, 5000 g)

**83935V90**



**Weight Set with Brass Hooks**

Set of 7 cylindrical masses with hooks.

Set includes the following sizes:

- 1x 10 g, 2x 20 g, 2x 50 g, 2x 200 g (one with hooks on both sides)

**756658V90**



**Vacuum Chamber**

Pump the air out of an airtight container using a hand pump and create a real vacuum.

A variety of experiments can be performed:

- > compare the size of a balloon
- > study the impact on food by placing half an apple inside
- > compare the sound of a ringing mobile phone
- > demonstrate the principle of air resistance by using down feathers

Dimensions of the container: diameter: 12 cm, height: 7 cm

**84731V90**



**ROBOTICS AND HYDRAULICS:  
PHYSICS TO TOUCH - FOR TEACHING AND PROJECT WORK**

**Hydraulic Robotic Arm ▲**

Build this hydraulic machine and use the force of water to grab, lift, turn, push and so on.

Dimensions Cardboard Box (H x W x D):

19 x 25.5 x 5.5 cm

All parts included to build the machines. Detailed manual included.

Warning Notices: 1, 2 (page 271)

**758041V90**

**Hydraulic Machines ▼**

Build this hydraulic machine and use the force of water to grab, lift, turn, push and so on.

Dimensions Cardboard Box (H x W x D): 25 x 31.5 x 7 cm

All parts included to build the 4 machines. Detailed manual included

Warning Notices: 1, 2 (page 271)

Warning Notices: 1, 2 (page 271)

**758039V90**





**Exploring Kit Magnetism**

Observe how magnets influence different materials and other magnets. Learn to set up a configuration following the scheme on the instruction card and discover the basic concepts of magnetism.

**Content:**

- > 5 horseshoe magnets
  - > 4 bar magnets
  - > 6 compasses
  - > 1 set of floating magnets
  - > 1 box with iron filings
  - > 1 weather vane
  - > 10 instruction cards with the assignment on the front and the solution on the back
- Warning Notices: 1, 2, 32 (page 271)

**88416V90**

# COMPASS



**Magnetic Needle on Stand**

Great for studying magnetic phenomena such as the operation of a compass, testing of magnetic poles and finding the direction of electric current. Magnetised steel needle about 7.5 cm long on a non-magnetic metal stand. The north pole is marked in red. Comes with a worksheet.

**86078V90**



**Compass Case**

**Content:**

- 27x mini compasses with compass points (diameter: 2.7 cm)
- 27x mini compasses without compass points (diameter: 2.7 cm)
- 2x magnet needles on stand, (height: 7.5 cm)
- 1x copy sheet wind rose

**81906V90**



**Compass in Metal Case**

Diameter: 5 cm  
 Graduations: 360°  
 Needle is liquid damped to settle quickly.  
 Magnifying lens.

**9982V90**



**Map Compass**

Diameter: 5.5 cm  
 Dimensions (D x W): 90 x 65 mm

**9997V90**



**Compass**

Diameter: 4.8 cm  
 Made of durable plastic. Transparent bottom with lines

**9996V90**

## Discovery Case Magnetism and Compass

The case includes experimentation material on the topics of magnetism and compass. Overall your students are able to perform 28 different experiments. The set includes adequate material for all experiments to be performed at the same time. Therefore, a whole class can work and explore simultaneously.

The enclosed handout for teachers (44 pages) contains interesting information, master copies of each experiment and many solution sheets. The material is stored safely in a robust carrying case with foam inlays and can be easily transported.

Experiments on:

- › Magnets attract, reject or influence each other
- › Magnetic or not
- › Forms, force, effects, patterns, fields, formation of magnets
- › Construction and use of a water- or yarn-compass
- › Big magnet "earth"
- › Electromagnet

### Content:

6 removable big and small storage boxes filled with different big bar- and horseshoe magnets, ring magnets with stands and one electromagnet, metal pads, different magnetic and non-magnetic materials, boxing cars, boxes of iron powder, compasses, jumper wire, magnetic needle with stands and copy templates of a wind rose, sensory perception bag, twine, set square, plastic can. Moreover a ruler and a handout.

Attention: batteries are not included. You need 2 batteries of the type AA.

Warning Notices: 1, 2, 32 (page 271)

**757383V90**



# EXPLORING MAGNETISM



## Magnetism Kit

Fantastic colourful selection of magnetic material for magnetism discovery work.

### Content:

- 1 giant horse shoe magnet
  - 4 magnetic wands
  - 14 magnetic marbles
  - 40 transparent counters with magnet ring
  - 1 horseshoe magnet
- Warning Notices: 1, 5 (page 271)

**87608V90**

## Large Experimental Set Magnets

Children are fascinated by the "invisible force" of magnets.

This kit offers endless possibilities for all kind of magnetic experiments. Ideal for group projects.

Warning Notices: 1, 2, 5 (page 271)

**59323V90**

Minimum order: € 400,-



### Magnetic Attraction Kit

Find out about the first principles of magnetism.

**Content:**

8 ring-shaped magnets (bicoloured), 2 magnetic men (8 cm tall), 2 cars (length: 10 cm), 1 stand, 2 magnetic wands, 1 ruler, 1 sorting tray, 1 manual

Children learn about magnetic forces and how they repel or attract and about 'floating' magnets. They design patterns with the iron filings and the wands.

Warning Notice: 1 (page 271)

**85141V90** Set

### Swimming compass

Gives children a first impression of the principles of magnetism and helps to determine the cardinal points. Incl. plastic bowl that can be filled with water.

Magnet size (w x h): 8 x 3 cm, diameter bowl: 13.5 cm

**760791V90**



### Magnetic Marbles

Set of 20 magnetic marbles in 10 colours  
Diameter: 1.5 cm

Warning Notice: 5 (page 271)

**87621V90**



### Magnet Wands

Set of 7 magnetic wands in 7 colours  
Engage students in hands-on magnetism activities.  
Great for physical science centers.

Height: 20 cm

**85589V90**



### Horseshoe Magnet

**85594V90** Small, 12 x 12 x 2 cm

**85593V90** Large, 20 x 20 x 2.5 cm



### Iron Powder

Iron powder in a sealed plastic case. See how iron powders react with magnets and show magnetic fields without the mess. Dimensions (H x W x D): 1 x 9.7 x 7 cm

Warning Notices: 1, 2 (page 271)

**754594V90**



### Set of Magnets

15 magnets in different shapes. Height horseshoe: 4.5 cm. To introduce the concept of polarity.

Warning Notice: 1 (page 271)

**85139V90** Set



### Floating Magnets

Children learn that magnets have 2 poles and how same poles repel and opposite poles attract each other.

**Content:**

base with magnet (height: 10 cm)

4 ring magnets in different colours (3.2 cm)

Warning Notice: 32 (page 271)

**85591V90**



STATION 1  
MAGNETS ATTRACT, MAGNETIC OR NOT, MAGNET SHAPES



STATION 2  
EXPERIMENTS WITH MAGNETIC FORCES OF VARYING STRENGTH



STATION 3  
MAGNETS ATTRACT OR REPEL EACH OTHER



STATION 4  
THROUGH WHICH MATERIALS MAGNETS ARE EFFECTIVE



STATION 5  
MAGNETIC FIELDS



STATION 6  
WE BUILD DIFFERENT COMPASSES



STATION 7  
WE BUILD ELECTROMAGNETS

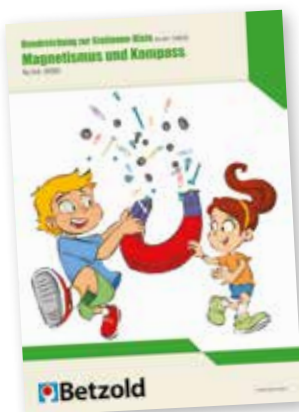

## DISCOVERY KIT MAGNETISM AND COMPASS

- > ACTIVE LEARNING
- > CAN BE USED WITHOUT MUCH PREPARATION
- > 7 FULLY DEVELOPED LEARNING STATIONS
- > 27 EXPERIMENTS



### Discovery Kit Magnetism and Compass

The station set allows you to perform effective lessons with different stations without great preparations. All stations and experiments are already prepared and explained in detail. All materials needed for the experiments (except batteries) are already included. The whole class can experiment and observe on 7 different stations.

27 cards with the following tasks: What is magnetic and what is not? What kind of magnets are there? How do they react to each other? How far do they reach? How does a magnet form? What does a magnet consist of? What are magnetic fields? How is a compass set up? How does it work? How do you build a string compass or a water compass and how do you build an electromagnet?

The observations can be written down on the working sheets (copy sheets). Detailed explanations, solutions and further information are included in the handout.

The electromagnet requires 2 batteries type AA Mignon and 1 flat battery 4.5 V (3R12), not included.

Warning Notices: 1, 2, 5, 32 (page 271)

**754632V90** German Version





### Tray for Experiments

Plastic tray, Dimensions (H x W x D): 1 x 33 x 24 cm  
Very useful to transport the results of the experiment  
**81892V90**



### Dropper Bottle

For a correct filling. Capacity: 50 ml.  
Made of polyethylene.  
**86029V90**



### Thermometer

-10 °C to +110 °C, 30 cm. Made of glass.  
In a sturdy plastic tube.  
Warning Notice: 41 (page 271)  
**85753V90**



### Sorting Trays

Set of 5 white trays  
Dimensions (H x W x D): 3 x 18 x 12 cm  
**70883V90** Set of 5



### Transparent Sorting Tray

Made of food-safe plastic, dishwasher safe  
Dimensions (H x W x D): 5 x 23 x 15 cm  
**850106V90** Set of 5

# GREAT LABORATORY EQUIPMENT



### 14 Test Tubes

In a rack  
**Content:** 14 test tubes in a rack, diameter: 2.4 cm, height: 10.5 cm.  
All test tubes are to be closed with a plastic cork.  
Warning Notice: 1 (page 271)  
**52102V90**

### Goggles

Clear flexible plastic goggles. Elastic strap on the back.  
Sized to fit a child's face.  
Warning Notices: 1, 8 (page 271)  
**86034V90**





### Mobile Laboratory for Students

The large material wagon contains everything you need to perform exciting experiments with your children. Up to 16 children explore in groups natural science phenomena.

**Flexible usability:** The practical material wagon can be moved easily to every place of action. The wheels can be dismantled.

**Practical ordering system:** The materials are sorted in 8 removable drawers.

#### Content for 16 children:

- 16 goggles
- 16 bug viewers
- 32 measuring cups
- 24 colour powders for colour experiments
- 32 test tubes
- 8 test tube racks
- 8 pipettes
- 24 powder bottles
- 8 measuring spoons
- 24 petri dishes with three partitions
- 8 thermometers
- 8 dropper bottles
- 8 spray bottles
- 24 boxes with lid
- 8 magnifiers with 7x magnification
- 1 roll container with 8 drawers

Dimensions of the cart (H x W x D): 86 x 30 x 38 cm

Warning Notices: 1, 2, 8, 41 (page 271)

**83979V90**

## MOBILE EXPERIMENT LAB WITH 249 PARTS

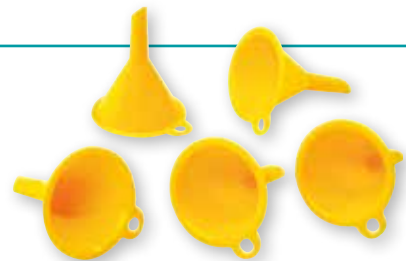

### Plastic Funnels

Perfect to fill test tubes and other small containers.  
Diameter: 4 cm

**52109V90** Set of 5



### Droppers

14.5 cm, 3 ml

**900609V90** Set of 6



### Wash Bottle

Plastic  
Flexible-walled bottle, with screw cap and bent tube  
Capacity: 500 ml

**86030V90**



### Petri Dishes

With three partitions and cover.  
Diameter: 9 cm, height: 1.5 cm

**52106V90** Set of 3



### Petri Dishes

Transparent plastics with cover for different kinds of experiments.

Diameter: 9 cm, height: 1.5 cm

**52105V90** Set of 3



**MAGNETIC**



### The Roadworthy Bicycle

This teaching aid demonstrates which vital parts are necessary to make a bicycle roadworthy: lights, a bell, and reflectors ... A large magnetic poster can be placed on the blackboard. Using the detailed magnetic bicycle parts students will be able to build a bike safe for traffic. The word cards in English and German can be used for bilingual teaching.

- > 1 bicycle poster / magnet (2 panel set), 66 x 48 cm
- > 8 bicycle parts / magnet, diameter: 13 cm
- > 8 word cards (double-sided, English/German)

**754488V90**



### Exploring Kit Gears

Discover the principles of gears transmitting motion. Learn to set up a configuration following the scheme on the instruction card and discover how a gear train is formed. A variety of experiments can be performed using different types and sizes of gears, observing differences in direction and in speed ...

#### Content:

4x base grids, 5x rods, 2x short frames, 2x rubber bands, 4x pulley blue (2x small, 2x large), 3x chain gear yellow (1x small, 2x large), 4x L gear yellow, 7x M gear blue, 7x S gear red, 28x S axle red, 5x M axle black, 1x unit chain (41 units), 1x peg/axle remover, 10x cam connector red, 10x work cards with the assignment on the front and the solution on the back

Warning Notice: 1 (page 271)

**88415V90**



### Wooden Construction Slats

Construct freely or try to build self-supporting buildings like Leonardo bridges or domes without glue or nails. Wooden Construction Slats, small

**Content:** 99 pcs, Dimensions (L x W x D): 18 x 2 x 0.3 cm, birch, construction manual included  
**760464V90**

### Wooden Construction Slats, large

**Content:** 45 pcs, Dimensions (L x W x D): 36 x 4 x 0.5 cm, birch, construction manual included  
**760465V90**





### Water Purification Kit

Learn two different techniques of water filtration with this water purification kit! Three experiments take kids through the steps of purifying water through filtration with gravel, sand, activated carbon and filter paper. One distillation experiment illustrates the concept of evaporation, the water cycle, and states of matter. This kit for making clean water contains gravel, sand, carbon, filter paper, and a multi-level filter device. You supply a few common household items like soil, cooking oil, clear plastic cups, tape, and coffee.

Note: Performing the experiments in this kit produces filtered and distilled water, but it is not safe for human consumption. Drinking water must also be disinfected. However, you can use your cleaned water for plants, if you wish.

#### Content:

1 evaporating dish, 1 evaporating dish cover, 2 cups with 2 holes, 2 cups with 4 holes, 1 cup holder, 1 non-perforated cup, 1 pack activated carbon, 1 pack gravel, 1 pack sand, 10 filter papers, instructions  
Warning Notices: 1, 2 (page 271)

84738V90



## WATER PURIFICATION KIT



### Experiment Box: Swimming and Sinking

Can a cork float? Which weight drops the fastest? The children can answer these questions independently by experimenting with this set. The set offers many opportunities to teach children about swimming and sinking objects and materials.

#### Content:

- › 5 polystyrene balls (Ø 30 mm)
- › 5 polystyrene balls (Ø 60 mm)
- › 5 corks
- › 5 foam cubes
- › 5 wooden cubes
- › metal weight set  
(2x 1 g, 2x 2 g, 2x 5 g, 2x 10 g, 2x 20 g, 1x 50 g)
- › 2x clay (red, 65 g)
- › 5 measuring cups  
(50 ml, 100 ml, 250 ml, 500 ml, 1000 ml)
- › storage box

Warning Notices: 1, 2, 5 (page 271)

59322V90



Minimum order: € 400,-

# MUSIC



## Rhythm Set in Bag with 19 Instruments and 4 Beaters

Very stable bag with different compartments to store the instruments. Can be hung opened.

In the 6 compartments you find all kind of instruments with all kind of sounds. Ideal for music activities.

**Content:** 2 tambourines (diameter: 20 cm and 15 cm), 5 triangles (10–20 cm), 2 wooden maracas, 1 giant guiro with scraper, 2 tone blocks, 1 wood block, 2 colourful castanets, 1 handled castanet, 1 wooden tone block, 1 pair of claves, 1 metal shaker. Dimensions of the closed bag (H x W x D): 10 x 39 x 42 cm

**8319V90**

As long as available



## Extended Rhythm Set in Bag with 26 Instruments and 4 Beaters

Next to the instruments from the left side there are following instruments:

3 handbells with 10 jingles, 1 jingle stick, 1 maracas stick, 2 pair wooden claves

**8320V90** Set

As long as available



## Box with 26 Shakers

4 large wooden maracas  
6 egg shakers  
4 mini maracas, plastic  
2 wooden mini maracas  
2 calabash shakers  
2 skin maracas  
6 fruit shakers

Warning Notice: 43 (page 271)

**84214V90**



## Class Kit Rhythm Instruments

Instruments made of wood, metal or plastic for every child.

**Content:**

1 tulip block red, 1 tambourine (diameter: 20 cm)  
1 handbells (diameter: 20 cm), 4 egg shakers  
4 pair claves, 1 tone woodblock  
1 wooden guiro, 1 four tone woodblock  
1 pair mini-maracas, 2 jingle bells  
2 handled bells, 1 wooden handled castanet  
4 castanets  
1 headless wooden tambourine  
1 headless plastic tambourine, 2 pairs of finger cymbals  
1 triangle (15 cm), 1 triangle (10 cm)

All 30 instruments: in storage box (20 x 48 x 38 cm)  
Warning Notice: 43 (page 271)

**81950V90**



# THE NEW RHYTHM BAGS ARE AVAILABLE!

## Rhythm Bag

Very stable rhythm bag with adjustable shoulder strap and 2 plastic wall hanger. Inside are 6 pockets and 1 loop for sticks. 4 of the pockets have pocket flaps.

### Content of both:

- 1x guiro with scraper
- 2x castanets
- 1x handled castanet
- 4x egg shaker
- 1x tone block
- 1x wooden tone block
- 1 pair of finger cymbals
- 2x wood blocks
- 3x triangles
- 1 pair of claves
- 1x tambourine
- 1x big handbell with 12 jingles

### Additional content of bag with 26 instruments:

- 3x small handbells with 10 jingles
- 1x jingle stick
- 1x maracas stick
- 2 pairs of wooden claves

Dimension of closed bag: 42 x 39 x 10 cm

Material: 100% polyester

All Warning Notice: 43 (page 271)

**758325V90** Rhythm bag with 19 instruments

**758326V90** Rhythm bag with 26 instruments

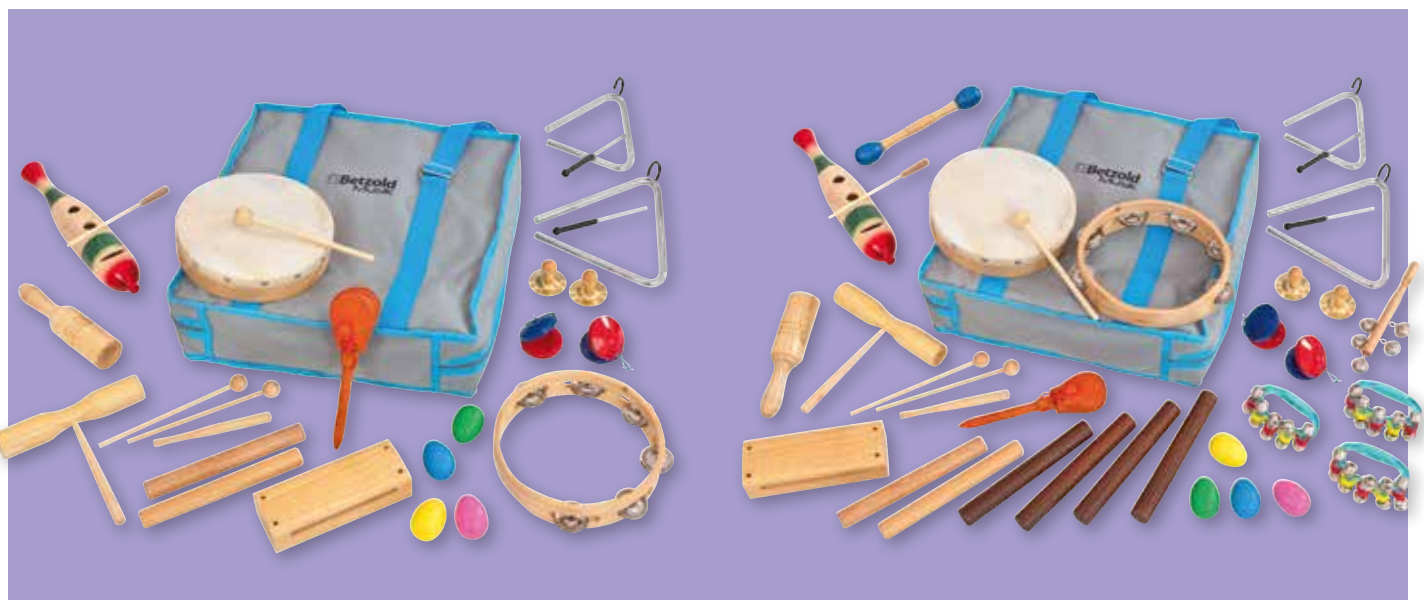



**Big Two Tone Block**

Quality hardwood block with a handle. Loud and resonant. Dimensions: Width: 20 cm, diameter: 4.5 cm  
**5207V90** With mallet



**Two Tone Block**

Produces two different tones. Dimensions: Width: 19 cm, diameter: 3 cm  
**5276V90** With mallet



**Wooden Tone Block**

Dimensions: Width: 18 cm, diameter: 4.5 cm  
**5206V90** With mallet



**Wooden Guiro with Beater**

Dimensions: length: 20 cm, diameter: 3.5 cm  
**5208V90** With mallet



**Two Tone Guiro**

Dimensions: length: 25 cm, diameter: 4 cm  
**5209V90** With mallet



**Tone Wood Block**

Can be played while holding in the hand or put on a stand. Slotted one side, sharp sound, natural wood. Supplied with a mallet.  
 Dimensions (H x W x D): 3 x 18 x 7 cm  
**4149V90**

KEEP THEM  
 MOVING!



**Mini Cabasa**

For small hands. Ideal for special effects. Dimensions: diameter: 6 cm  
**4972V90**



**Afuche Cabasa**

Rest the flat of your hand on the beads and move the beads around the cylinder rhythmically using long and short strokes. Easy to play. Dimensions: diameter: 10.5 cm  
**4971V90**



**Fish Guiro**

Fish-shape, length: 31.5 cm. Easy to handle.  
**4088V90** With scraper

**Large Mexican Guiro**

Fish-like shape, with scraper, length: 40 cm  
**4380V90** With scraper



**Tulip Block**

Red block with a handle. Produces a loud clear tone. Length: 25 cm  
**4844V90** With beater



**Fruit-Shaker-Set & Corn-Guiro**

Orange, banana, lemon, kiwi fruit, mango or corn. A set of shakers, each with its very own sound. And the best of all: Additionally the corn can be used as a guiro.  
**84029V90** Set of 6 instruments





### Mini Maracas (wood)

Made from quality wood. Length: 12 cm  
**9960V90**



### Mini Maracas (plastic)

Made of durable plastic  
Length: 12 cm  
**9961V90**



### Wooden Maracas

Colourful with carved and painted design  
Small – ideal for children's hands.  
Oval, length: 15 cm  
**8862V90** Pair



### Wooden Maracas

Oval, length: 25 cm  
**5028V90** Pair



### Egg Shaker Maracas

Egg shakers with handles. Supplied in packs of 2 – in different colours. Two different sounds.  
Length: 12 cm  
**5396V90** Pair



### Egg Shakers

Mini-maracas in the form and the size of an egg with a subtle difference in sound between each colour. The pitch level declines from yellow to pink, green and blue.  
Set includes 4 eggs (yellow, pink, green, blue);  
Length: 5 cm  
Warning Notice: 43 (page 271)  
**4955V90** Set of 4



### Big Egg Shakers

Sound is warmer and deeper than the sound of the smaller chicken shakes. Made from quality wood, very nice finish. Dimensions: 8 cm  
**8852V90** Pair



### Claves – Laurel

Length: 20 cm  
**9796V90** Pair



### Beech Wood Claves

Producing a big sound.  
Dimensions: length: 21 cm, diameter: 2.4 cm  
**5266V90** Pair

# GET THE RHYTHM!

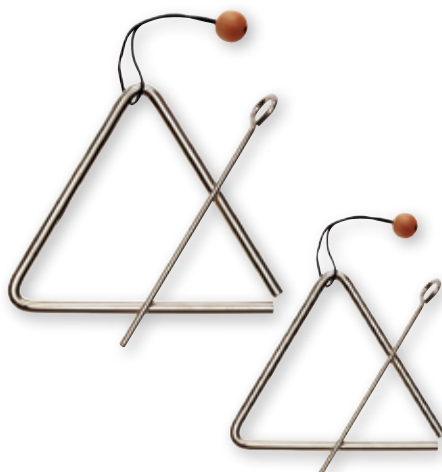

### Triangles

With mallets and holders. Diameter: 8 mm

- 5320V90** 10 cm
- 5321V90** 15 cm
- 5322V90** 20 cm
- 5323V90** 25 cm

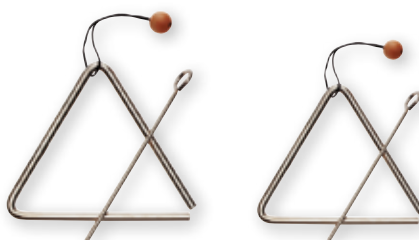



### Hand Held Jingles

With 10 bells  
 Very nice design – grip is made of sturdy plastic.  
 The jingles are sure to be a big hit with children.  
 Clear sound.

Size: 10 cm  
**8310V90**



### Wrist Jingles

On a sturdy strap, 22 cm long, Velcro® fastening.  
**4408V90** 4 bells

The same as 4408V90 but with 5 bells. 22 cm long  
**8858V90** 5 bells

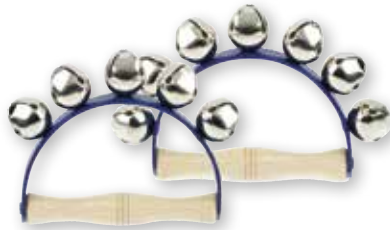

### Hand Held Jingles

Bells on a plastic band. Screwed onto a wooden handle.  
 Impressive sound.  
 Size: 15 cm

**8872V90** 5 bells  
**8871V90** 7 bells



### Body Jingles

With 10 large bells  
 Attached with Velcro®. Deeper sound.  
 Length: 83 cm

**8857V90**



### Castanets

Diameter: 5.5 cm  
**4155V90** Pair



### Finger Cymbals

With elastic straps. Pair – brass – diameter: 6.4 cm  
**4897V90**



### Brass Cymbals on Wooden Handles

Set of two small brass finger cymbals with wooden handles. Classroom music standard, easy to play. They add a fun sound element to the classroom ensemble.  
 Pair, diameter: 5.4 cm

**84144V90**



### Stick Castanet

Quality wood, length: 21 cm  
**4157V90**



### Cymbals

These brass cymbals have good tonal quality. Give a bright clear sound. With leather straps. Pair

**5327V90** Diameter: 15 cm  
**5329V90** Diameter: 20 cm  
**5331V90** Diameter: 25 cm

### Set of 3 Hand Drums

For Latin American and other Rhythms

Tunable heads (the same way as Bongos). Can be played with the hand or with a mallet. Can also be put on the floor or on the table while playing.

Sizes: 20 cm, 25 cm and 30 cm, 1 stable bag, 3 mallets

**4670V90**



### Stick Jingle

25 bells on a stick. Reminds you of the sleigh bells.

Dimensions (W x H): 30 x 6 cm

**5804V90**



### Wooden Jingle Stick

With 6 pairs of tambourine jingles.

Length: 30 cm

**5799V90**



### Headless Tambourines

**5260V90** Diameter: 20 cm, 6 pairs of jingles

**5261V90** Diameter: 25 cm, 8 pairs of jingles

### Slit Drum

This 4 tone slit drum has a beautiful tone.

Comes with a felt beater.

Dimensions (H x W x D): 11 x 32 x 12 cm

**89230V90**



### Hand Drums

With nylon skin. Can be played with the hand or a mallet.

**84197V90** Diameter: 20 cm, with mallet

**84198V90** Diameter: 25 cm, with mallet

**84200V90** Diameter: 35 cm, with mallet





**BEST  
SELLER**



**Tambourines**

Tunable, with tension rods.

**4143V90** Diameter: 20 cm + mallet

**4144V90** Diameter: 26 cm + mallet

**4145V90** Diameter: 28 cm + mallet

# TAMBOURINES

**Hand Drums**

Tunable

Plastic heads. Tunable with tension rods.

Plastic heads have a constant tuning. No need to retune them because of a change in temperature or humidity.

**8904V90** Diameter: 20 cm + mallet

**8903V90** Diameter: 25 cm + mallet

**8902V90** Diameter: 30 cm + mallet



**Tambourines**

Without tension rods, not tunable.

**4180V90** Diameter: 20 cm + mallet

**4181V90** Diameter: 25 cm + mallet



**Small Conga with Removable Strap**

High sound. Height: 28 cm, diameter: 20 cm. Made of wood. Natural skin. Tunable with 4 tension rods.

**8446V90**



**Maple Bongos**

1 pair of tunable bongo drums with diameter: 19 x 16 cm heads.

**4956V90**





### Kazoos

Easy to play as a special effect instrument for your school lessons. Reading notes is not necessarily required. By speaking or humming the membrane inside the Kazoo is set into vibrations, and out comes the typical buzz sound. Effectiv way for children to overcome their inhibitions of singing in front of others

- > jar with 40 Kazoos, assorted colours
- > instruments are washable
- > length: 12 cm

**754575V90**



### Ocean Drum

Recreate the sound of the crashing waves of the sea. This two-headed drum has a clear head on one side and a head printed with a sea design on the other. It has steel beads inside and a robust fabric on the bottom. Create wonderful sound effects simply by shaking or tilting the drum. Diameter: 35 cm

**84401V90**



### Percussion Chimes

Solid percussion chimes of polished aluminum and free floating in a wooden base create an outstanding pure and bright tone. The rods are ideally tuned to one another. Well-suited for special effects or as a signal during playtime and independent work.

**Trio percussion rods, c<sup>1</sup>, e<sup>1</sup>, g<sup>1</sup> chord** (wooden base 20 cm), wooden striking mallet included

**89216V90**



### C-Recorder

Made of high quality plastic. Easy to clean.

**5134V90**



### Lotus Flute, wood

Different sounds are produced by shifting back and forth a bar inside the tube, thus shortening or lengthening the column of air. Length: 18 cm

**89283V90**



### Rainmaker

**4272V90** Diameter: 4–6 cm, 50 cm

**4273V90** Diameter: 6–8 cm, 50 cm

**4274V90** Diameter: 6–8 cm, 100 cm



### Rainmaker

Plastic rainmaker, with colourful plastic beads to create the sound of a downpour. The combination of sound and colour makes this product a delight for children.

Length: 30 cm

Warning Notice: 1 (page 271)

**9984V90**

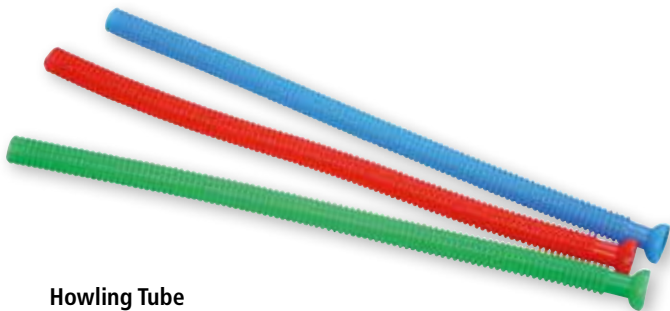

### Howling Tube

Hardly any other toy turns bodily movement more directly into sound than the colourful howling tubes. These plastic tubes are very easy to play: Hold one end of the tube tightly with one hand and start spinning it around. By changing the speed of spinning you can create lower and higher notes.

Length: 74 cm

**42129V90**



**BEST  
SELLER**



# BOOMWHACKERS

Perfectly tuned percussion tubes

Made of high quality plastic. The tubes are perfectly tuned to different musical notes which are clearly marked on their labels.

Hundreds of songs can be played on the various sets listed below. Whack almost anything to produce sounds – table, chair, floor, hand ...

Different surfaces produce different sounds, but always the same musical pitch. You can also play chords by combining the tones.



Increase the tonal range by also ordering the octavator caps. Fit a cap to the end of the tubes and the tone is dropped by one octave – making a full 2 octave range of tubes available.

Easy to play and to learn about rhythm, melody and harmony in a fun way.



## Storage Box for Boomwhackers

Holds ca. 40 Boomwhackers, cardboard  
Dimensions (H x W x D): 21 x 46 x 30 cm

**86935V89**

As long as available



## Octavator Tube Caps

Set of 8 Tube Caps  
Lower the pitch by one octave.

**6890V90**



### Boomwhackers, diatonic

Diatonic Set with 8 tubes  
 $c^1 - c^2$  range (upper octave)

**6936V90**



### Boomwhackers, chromatic

5 Note Chromatic Set with 5 tubes (upper octave)  
 $c\sharp^1, d\sharp^1, f\sharp^1, g\sharp^1, b\flat^1$

**6937V90**



### Boomwhackers, pentatonic

6 Note Pentatonic Set  
With 6 tubes:  $c^1, d^1, e^1, g^1, a^1, c^1$

**6935V90**



### Boomwhackers Soprano Set

Treble Extension Set  
With high  $c\sharp^2, d^2, d\sharp^2, e^2, f^2, f\sharp^2$ , and  $g^2$

**6893V90**

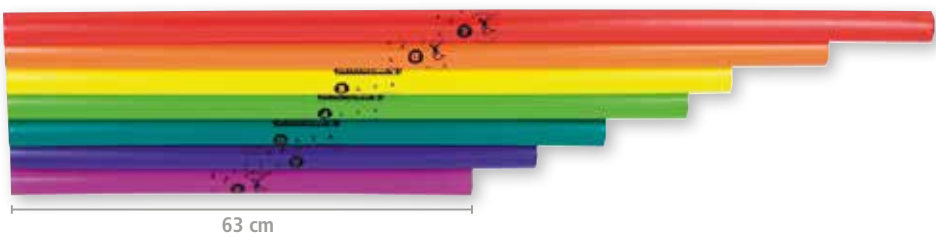

### Boomwhackers Bass Set

7 Notes  
Diatonic set (lower octave)  $c, d, e, f, g, a, b$

**6965V90** Set of 7 tubes

### Boomwhackers Bass Set

5 Notes  
Chromatic set (lower octave)  $c\sharp, d\sharp, f\sharp, g\sharp, b\sharp$

**6966V90** Set of 5 tubes



### Boomwhackers Dice

Dimensions: 10 x 10 x 10 cm  
Features the same colours as the pentatonic boomwhackers set (6935V90)

Warning Notice: 1 (page 271)

**88812V90**



### Chroma-Notes™ Stick-Ons

Chroma-Notes™ Stick-Ons are removable stickers coloured according to the boomwhackers colour scheme for colour-coding other instruments such as glockenspiel, sound tubes ... to make it easier for children to learn and to play notes. The stickers are removable and reusable. Some writeable blank stickers are included as well.

The set contains 500 stickers, consisting of:  
300 pcs. diatonic with letters,  
100 pcs. diatonic without letters,  
75 pcs. chromatic with sharp/flat spelling,  
25 pcs. chromatic without sharp/flat spelling

**84475V90**

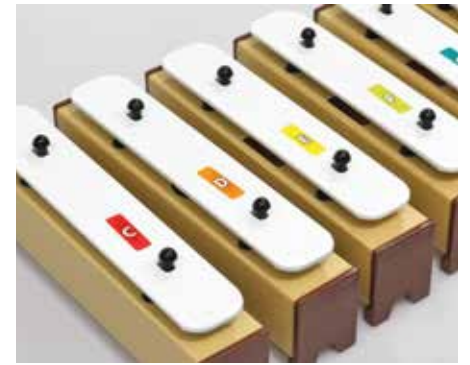

### Boomwhackers Glockenspiel

The colours and the tones of the notebars match those of a diatonic set boomwhackers (6936V90). This makes it easier for the children to start playing on glockenspiel.  $c^2-c^3$ , Length: 24 cm

**88810V90**

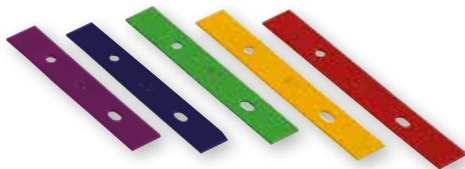

### Chromatic Set

Set of 5 notebars (colours matching 6937V90)

**88811V90**

### Wooden Stand

Dimensions: 45.5 x 13.5 x 4.5 cm  
Ideal way to store the boomwhackers.

**8935V90**



### Boomwhackers Xylo Tote Tube Holder

A whole new way to play your boomwhackers like a xylophone! Used as a carrier, it accommodates 8 Boomwhackers and a pair of mallets. Two or more can be combined end-to-end for a wider range of play. Made of cotton, elastic and hook-and-loop fasteners.

**900573V90**





## MAGNETIC



### Rhythm & Beat Cards a Whole-Class Experience, 86 Pieces

Introduce Boomwhackers to your class with colourful magnetic board materials. Students will play the Boomwhackers without any knowledge about music notation. Endless preparations and uncountable copies belong to the past: Place the cards on the board and count the beat aloud in front of the class. Children will know their cue by looking at the board.

Age: 5+

#### Content:

- › 64 dry-erase magnets (16 red & orange, yellow, pink, purple, light green, dark green – 8 each), 8 x 8 cm
- › 10 beat card magnets with numbers (2 of each: 1, 2, 3 and 4; 1x 5, 1x 6)
- › 12 blank card magnets
- › 1 folder with master copies & instructions

84662V90



### Boomwhackers Rhythm and Tact Cards, Chromatic Addition

Set with rhythm and tactcards in the colours of the chromatic addition of the Boomwhackers tubes. Magnetic board material.

**Content:** 40 cards (each 8x in the colours light red, light orange, dark green, blue, violet).

Card dimensions (W x H): 8 x 8 cm

760281V90

### Rainbow Sound Tubes

The chimes of these instruments are mounted on round plastic tubes (in the boomwhackers colours) for a better resonance and an excellent sound. Delivered in a sturdy carrying bag.

**88960V90** Set of 8 chime bars  $c^1$ – $c^2$  and 8 mallets



### Rainbow Sound Tubes, Chromatic Addition

Expand the application spectrum of the rainbow sound tubes (88960V90) by adding  $c^\sharp$ ,  $d^\sharp$ ,  $f^\sharp$ ,  $g^\sharp$  and  $b^b$ . Delivered in a carrying bag, 5 mallets included.

**84015V90** Set of 5



### 10 Note Handbell Set

Top quality construction and accurate intonation. Each metal bell is colour coded with the proper note to help children learn the musical scale.  $f^\sharp$  and  $b^b$  have black handles.

Every child gets his own bell to play in the hand or on the table. The colours correspond to the colours of the boomwhackers. Height: 13.5 cm

### Set of 10 Bells

with a handle (diatonic set with  $f^\sharp$  and  $b^b$ )

**8535V90**



### Set of 10 Bells

with handle (diatonic set with  $f^\sharp$  and  $b^b$ )

Height: 13.5 cm

In a sturdy carrying bag

**88905V90**

### Chromatic Additional Notes

Set of 3 hand bells,  $c^\sharp$   $d^\sharp$ ,  $g^\sharp$

Height: 14 cm, diameter: 7.5 cm

**84566V90**



### Set of 10 Desk Bells with Push-Knobs

Top quality construction and accurate intonation. Colour coded with the proper note to help children to learn the musical scale.  $f^\sharp$  and  $b^b$  have black knobs.

Diatonic set with  $f^\sharp$  and  $b^b$ , diameter: 7 cm

**8528V90**

**88912V90** In a sturdy carrying bag

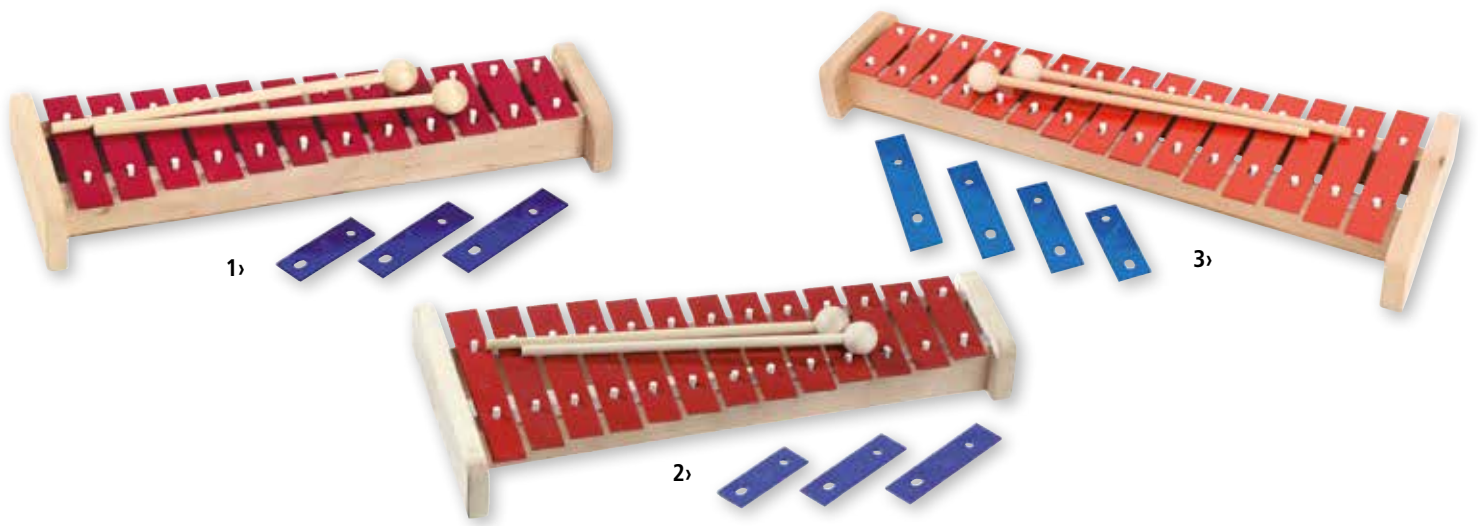

#### 1) Soprano Glockenspiel Diatonic

32 cm long, diatonic  $c^3-g^4$  (with  $f\#^3$ ,  $b^b3$ ,  $f\#^4$ ) 15 notebars, 20 x 2 mm, 1 pair of mallets. Notebars are red.  $f\#^3$ ,  $b^b3$ ,  $f\#^4$  are blue.

88600V90

#### 2) Alto Glockenspiel Diatonic

34 cm long, diatonic  $c^2-a^3$  (with  $f\#^2$ ,  $b^b2$ ,  $f\#^3$ ) 16 notebars, 20 x 2 mm, 1 pair of mallets. Notebars are red.  $f\#^2$ ,  $b^b2$ ,  $f\#^3$  are blue.

88638V90

#### 3) Soprano Glockenspiel

37 cm long, diatonic  $g^2-g^4$  (with  $b^b2$ ,  $f\#^3$ ,  $b^b3$ ,  $f\#^4$ ) 19 notebars, 20 x 2 mm, 1 pair of mallets. Notebars are red.  $b^b2$ ,  $f\#^3$ ,  $b^b3$ ,  $f\#^4$  are blue.

88601V90

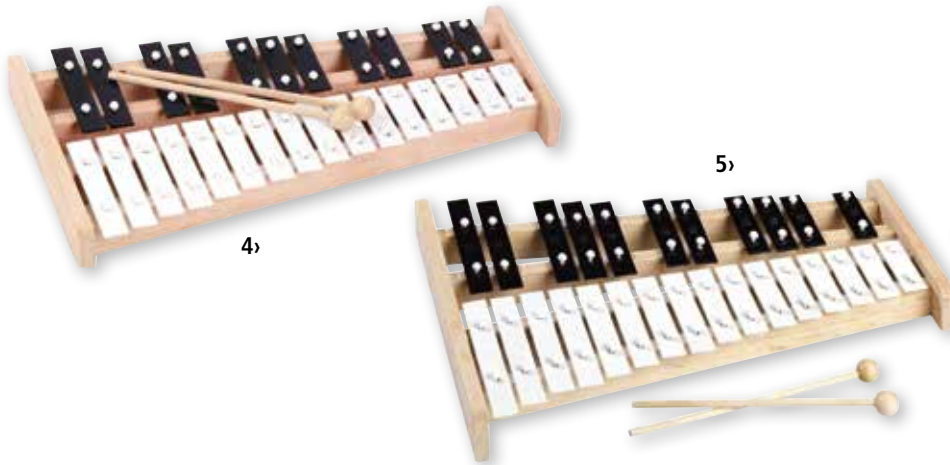

#### 4) Soprano Glockenspiel Chromatic

41 cm long, 24 cm wide 27 notebars (chromatic scale from  $g^2-a^4$ ). All tonalities can be played without changing the notebars. It looks like the keyboard of a piano

88602V90

#### 5) Alto Glockenspiel Chromatic

41 cm long, 30 cm wide 27 notebars (chromatic scale from  $c^2-d^4$ ). All tonalities can be played without changing the notebars. It looks like the keyboard of a piano.

88639V90



#### 6) Carrying Bag

For Soprano Glockenspiel Chromatic  
Dimensions (H x W x D): 6 x 46 x 28.5 cm  
Material: 100% nylon

84665V90

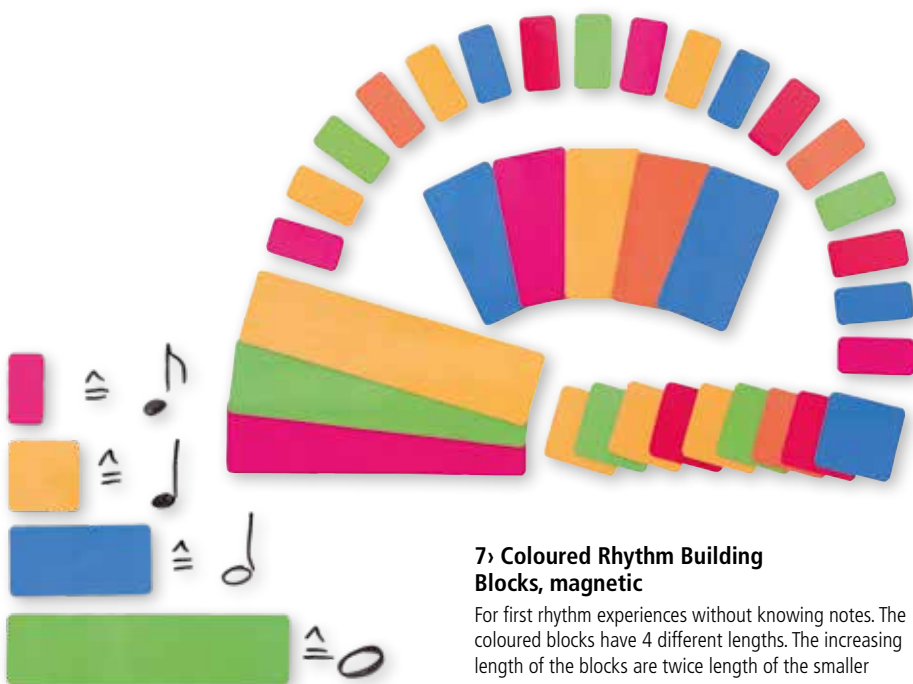

#### 7) Coloured Rhythm Building Blocks, magnetic

For first rhythm experiences without knowing notes. The coloured blocks have 4 different lengths. The increasing length of the blocks are twice length of the smaller



block. Children clap their hands intuitively faster the shorter the rhythm block length is.

758497V90 54 parts



**NEW**



### Music Rainbow Glockenspiel

**Content:** 8 metal bars on felt mats, wooden frame, 2 wooden sticks

Frame size (H x W x D): 5 x 24.5 x 16.5

**759634V90**

### Chromatic Addition to Music Rainbow Glockenspiel

**Content:** 5 metal bars, tones: cis<sup>2</sup>, dis<sup>2</sup>, f#<sup>2</sup>, gis<sup>2</sup>, b<sup>b2</sup>

**759636V90**



### Classical Guitar Concert Guitar 39" Valenzia AL 2339

Fir wood top, wooden body and neck, hardwood fingerboard, high gloss finish, bone nut 50 mm, diapason 65 cm

**88685V90**

**89512V90** Set of 6 Replacement Strings 39"

### Acoustic Guitar 1/4 (Size 30")

Body material: Basswood, glossy finish, bone nut 48 cm

**84670V90**





**Desktop Metal Music Stand**

Folds compactly, carrying bag included  
 Dimensions (W x H): 46 x 23 cm  
**84181V90**



**Rhythm Dice, 3 cm**

Wooden dice with quarter and eight notes and quarter rests.  
 Warning Notice: 1 (page 271)  
**5007V90** Set with 4 dice



**Penta Dice, 3 cm**

Wooden dice with notes (c, d, f, g, a, c') in a pentatonic scale. It doesn't matter in which sequence the notes are thrown, played or written, the result is always a very nice melody.  
 Warning Notice: 1 (page 271)  
**5178V90** Set of 5 dice



**Note Values Game**

Good visual aid for explaining/comparing note values. Completes the Magnetic Music Whiteboard. Consists of 34 magnetic note cards. Without Music Whiteboard  
**84681V90**

**Magnetic Music Whiteboard**

Great for improving music reading skills. Children instantly recognise musical notes, rests, accidentals and time signature. The magnetic notes make it very easy to compose scales, intervals, rhythm, triads and own music. The surface is a dry erase board and can also be written

on with whiteboard markers for free composing. 1x whiteboard with 2 music staves (treble and bass clef), 23 x 31 cm, 33 colourful magnetic elements (music notes, sharps ...)  
**84145V90**

FOR LITTLE MUSICIANS



**Folding Music Stands**

Folds compactly for easy transport. Maximum height: 145 cm. Desk: 43 x 23 cm. Folds down to 37 cm. Weight: 1.1 kg  
**4819V90** Black  
**4855V90** Silver



**Guitar Stand**

Ideal for school band concerts. The guitar is securely placed during breaks or when switching instruments. Folds flat for easy storage and travel.  
**84159V90**





### Magnetic Grading System

No music room available and you have no music board? No problem! With this mobile magnetic grading system you can teach music theory on any black board. Just attach the stripe on the inner side of the black board (can be cut to size if needed) and lessons can start right away. The grading system is magnetic as well as magnet adhering, meaning you can also work with magnetic music notation sets. Can also be written on with white-board markers.

Dimensions (W x H): 195 x 27 cm

Line distance: 2.5 cm

Scope of delivery does not include notes.

84631V90



MAGNETIC



MAGNETIC

### Magnetic Notation Set, black/red

Notation Set containing 240 pieces for flipcharts and white music boards. All notes and signs are made of sturdy plastic. The backside is magnetic and can be used for steel boards.

Size for standard staves with a line distance of 2.5 cm.

Colour: black/red

84632V90

### Magnetic Notation Set, black/red

in sturdy box with sorting tray and lid

84513V90

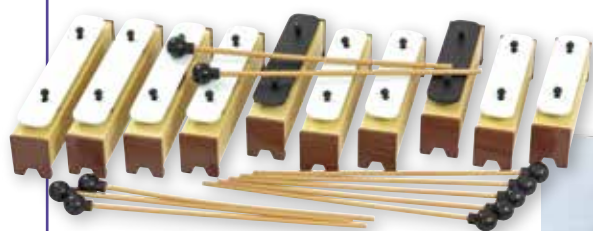

### Set with 10 Note Alto Chime Bars

Tonal range – from  $c^2$  to  $c^3$  with  $\sharp f^2$  and  $b^2$ .  
10 mallets included.

88814V90



# ARTS & CRAFTS



## Outdoor Easels made out of WPC

Two to three children can be creative at once. Adjustable high for the individual. The plastic trays are removable and dishwasher safe so are the paint pots. The panels are writable with whiteboard markers. Paper clips are included. WPC is wood-plastic composite and meanwhile often used for outdoors especially terrace floors.

### Double-sided WPC Easel

Dimensions (H x W x D): 120 x 59 x 50 cm

**756500V90**

### Three-sided Easel

Dimensions (H x W x D): 120 x 59 x 55 cm

**756501V90**



**BEST  
SELLER**



### Three-sided Easel

Dimensions (H x W x D): 129 x 67 x 58 cm

**11609V90**



### Four-sided Easel

Dimensions (H x W x D): 129 x 67 x 67 cm

**11612V90**

## Kindergarten Easel

Let a group of children paint at once with this durable easel. Just attach paper with the easel clips included or let children paint directly on the surfaces, and then wipe them clean.

The easel has no-slip leg tips and plastic trays to keep materials in reach. The frames are made of aluminium; the panels are writable with whiteboard markers and magnetic.



1



2



### 1> Triple Easel

- > made from sturdy beech wood
- > simple tray-mount mechanism
- > quick foldaway stow and erect
- > compartmentalised stationery tray
- > stationery bag and paint pots included
- > modern soft look with rounded corners
- > magnetic plus chalk board functions
- > white board plus clip board functions

Dimensions (H x W x D): 115 x 60 x 48 cm  
Material: beech wood, MDF

**756502V90**

### 2> Easel for Wall Mounting

- > made from sturdy beech wood
- > simple tray-mount mechanism
- > easy wall mounting
- > compartmentalised stationery tray
- > stationery bag and paint pots included
- > modern soft look with rounded corners
- > white board plus clip board functions

Dimensions (H x W x D): 115 x 58 x 0.5 cm  
Material: beech wood, MDF

**756504V90**

### Large Mobile Drying Racks

These large drying racks are perfect for classroom use. They are mounted on castors for easy transport. The racks are supplied in two sizes.

Material: galvanised steel tube/grid, shelf made from wood decor

4 castors – 2 lockable

For easy self-assembling (instructions enclosed)

#### Large Drying Rack with 10 Shelves

Dimensions (H x W x D): 88 x 94 x 60 cm

**756508V90**

#### Large Drying Rack with 15 Shelves

Dimensions (H x W x D): 114 x 94 x 60 cm

**756507V90**

#### Large Drying Rack with 25 Shelves

Dimensions (H x W x D): 153 x 94 x 60 cm

**57222V90**





**Itten's Colour Wheel**

This colour wheel according to Itten consists of 18 magnetic pieces. These can be fixed on the black- or whiteboard. It is also possible for them to be labeled with the enclosed blank-strips. The magnetic pieces adhere on top of each other, so that a clear classification to the colours is possible. Diameter: 60 cm

**Content:**

- > magnetic chromatic circle consisting of 18 pieces
- > 16 blank-strips for self-labeling
- > master copies

**757514V90**



**Paint Dryer**

14 drawings can be put in this cardboard frame. The shelves are made of water-proof cardboard. Supplied flat packed in its own packaging with easy assembly instructions.

Dimensions (H x W x D): 110 x 46 x 33 cm

**50394V90**

EVERY CHILD IS AN ARTIST



**Flip Over Drying Rack**

This drying system contains 2 separate racks. Arrange them side by side or on top of each other and store 16 pictures for drying at the same time. For paper sizes up to approximately 45 cm. When not in use, shut it easily to save space.

If you arrange the parts on top of each other, the height

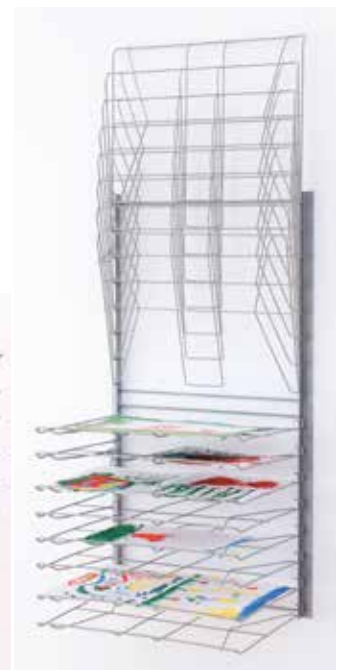

will add up to 120 cm and the width to 63 cm. If you hang them side by side, the height will be 60 cm and the width about 126 cm. For mounting directly to the wall.

**12473V90** Set of 2 racks, silver



**Canvas Panels, Set of 10  
Made of Recyclable Cardboard**

- 53903V90 15 x 20 cm
- 53904V90 25 x 30 cm
- 53905V90 40 x 30 cm
- 53906V90 20 x 20 cm
- 53907V90 30 x 30 cm



**Blank Painting Canvas**

Artist quality cotton canvas, 380 g/m<sup>2</sup>, triple coated with acrylic primer. Back stapled so that you can paint the sides and show your painting unframed. With wedges for easy tensioning. Available in three sizes:

- 81680V90 20 x 20 cm
- 81681V90 30 x 30 cm
- 81683V90 60 x 60 cm

Minimum order: € 400,-



### Kaleidoscope

Set of 10  
Change vision into fascination and assemble your own kaleidoscope.

**Content:** 10 tubes, 10 eye-pieces (punched), 10 discs, 10 bags with beads, mirrors, 10 caps  
Warning Notice: 1 (page 271)

**52120V90** Set of 10



### Make Your Own Periscope

Each periscope contains:  
2 mirrors, 2 pre-cut boards with folds for bending  
Includes 10 periscopes for assembling and decorating.  
The length of the periscope can be adjusted.  
Instructions included.

Warning Notice: 1 (page 271)

**52121V90** Set of 10



### Set of 12 Picture Frames

Design the frames and make personal and individual presents. Whether picture, poem or gift certificate, the frames give a personal touch. Dimensions: 8 x 8 cm

**52348V90** Set of 12

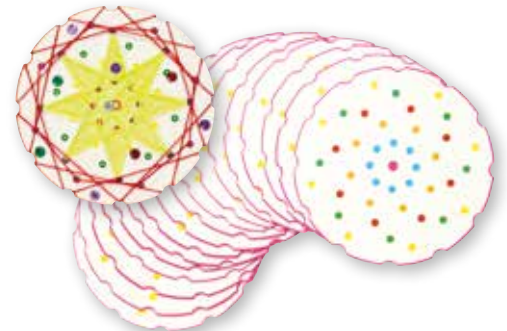

### Running-in-Circles

Thread in the coloured yarn and create beautiful patterns. Stitch for stitch children exercise patience and concentration.

Set with 24 circles, diameter: 15 cm

**50552V90**



### Gemstones, set of 12

Size per stone: approx. 2 cm. Please note: shapes, colours and size may vary.

#### Content:

1x red agate, 1x yellow agate, 1x blue agate, 1x grey agate, 1x green agate, 1x cairngorm, 1x rose quartz, 1x lapis lazuli, 1x achat pebble, 1x rock crystal, 1x white jade, 1x amethyst

**761557V90**



### Finger Puppets, 6 pcs.

For colouring in and role playing games.  
Fingers can be placed through the holes of every animal to enact as legs. The elephant gets a trunk.  
Material: 300 g/m<sup>2</sup> carton

### Finger Puppets Farm Animals

**Content:** chicken, cat, pig, sheep, cow and horse  
Dimensions: horse: 12 x 16 cm; measurements pig: 7.7 x 10 cm

**756882V90**

### Finger Puppets Safari Animals

**Content:** lion, monkey, zebra, giraffe  
Dimensions: giraffe: 7.5 x 17 cm; measurements monkey: 6.3 x 11 cm

**756884V90**



### A Building for Pictures

To be a part of this house enforces the group's togetherness.

Made of MDF (55 x 36.5 cm)  
For 28 photos (2.9 x 4.4 cm)

**53202V90**



### Wooden Lantern

Craft kit for one wooden lantern with easy plug-in system. Tailorable with all kinds of arts and crafts material.

Contains 4 side panels, 1 bottom panel and a wire for holding the lantern

Dimensions (H x W x D): 17 x 12 x 12 cm

Material: Plywood

Warning Notices: 2, 18 (page 271)

**759311V90**



### Blank Playing Cards (pack of 55)

Dimensions (W x H): 6.5 x 9.8 cm, in plastic box

**87975V90**



### Colour Mixing Set

Children can get to know basic understanding of colour theory in a playful way by mixing and creating new colours. The expression of colours and their moods affects our feelings. It's very fascinating for children to immerse themselves in the world of colour noise, diversity and experimentation.

Warning Notice: 1 (page 271)

**51412V90**



Minimum order: € 400,-

**NEW**

**Paper Crowns, 24 pieces**

Firm, white paper, paintable with wax crayons, coloured pencils or liquid colours. Head circumference can be adapted individually.

Height: approx. 13 cm, perimeter up to approx. 60 cm

Material: White craft paper

761644V90



**Garland Christmas**

These great garlands can be made with a little help by children age 3 and up all by themselves.

On the window, on the wall or hanging freely (we recommend to make one double-sided garland out of 2 garlands) the garlands look very pretty in the designs angel, star, tree, reindeer head, Santa hat or candle. They are perfect for the Christmas season.

Warning Notice: 43 (page 271)

12526V90



**Window Picture City**

Beautify the windows of your class room or group room with these city silhouettes (two different kinds in one set).

Equipped with glue sticks and scissors you can create a great window picture real easy. Just glue transparent paper to the windows and doors of the punched out window picture and your "city of light" picture is finished.

12524V90



**Garland Forest**

These great garlands can be made with a little help by children age 3 and up all by themselves.

On the window, on the wall or hanging freely (we recommend to make one double-sided garland out of 2 garlands) the garlands look very pretty in the designs fox, hedgehog, deer, squirrel, maple leaf or mushroom. They are perfect for the autumn season and for various educational topics as well.

Warning Notice: 43 (page 271)

12525V90





### Christmas Die Cut

Punched-out motifs made of white cardboard. Assortment of various sizes.

**Content:**

100 stars, 100 hearts and 100 Christmas trees.  
Dimensions: 6–10 cm

**58168V90** 300 pieces



### Natural Cotton Bag Set

For painting or printing

With string pull, Dimensions (W x H): ca. 10 x 11.5 cm

**81278V90** Pack of 24



### Polystyrene Eggs

Dimensions (W x H): 4.5 x 6 cm

**53129V90** Set of 8



### Polystyrene Blocks

Set of 100 white blocks with side lengths 1, 2, 3 and 4 cm. Great for craft projects, can be sculpted, glued and painted.

**88161V90** Set of 100



### Polystyrene Balls

Set of 100 balls: diameter: 30 mm, 50 mm, 60 mm, 70 mm and 80 mm per twenty.

**81790V90** Set of 100



### Bulk Pack: Polystyrene Balls and Eggs

Balls in 4, eggs in 3 sizes, 1.5 to 6.1 cm.

**Content:** 550 pieces: 200 balls diameter: 1.5 cm, 120 balls, diameter: 2 cm, 80 balls, diameter: 3.3 cm, 40 balls, diameter: 4.2 cm. 50 eggs: H: 3.5 cm, 30 eggs: H: 4.8 cm, 30 eggs: H: 6.1 cm.

**56084V90** Set of 550





### MDF Easter Bunny – Set of 3

Bunny themed blank MDF shapes for craft projects. Can be painted individually with wax crayons or tempera.

Dimensions (H x W x D): 15 x 7 x 10 cm

**12417V90** 3 pieces



### Running-In-Circles

Thread in the coloured yarn and create beautiful patterns. Stitch for stitch, children exercise themselves in patience and concentration.

**50552V90** Set with 24 circles, diameter: 15 cm



### Wobbly Eyes

Set of non self-adhesive wobbly eyes with moving pupils. In 4 sizes (diameter: 4, 7, 10 and 15 mm).

Can be used for almost every arts and craft project.

Warning Notice: 43 (page 271)

**55119V90** 200 pieces



### Wild Animal Masks

Little artists adore creating their own animal masks. They love to wear them and play with them.

Set of 8 masks, rubber band included

Warning Notice: 1 (page 271)

**52352V90** Set of 8



### Paper houses for plants

Every child can create its own cress, herb or flower house.

Set of 6 houses with bowl

Height: 20 cm

Delivery without decoration

**12513V90** Set of 6

### Giant Set of Beads

More than 10,000 beads in a wide range of colours and shapes for endless creations! Glittery beads, small-sized or big ones, little hearts, coloured butterflies and stars – they are all suitable for countless handicrafts.

Warning Notices: 1, 5 (page 271)

**81685V90**





### From Cotton Plant to Jeans

Magnetic board material for teaching social studies including textile industry and environment. It is descriptive and easy to understand.

**Content:** 14 magnetic pictures, 12 name cards (printed double-sided English/German), 2 big arrows, 14 small arrows, 8 blanc stripes, 1 instruction manual with master copy

Dimensions of the biggest parts:

Arrow: approx. 16 cm

Name card (W x H): 21 cm, 4 cm

Picture (W x H): 19 cm, 12 cm

**759274V90**



## FROM COTTON PLANT TO JEANS



### Fabric Colour Pens

High colour intensity and perfect for kids.

For drawing on shirts, pencil cases, aprons, kites and so many more fabric items. Dry in 24 hours. Does not wash off and stays on the textile quite a long time.

Contains 10 pencils (white, yellow, orange, rose, red, purple, blue, light green, dark green, black)

Dimensions: diameter: 1.6 cm, length: 11.3 cm

**42164V90**

### Apron

Brightly coloured coverall. With a pocket on the front to store pencils, crayons and paint brushes. With Velcro® fastening. Long sleeves. 100% polyester. Waterproof.

**81883V90** Size S, 2–4 years

**50897V90** Size M, 4–9 years

**82804V90** Size L, 9–12 years



Minimum order: € 400,-



### Rainbow Pencils

Four-colour lead, set of 24 pencils in 2 different designs (stripes and dots)  
Length: 17.5 cm

**759984V90**



### Trays

For various use: Collecting, sorting, painting ... Made of durable plastic. Available in 2 sizes and 5 colours.

Trays, large, dimensions (H x W x D): 4.7 x 23 x 14.7 cm

Trays, small, dimensions (H x W x D): 2.6 x 18 x 12 cm

- 850061V90** Green
- 850060V90** Orange
- 850063V90** Yellow
- 850064V90** Pink
- 850062V90** Blue
- 850108V90** Red
- 850185V90** Purple

- 850056V90** Green
- 850055V90** Orange
- 850058V90** Yellow
- 850059V90** Pink
- 850057V90** Blue
- 850107V90** Red
- 850201V90** Purple

### Set of 6 large trays

- 850112V90** Blue, Pink, Yellow, Orange, Red and Green
- 850212V90** Blue, Purple, Yellow, Orange, Red and Green

### Set of 6 small trays

- 850111V90** Blue, Pink, Yellow, Orange, Red and Green
- 850213V90** Blue, Purple, Yellow, Orange, Red and Green



### Craft Scissors, pointed

Stainless steel, colourful handles, 13 cm  
Assorted colours, 5 pieces each

- 11570V90** Right-handed version
- 11571V90** Left-handed version



### Children's Scissors

Ergonomically designed. Steel blade with plastic handles, 13 cm.

- 9410V90** Right-handed version
- 81548V90** Left-handed version



### Soft Cut Scissors

Soft rubber handle for easy prolonged cutting. Scissors lie comfortably in the hand. With screw for readjustment.

- 81558V90** 15 cm, pointed
- 81559V90** 18 cm, pointed



### Loop Scissors

Self opening scissors for easy cutting. Spring fitted to reopen when pressure is released. Colour can vary.

**81286V90**



### Learning Scissors

A great tool to help guide little hands. Two sets of finger loops so that two hands can hold the scissors. Helps encourage the open and close action required for cutting. Colour can vary.

- 9525V90** Right-handed version
- 52365V90** Left-handed version



### Scissors Rack

Solid wood scissors rack. Holds up to 16 scissors  
Dimensions (H x W x D): 7 x 32.5 x 8 cm

**9503V90**

### Triangle Colouring Pencils

This triangle shaped pencil supports the correct writing and colouring posture, is extra thick and therefore ideal for children's small hands.

#### 1) Round cardboard case with 12 assorted pencils

12462V90 Length: 17.5 cm

#### 2) Round cardboard case with 48 assorted pencils

12463V90 Length: 17.5 cm

#### 3) Wooden case with 144 pencils

Dimensions (W x H): 14.8 x 13.5 cm, assorted

12464V90 Length: 17.5 cm

#### 4) Wooden box with 144 pencils, flat with wooden lid

Dimensions (H x W x D): 4.5 x 37 x 29 cm, assorted

12465V90 Length: 17.5 cm



#### Wooden Case, empty

Dimensions (H x W x D): 8.8 x 14.8 x 13.5 cm

55262V90



#### Electric Sharpener Double-Hole

For regular and jumbo pencils.

Large dust bin for mass storage of sharvings

Powered by 4 type AA (mignon LR6) batteries (not included)

Dimensions (H x W x D): 7.5 x 8 x 10 cm,

Material: plastic

12479V90

755876V90 Spare part sharpener

#### Giant Inkpads

Giant inkpads for creative signs and posters (ink washes right off). Inkpads are 15 cm in diameter, large enough to make hand and feet prints. Perfect for use with the alphabet, number and picture stamps.

All Warning Notice: 9 (page 271)

54275V90 Set of 4 (blue, yellow, green, red)

81533V90 Set of 3 (yellow, blue, red)

Minimum order: € 400,-



#### Sidewalk Chalk

Length: 10 cm, in bucket with lid

All Warning Notice: 2 (page 271)

54835V90 Set of 50

54834V90 Set of 20





**NEW**



**NEW**



**Cross Body Bag**

Trendy bag for carrying on hips, chest or stomach. Has zippers on front and backside. Strap is variable in size.  
**761591V90**

**Cotton Bib**

Perimeter neckline: approx. 36.5 cm  
 Size: approx. 22.5 x 29.5 cm  
 Material: 100% cotton  
**761613V90**

**Cotton Sun Hat**

Size: 54, Height: approx. 8.5 cm (without brim)  
 Material: 100% cotton  
**761589V90**

**Adult Apron**

With hook-and-loop neck (67 cm) and waist straps (80 cm each).  
 Dimensions (W x H): 62 x 92 cm  
 Material: 100% polyester, washable at 30 °C  
**56137V90**

**Coated Tablecloth**

Protects your table, easy to clean  
 Material: 100% polyester

**53470V90** 120 x 120 cm

**53469V90** 160 x 120 cm

### Giant Loom

Optimal size for first weaving efforts. Use wool, cloth and different fabrics or natural materials. The stringed loom is adjustable in height.

Dimensions (H x W x D): 40 x 64 x 125 cm

Comes with 2 wooden shuttles, 4 balls of wool

81674V90



### Weaving Combs

Weaving with wool is a fun way to help develop the fine motor skills of children. In no time, colourful carpets or window pictures are created.

This set consists of 5 blue plastic web combs. The fabric is pushed back very easily and thus creates a consistent final result. Dimensions (H x W x D): 15.5 x 3.8 x 0.4 cm

12534V90

### Small Loom, 16.5 x 22 cm

Weaving amplitude about 14 cm, solid beech construction with 17 ribs.

Comes with: 1 wooden slide, 1 comb

56314V90

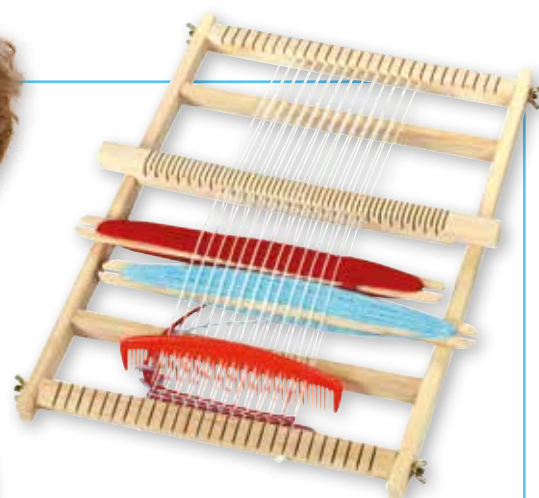

### Big Loom, 30 x 40 cm

Content:

2 shuttles, 2 combs (to attach and to turn-over)

50998V90

# SPORTS & GAMES



## Football Set

Specially for your needs

### Content:

8x school football (34276V90)

2x match football (34277V90)

1x soft-indoor football (34279V90)

1x mesh bag (3469V90)

**33118V90** Set



## School Football

Best school quality, carefully hand-stitched.

Low-priced training football in official size and weight.

Blue

**34276V90** Size 5



## Training Football

Excellent training football for a good price value.

Shape-retaining with an abrasion-proof, water-repellent surface. Official size and weight.

Red

**34275V90** Size 5



## Match Football

Great match football for all kinds of games and matches regardless of weather conditions or tournament locations. Size and weight according to FIFA guidelines.

32 panels, carefully hand-stitched, grey

**34277V90** Size 5





### School Basketball

Perfect ball for training with an excellent price-performance-ratio. Good bouncing characteristic with handy surface.

Size 5, circumference 69–71 cm, weight: 470–500 g  
**754873V90**



### Basketball

Training ball – very easy to grasp. Nylon cover. Very good bounce.

**754445V90** Size 5  
**756207V90** Size 7



### Basketball Junior

Very handy thanks to its burred surface. Lightweight (only 290 g)

Material: plastic, diameter: 20 cm, perimeter: 66 cm  
**760879V90** Size 4



### Coated foam Football

Balls can be used for any activity. Use indoors and outdoors. A great substitute to harder rubber or synthetic footballs. Made of polyurethane

**33200V90** Size 4, Ø 20 cm, 400 g, Age: 24 M+  
**33915V90** Ø 15 cm, 130 g



### Schoolyard Football

Perfect for playing indoors and outdoors. The football is high quality and made of resistant rubber.

Diameter: 22 cm  
**757112V90** Size 5



### Football, Rubber

Unique sturdy football. Ideal for all surfaces and all weather conditions. Vulcanised rubber with grained surface.

Size 5  
 Diameter: 22 cm  
 Weight: 470 g

**34170V90** Yellow/red  
**756128V90** Blue/red



### Football Softball

An ideal football for children and young students. Regular size football, but its weight is reduced to 200 g.

Green  
**34274V90** Size 5



### Soft-Indoor Football

Suede-like material cover, especially durable bladder and carefully manufactured to suit tight conditions of indoor football. For indoor football only!

Yellow/grey  
**34279V90** Size 5



### Indoor Football

This football is made of high-quality felt and is perfect for playing conditions of indoor football. Thanks to excellent quality this ball meets the highest standards.

Yellow  
**34280V90** Size 5



### Soft Ball Bounce

An exciting alternative to hockey!  
Soft bats and soft ball are made of foam skin.

**Content:** 6 sticks – 3x red and 3x blue, length: 80 cm  
1 ball – diameter: 13 cm

**33189V90**

**33915V90** Replacement ball



### Ball-Bounce

Ball-Bounce, set with 6 rackets and one ball

A new way for familiar games to be played. This fast game for nimble students can be played on the floor and in the air – possible due to the soft head of the racket and the small plastic ball. The rackets offer different versions of the game, e.g. hockey, tennis or badminton in a new way. All of the games stimulate the reaction, the coordination, the hand-eye-coordination and the movements of your students.

**Content:**

- › 6 rackets (3x blue, 3x red)
- › ball

**3949V90**



### Easy Grip Balls

Set of four colourful balls with a ribbed effect surface that helps the children catch and throw. The balls are sturdy and have a perfect size for kids.  
In the colours red, green, blue and yellow.

Set of 4: diameter: 9 cm, 12 cm, 16 cm, 20 cm

**758159V90**



### Unihockey Set

Sturdy hockey sticks made of particularly unbreakable plastic – ideal for use both indoors and outdoors (on grass). The rackets have a shaft length of 80 cm and are suitable for children and adolescents up to a height of 160 cm.

The set includes 12 sticks and 12 balls, so each player can practice with his own ball.

**Content:**

- › 6 sticks with a red shovel
- › 6 sticks with yellow shovel
- › 12 balls (diameter: 7.2 cm)

**3570V90**

### Set of 10 Soft Volleyballs

Great for younger children. Soft enough to be tossed or thrown without the fear of painful impact, these yellow volleyballs are made of high-density foam, and feature a soft coating for durability. Diameter: 20 cm, Weight: 32 g Set of 10. Comes in a ball net

**100612V90** Set of 10

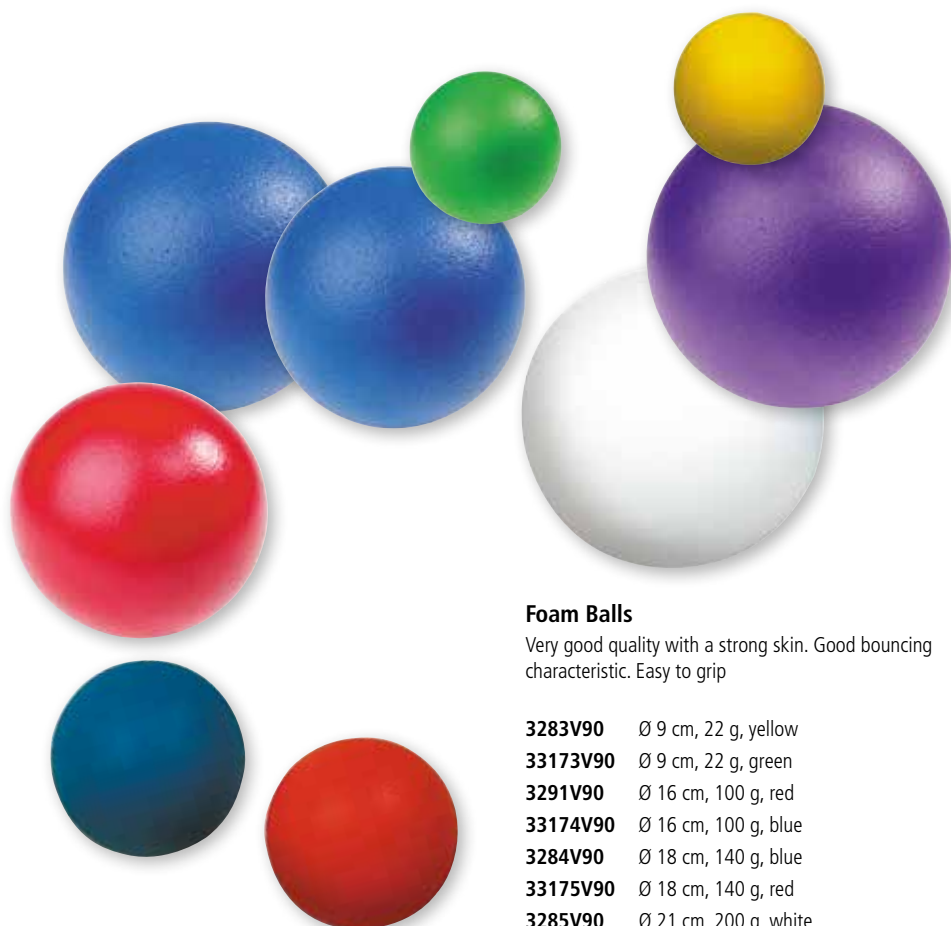

### Foam Balls

Very good quality with a strong skin. Good bouncing characteristic. Easy to grip

- 3283V90** Ø 9 cm, 22 g, yellow
- 33173V90** Ø 9 cm, 22 g, green
- 3291V90** Ø 16 cm, 100 g, red
- 33174V90** Ø 16 cm, 100 g, blue
- 3284V90** Ø 18 cm, 140 g, blue
- 33175V90** Ø 18 cm, 140 g, red
- 3285V90** Ø 21 cm, 200 g, white
- 33176V90** Ø 21 cm, 200 g, violet

Minimum order: € 400,-



### Lightweight Volleyball

Exercise ball with a clearly reduced weight (200–220 g) in official size. Slower floating, and easier to volley – perfect for beginners. With hand sewn soft polyurethane-cover.

**34282V90** Size 5



### Beach Volleyball Sport

Durable ball for a good price value. The special synthetic leather cover offers a soft touch and excellent grip and is therefore ideal for beginners. For all weather conditions, shape retention and durable. 18-panel hand sewn construction. Official size and weight.

**34281V90** Size 5



### Training Handballs

Specially designed and extremely popular with schools! The ball is extremely smooth but sturdy and super to grip.

- 3849V90** Mini Size 0
- 3848V90** School Size 1

## Foam Balls

Very good quality with a strong skin. Light bouncing, easy to grasp. For indoor and outdoor use.

Diameter: 15 cm, weight: 65 g

- 33195V90 Red
- 33196V90 Blue
- 33197V90 Yellow
- 33198V90 Green
- 33199V90 Purple
- 33993V90 Orange
- 33992V90 Pink



## Football Billiard Set Size 4

Football Billiard is a combination of billiard and football – it's fun because you get to kick the balls into pockets instead of using a cue stick. This game demands a mix of feel for the ball and provides a lot of fun. It is perfect for warm-ups or team games.

A set consists as real billiard from seven "half", seven "solid" and the black "8". The white "ball" is in difference to the numbered balls with reduced bounce. As sidelines you can use any existing gymnastic bench, outdoor bench etc.

**Content:**  
15 coloured balls, 14 white ball, 1 net  
**34382V90**



### Tennis Ball

Diameter: 6 cm,  
weight: 60 g  
**33211V90**

### Soft Football

Suitable for gym and lawn  
Diameter: 20 cm,  
weight: 320 g  
**35451V90**

### Soft Volleyball

Suitable for gym and lawn  
Diameter: 20 cm,  
weight: 320 g  
**35452V90**

### Soft Tennis Ball, coated

Diameter: 9 cm, weight: 45 g  
**33357V90**



### Safe-Keeping Ball Net

Perfect for transport and storage.

- 3468V90** Net for 6 balls
- 3469V90** Net for 9–12 balls

### Ball Net with Collecting Ring

Up to 20 balls (size 5) can be stored in this sturdy net. The handy ring ensures a quick and easy collecting.

**36285V90**



### Bouncing Balls

These fantastic rubber bouncing balls are perfect for jugglers. They feel great in your hands. Easy to clean with soap and water.

Set of 6 balls in 6 colours. Diameter: 6 cm

**754465V90** Set of 6



### Fun Ball

Excellent bouncing ball, but never in the direction you expect it to!

Particularly good for circle and group games.

With needle valve for inflation.

Diameter: ca. 20 cm, weight: 190 g

**36236V90**



### Jingle Ball

Roll or throw the ball. Inside are 3 jingles which you can hear loud and clear. This offers a variety of new ball games including the sense of hearing. Age: 12+

Diameter: 15 cm, weight: 240 g

**33916V90**



### Kooshie Bounce Ring Set

Bounce the balls back and forth as many times as possible, or create your own game. This is fun and trains eye-hand coordination.

**Content:**

2 large plastic rings with a bouncy fabric, diameter: 35 cm

2 koosh balls, diameter: 5 cm and diameter: 11 cm

Warning Notice: 1 (page 271)

**36368V90**



**BEST  
SELLER**

### Koosh Ball

The special form of the ball gives the children a complete new sensation. Per piece

All Warning Notice: 1 (page 271)

**33256V90** Mini, ca. 5 cm

**3676V90** Small, ca. 8 cm

**3674V90** Large, ca. 11 cm



### Tail Ball

Soft leather-like ball with a colourful tail. Can be used for different catch-games – the tail gives an extra chance of catching.

Weight: 90 g, diameter: 6.5 cm, Length of the tail: 95 cm

Material: 100% nylon

**33269V90**



### Colourful Tail Balls

Easy to catch! Set of 6 big colourful balls.

Diameter: 10 cm, weight: 110 g, weight tail: 80 cm

Material: 50% polyester, 30% cotton, 20% synthetic leather

**34202V90**



### Badminton School Set

This set offers the possibility to get familiar with badminton at a sensational price.

Includes 12 steel rackets (weight: 125 g) with a synthetic grip and 12 yellow nylon shuttles. Ideal for juniors and beginners.

**35478V90** Set



### Badminton Bag

Large-sized bag for rackets and balls. 100% nylon. Dimensions (H x W x D): 33 x 66 x 28 cm

**35488V90**



### Smash Ball

Interesting game for children and adults. Rackets have short handles. So also younger children can easily play. Chances to hit the ball are much higher. Everybody will have fun.

**Set with 2 Rackets** (Length: 47 cm) and 2 colourful Smash Balls

**33068V90**

**Extra Smash Balls** – 6 pcs., Set of 6 balls

**33812V90**



### Shuttlecock Tennis

Set of 2 plastic rackets and 2 balls. Diameter: 23 cm, length: 38 cm

Warning Notice: 1 (page 271)

**33401V90**

### Replacement Feathers for Both Shuttlecocks

Warning Notice: 1 (page 271)

**33403V90**

### Table Tennis Outdoor Set

The perfect table tennis equipment for the schoolyard. Set includes 5 outdoor table tennis paddles (36307V90) and 10 balls (34015V90) and comes with a practical storage box (77666V90).

100314V90



### Outdoor Table Tennis Racket

Weatherproof racket made of durable plastic. Ideal for outdoor use. With rubber pad and riffled handle.

Length: 25.5 cm

36307V90

### Table Tennis Racket "Flash"

Specially designed for beginners. Surface on both sides guarantees a perfect control.

Size of the head: 15.3 x 15.7 cm

Grip length: 10.4 cm

Colour: one side red, one side black

Thickness: 0.8 cm

34436V90 1 racket

34437V90 Set of 10



### Bouncing Ball

Try to catch the soft ball with the net and throw it back to your partner. With some routine you can play an exciting match developing your aiming skills.

**Content:** 2 nets with padded plastic handles, 1 ball

Warning Notice: 1 (page 271)

33535V90

### Table Tennis Racket "Smash"

Specially designed for beginners. Surface on both sides guarantees a perfect control.

1 mm sponge on both sides

Size of the head: 15.5 x 15 cm

Grip length: 10.2 cm

Colour: one side red, one side black

Thickness: 1.1 cm

759442V90





### Bubble Ball

Solid rubber ball with 6 bubbles. Bounces can be dramatic and erratic. Ideal for eye-tracking and coordination.

All Warning Notice: 1 (page 271)

**35487V90** Small, 7 cm, 70 g

**35485V90** Big, 10 cm, 230 g

### Jumbo Reaction Ball

You need concentration and reaction to catch this crazy foam ball. Diameter: 24 cm, weight: 330 g

Warning Notice: 1 (page 271)

**33753V90**

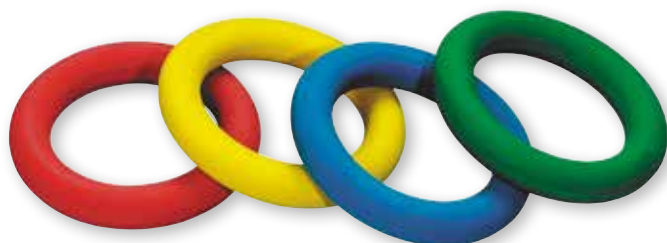

### Soft Tennis Ring

The soft tennis rings are made of shape retaining durable sponge rubber.

They can be used in many games, they even make excellent water toys.

Diameter: 16.5 cm, weight: 200 g, in assorted colours

**3709V90** 1 piece

### Bungee Football

When you kick the ball it comes right back to you! Bungee football allows continuous training without having to chase the balls.

Ball: 20 cm

Warning Notice: 4 (page 271)

**33534V90**



### Velcro® Ball Game

Two plates covered with Velcro®.

The ball sticks to the plate. Children will develop their aiming skills.

Set: 2 plates, diameter: 20 cm and one ball

Warning Notice: 1 (page 271)

**33272V90**



### Rugby Ball

Surface made from durable synthetic leather, multi-layered, can also be used for American football.

Dimensions: 28 cm, weight: 350 g

**36355V90**



### Soft Frisbee

Soft foam disks in bright colours. Sturdy skinned.

Easy to catch and easy to throw.

Size: ca. 21 cm, weight: 95 g

In assorted colours.

All Warning Notice: 1 (page 271)

**33188V90**

**759243V90** Set of 6 soft frisbees



### Flying Torpedo, soft

The throwing torpedoes have a very soft foam shell and you never miss your target. Excellent flight characteristics makes this torpedo special.

All Warning Notice: 1 (page 271)

**35436V90** 20 cm, 65 g

**35437V90** 26 cm, 125 g

**35438V90** 37 cm, 230 g



### Mega Howler

This aerodynamic ball can be thrown a long distance and howls while flying through the air!

It is perfect for outdoor play, durable but soft enough for easy catches.

Length: 31 cm, weight: 125 g

**36366V90**

### Flying Whistle Ball

Tough, durable and simple to throw and catch, the Flying Whistle Ball is a great outdoor throw around toy. As it flies, the whistle sound adds to the fun.

**755684V90**

### Emotion Balls

Very attractive balls for children. 6 balls showing different emotions. To be used in activities for pretend play, evaluations ... Age: 24 M+  
Diameter: 15 cm

**33692V90** Set of 6 balls



## TRY TO CATCH THE BALL



### Number Ball

Try to catch the ball. The number on the arm you are holding is your score. Continue the game and keep on adding the numbers on the arms.

Diameter: 30 cm

Warning Notice: 1 (page 271)

**3144V90**



### Soft Shuttlecock Game

This lightweight, soft foam head allows young children to play using hands or rackets.

Weight: 25 g – length: 30 cm

Warning Notice: 1 (page 271)

**33402V90**





### Catch Ball

Game for the promotion of throwing and catching skills, coordination and concentration.

Different difficulty levels and game variants.

Dimensions: assembled: 77 cm, hemisphere Ø 13 cm, edge 1 cm thick, Ø sphere green: 10 cm, Ø sphere blue: 7.5 cm. Material: plastic, foam

**758709V90**



### Rainbow Rings

The 6 short rainbow-coloured ropes are made of 100% cotton. Each rope has a diameter of 14 cm. The ends are fixed with metal. The diameter of the ropes is 1 cm.

**757859V90**



### Swing Loop

The aim is to get the ball in the loop. To stimulate the child's eye-hand coordination.

**36198V90** Size 1: Length: 25 cm, Ball: Ø 3,5 cm  
Warning Notices: 1, 4, 5 (page 271)

**33513V90** Size 2: Length: 38 cm, Ball: Ø 6,5 cm  
Warning Notices: 1, 4 (page 271)



### Pitch the Rings

This popular game is made from a very soft material. You can store the separate parts even in the smallest bag. So you can take them easily with you on school excursions.

**Content:** 6 rings (Ø 12 cm) and 1 pitch-station (13 x 42 x 42 cm)

All Warning Notice: 1 (page 271)

**754398V90**

**36344V90** Set with 6 Spare Rings

### Flying Ufo Set

Put the 6 poles according to your desired position. Spin the flying UFO to knock poles down. Score will be counted by knocked-down poles.

**Content:** 6 poles + 2 flying UFOs  
Height poles: 27.5 cm. Ø UFO: 12.5 cm

Warning Notice: 1 (page 271)

**36279V90**

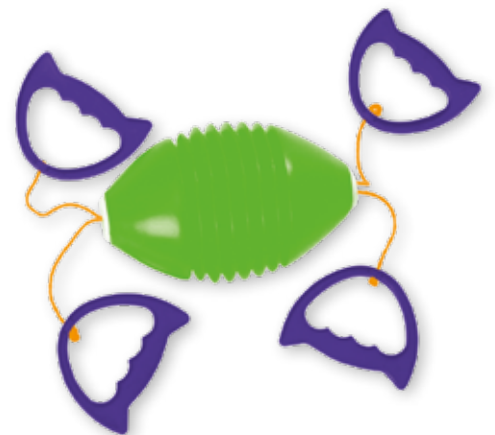

### Swoosh Ball

The all time favourite is back! Just grab the handles, walk away from your partner until the ropes are taut and then "swoosh" the shuttle from one end to the other by moving your arms outward. Great fun for pairs of children! Helps to build coordination and arm strength.

Dimensions: ball: 20 x 13 cm, cords: 220 cm

Warning Notice: 4 (page 271)

**100286V90**



### Soft Bowling

Great fun to practice a bowling game before going to the real lanes. A set contains 10 pins and 2 balls with finger holes. All components fully covered by high density rubber foam.

It is suitable for both indoor & outdoor activity.

#### Content:

10 pins, height: 29 cm, 2 balls Ø 16 cm, 1 bag

Warning Notice: 1 (page 271)

**36238V90**



### Horse Game

The size of the harness is freely adjustable.

The snap-closing in the front can easily be opened if "the horse" wants to free itself.

100% nylon

Not to be used on playground equipment!

All Warning Notice: 52 (page 271)

**36219V90** Red

**760448V90** Blue



### Toss Set

Set of 10 tins and 6 balls made of soft material.

Makes no noise.

Dimensions: tins: height: 10 cm, Ø 8 cm, Balls: Ø 6 cm

Warning Notice: 1 (page 271)

**36220V90**



### Mini Soft Bowling Set

Have great fun with this small version of the famous bowling game in assorted colours. All components are covered by soft rubber foam and therefore safe for children.

#### Content:

6 pins (17 cm height, Ø 5.5 cm), 1 bowling ball (Ø 9.5 cm) and 1 position mat.

Warning Notice: 1 (page 271)

**34119V90**



# BALANCING GAME



## Balancing Game

Try to run without losing the ball.  
Set of 2 platforms (Ø 15 cm) with handle and 2 balls.  
Warning Notice: 1 (page 271)

**36280V90**



## Baseball Starter Set

The foam covered baseball bat and ball make a great starter kit for youngsters learning to hit. The pleasantly soft grip makes the bat extremely slip proof.

Bat: Diameter: 7 cm, length: 61 cm

Ball: Diameter: 8.8 cm

Warning Notice: 1 (page 271)

**34128V90**

## Balancing Game Ice Cream Ball

2 ice cream waffles and 12 ice balls for balancing games.

Promotes concentration and coordination.

Dimensions: ice ball: diameter: 5.5 cm, height: 5.5 cm, waffle: diameter: 6.5 cm, height: 11 cm, Material: foam

**758710V90**

## Easy Catch Ball

With this smooth grid ball children practice and improve their throwing and catching skills.

Diameter: 17 cm, made of coated plastic tapes

**34201V90**



## Balancing Bunny

Try to move the ball on top of the stick as fast as you can without dropping it. A real challenge that requires concentration and a sense of balance. Stimulates the eye-hand coordination.

**Content:**

2 balancing sticks (37.5 cm) with balls (Ø ca. 7 cm)

Warning Notice: 1 (page 271)

**34129V90**



## Maxi Flying Disc

An extra-large disc for maximum play fun! This light-weight made of elastic fabrics with an upholstered smooth rim can even be thrown by smaller children.

Diameter: 44 cm, weight: 150 g

**33909V90**



### Safety Dart Game

The set includes six safety darts and a 42 cm diameter dart board with a hanger hook. It also includes a metal table stand so this safe game can be used anywhere. Great fun for children.

Warning Notice: 27 (page 271)

**33595V90**

### Replacement Darts

All Warning Notice: 27 (page 271)

**34268V90** Green

**34269V90** Red



### Velcro® Target Game

Throwing game which develops the accuracy. Set contains a bag, an inflatable cushion and three balls. The inflatable cushion is placed in the bag during the game. After the game the cushion can be deflated and stored into the bag.

Size of inflated cushion: Ø 65 cm

Warning Notice: 1 (page 271)

**50476V90**

### Extra Balls

Weight: 60 g, diameter: 6 cm

Set of 3 balls

Warning Notice: 1 (page 271)

**33811V90**



### Sack Race Bags

To enhance the development of balance. Supplied in 2 different colours. Very sturdy and well finished. Material: 100% nylon. All Warning Notice: 1 (page 271)

**Junior size:** height: 60 cm – hop surface: 25 x 25 cm

**33342V90** Red

**33343V90** Blue

**Senior size:** height: 90 cm – hop surface: 35 x 35 cm

**33344V90** Red

**33345V90** Blue



### Balance Wall

The stones are 12 cm wide and stand firm and solid. On the other side the balance path is only 5 cm wide. Balancing is really a challenge. To connect the parts just push them together. This way the children can always create new forms and paths.

The 27 parts made of high shock-resistance plastic are each 10 cm high. Complete length: approx. 7.5 m. Warning Notice: 3 (page 271)

**33761V90**



### Colourful Can Stilts

For games and races of sports and fun. Support the motor activity of the kids with balance and craft exercises.

Made of sturdy plastic (height: 12 cm, Ø 9.5 cm) with tear proof holding rope, load capacity: 50 kg

All Warning Notices: 3, 4 (page 271)

**33329V90** Blue, Red, Yellow

**850102V90** Pink, Orange, Green

**850214V90** Purple, Limette, Petrol

### Round Balancing Board

Children develop their motor skills and balancing abilities. For rocking from side to side and balancing.

Children can stand or sit on the board. With a sensory stimulation surface on the top, and an anti-slip surface on the bottom that prevents slipping on smooth floors.

**33413V90**



### Target mat

Aim well and score! Throw your bean bags on the target mat and add your points. Who is the winner?

Target mat made from plastic foil, sturdy and tearproof, 1 square metre, 8 bean bags in 4 colours

Warning Notice: 1 (page 271)

**36258V90**

### Play and Fun Set

Red bin on wheels with lots of different items for playing and sports indoors and outdoors for at least 80 kids over 4 years.

For different kinds of sports, such as throwing, jumping, catching and many more. Includes the following components: 8 skipping ropes – assorted colours

– 2.50 m, 100% polypropylene

3 swinging ropes – 5 m, 100% polypropylene, 4 sensorimotor balls, 3 coloured rubber twist – 5 m, 2 soft footballs, 4 juggling plate with rod, 3 soft throwing discs, coated (Ø 21 cm), 4 foam rubber rings, 2 centrifugal balls, 2 velcro ball games, cover 100% nylon, 2 Scoop-Ball Games, 3 mini badminton sets, 4 horse harnesses, 100% nylon

Warning Notices: 1, 4, 52 (page 271)

**100198V90**



### Multipurpose Bag

This colourful bag is suited to store all small parts needed in sports lessons. (Bean bags, jump ropes, team ribbons ...) Capacity: 14 l

36298V90



### Chinese Elastics

Elastic jump rope with a frog shaped holder.

Length: 2.55 cm

Warning Notice: 4 (page 271)

35417V90

### Viking Game

The Viking Game is a Scandinavian outdoor skill and throwing game for 2–12 people. Ideal for the playground or school trip.

Skill, concentration, strategy and of course unerring throwing are required here.

It is played outdoors, it requires a relatively flat surface of approx. 5 x 8 m.

For 2–12 players

21 pieces made of solid wood

Warning Notice: 2 (page 271)

42576V90



### Box Set Champion

All you need for practising boxing! This complete training kit includes a 9 kg heavy sturdy punching bag and a pair of boxing gloves with variable hook-and-loop fastener.

One pair of boxing gloves, size 8 oz

Punching bag with belt suspension and ferrule,

Diameter: 20 cm, height: 75 cm, weight: approx. 9 kg,

material: 100% polyurethane

For youngsters (10 years and up) and adults

34183V90



### Tic Tac Toe

Children love the giant version of this classic game. It is easy to play: Winner is who succeeds in laying three tiles in a row (horizontal, vertical or diagonal).

**Content:** 11 parts:

1 playing grid field, 1 x 1 m

10 playing tiles, 5x blue and 5x red,

diameter: 23 cm

Warning Notice: 1 (page 271)

34208V90





### Soft Fibre Skipping Ropes

The soft fibre skipping ropes can be used in any sports lesson. Each rope is 2.80 m long and has a diameter of 1 cm. Therefore, it is consistently strong and allows easy jumping. The rope can be used for playing, for gymnastics- or dancing-choreographies, for gymnastic or for strength- and endurance-exercises. For washing use gentle cycle at 30 °C. Do not tumble dry it in the rotary dryer.

- 757749V90** Set of 6, nature
- 757750V90** Set of 6 in 6 colours



### Short Ropes Rainbow Set

The 12 short rainbow-coloured ropes are made of 100% cotton. Each rope has a length of 40 cm. The ends are glued. The diameter of the ropes is 1 cm. Possibilities of stimulation:

- > motor activity
  - > coordination
  - > patience
  - > concentration
- Scope of delivery: 12 colourful short ropes
- 757751V90**



### Skipping Ropes

Sports alternative for the jump rope.

With these ropes you can make the most difficult figures and combinations. Ropes in bright colours with fixed handles, allowing the rope to turn.



Length: 3 m

- 3511V90** Yellow
- 33095V90** Blue
- 3513V90** Pink
- 33096V90** Green

Lengths – ideal for youngsters  
Length: 2.43 m

- 3514V90** Yellow
- 3028V90** Blue
- 3516V90** Pink
- 3029V90** Green

Length: 2.73 m

- 3543V90** Yellow
- 3138V90** Blue
- 3545V90** Pink
- 3139V90** Green

**BEST  
SELLER**

# JUMP ROPEs

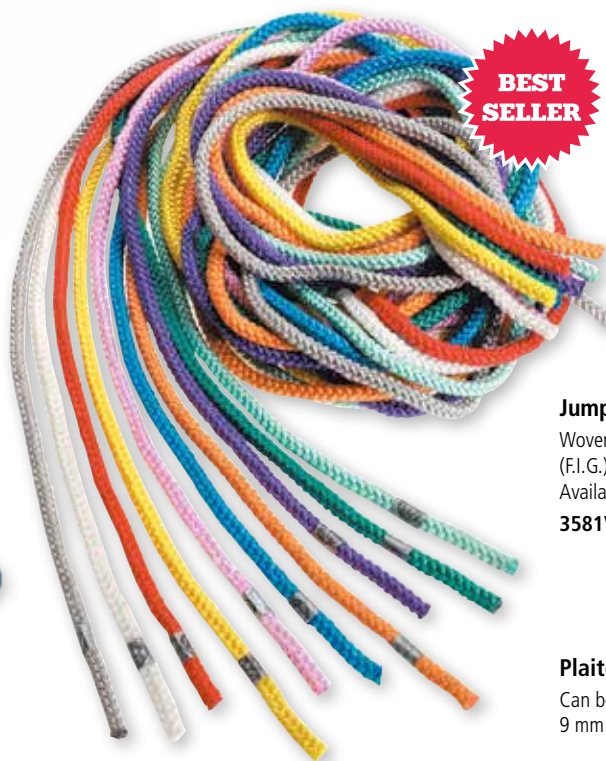

### Jump Ropes

Woven in accordance with international regulations (F.I.G.). Dimensions: 3 m long, 9 mm thick. Available in bright colours.

- 3581V90** Set of 10 pcs.

### Plaited Ropes

Can be used in different areas of sports and games. 9 mm thick

- 3583V90** Length: 8 m pink
- 3584V90** Length: 10 m green
- 3585V90** Length: 15 m blue



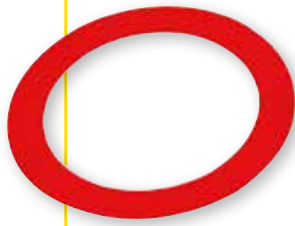

### Juggling Rings

Good flight performance. Very interesting material to juggle.

For beginners and for experienced jugglers.

Diameter: 24 cm

Weight: 70 g

**3510V90**

### Balancing Plate

Colourful plate – made of high quality plastic.

Diameter: 22 cm, weight: 70 g, supplied with plastic stick.

**3490V90**

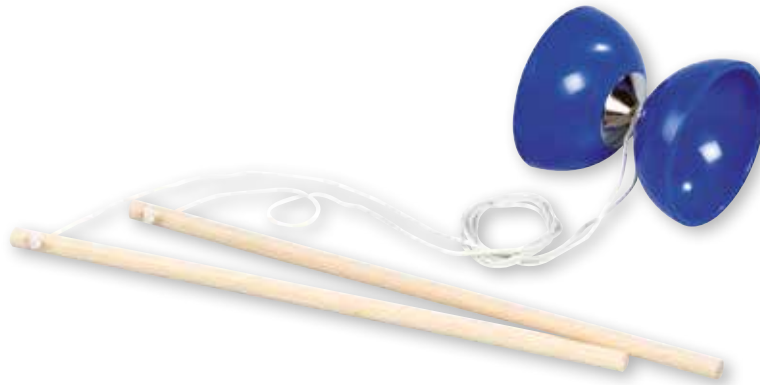

### Diabolo

Wooden sticks and colourful spool.  
To develop motor abilities.

Diameter: 10 cm, weight: 165 g

**3489V90**



### Bean Bags

Made from strong cotton with a safe non-toxic filling.

All Warning Notice: 1 (page 271)

**Weight: ca. 80 g, dimensions: 8 x 14 cm**

**3717V90** Yellow

**3719V90** Blue

**3718V90** Green

**3720V90** Red

**Weight: ca. 120 g, dimensions: 15 x 10 cm**

**3793V90** Red

**3795V90** Green

**3794V90** Yellow

**3796V90** Blue

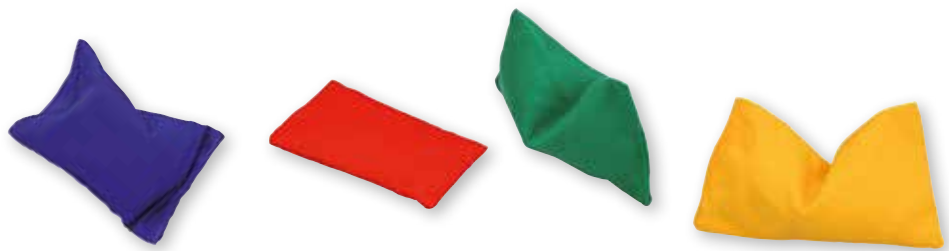

### Juggling Balls for Kids

Suitable for small children

Diameter: 5 cm, weight: 50 g

Warning Notice: 1 (page 271)

**50060V90** Set of 3 pieces



**BEAN BAGS**  
IDEAL TO CATCH, THROW AND FEEL;  
ATTRACTIVE PRODUCT FOR MANY  
ACTIVITIES.



**Rainbow Rhythm Ribbons**

Colourful ribbons with sturdy plastic wands.

**33448V90** Ribbon: length: 2 m, plastic wand: 30 cm

**33449V90** Ribbon: length: 3 m, plastic wand: 40 cm

**Coloured Rhythm Ribbons**

Width: 5 cm

Ideal resources for children to make beautiful patterns while they wave and dance.

Special handles prevent tangles while the ribbons encourage creative movement.

**3174V90** Set 1: 5 Ribbons in 5 colours, 1.6 m long

**3175V90** Set 2: 5 Ribbons in 5 colours, 3 m long

**Double Rhythm Ribbons**

2 colourful ribbons attached to each plastic wand.

Ribbon movements have a more intense effect.

Ribbon: length: 1.8 m

Plastic wand: length: 23 cm

Set of 6 double rhythm ribbons in 6 colours

**33450V90**

**Rhythmicity Flags**

With grab loop and weight bags for smooth movements and excellent drives.

Set of 4 flags in 4 colours, dimensions: 48 x 48 cm, weight: 65 g, 100% nylon

Warning Notice: 1 (page 271)

**33901V90**



## Rhythm and Movement Set

### Content:

- 10 jump ropes
- 6 double rhythm ribbons
- 10 scarfs
- 4 balls
- 2 pair of claves
- 4 hand bells
- 4 egg shakers
- 1 hand drum
- 1 headless tambourine
- 1 triangle
- 1 bag (100% Polyester)
- Warning Notices: 1, 43 (page 271)

53500V90

**BEST  
SELLER**



### Mystery Balls

Bag made of cotton to put a balloon in. Through a small hole in the bag a balloon is inflated to create a colourful ball. As light as a balloon. But with a different pattern of flying. Supplied with 3 balloons. Diameter 25 cm, Material: 100% cotton  
Warning Notices: 1, 6 (page 271)

758327V90 Dots

758328V90 Stripes



### Body Sack for Dancing

Fantasy and fun in experimenting are encouraged with these body sacks. The Velcro® on the back allow an easy to-get-in and -out. High elastic fabric, permeable to light and air.  
Material: 80% Nylon, 20% Elastane  
All Warning Notice: 1 (page 271)

#### Size L:

Dimensions (W x H): approx. 70 x 140 cm (6 – 12 years)

33418V90 Blue

33419V90 Red

#### Size XL:

Dimensions (W x H): approx. 70 x 155 cm (for 13 years and up)

33420V90 Blue

33421V90 Red

### Jumping Sacks

Ideal for sack races and equilibrium training  
High quality material, tear-resistant handles made from webbing  
Material: 100% Nylon  
All Warning Notice: 1 (page 271)

760441V90 Blue/green

760449V90 Purple/red



**NEW**



### Parachute Elongate

An extraordinary shape for a variety of funny games. All depends on team spirit, cooperation and coordination!

Ideal for active games and rhythmic exercises.

Dimensions (L x W): 8 x 1 m with 17 handles,

Material: 100% polyester

**34207V90**



### Parachute Team Game

With the big scarfs the big ball can be played in different directions. To accomplish this you need to cooperate as a team, because you have to decide in which direction to play the ball.

The ball is pumped up with a hair dryer or a compressor. On each sturdy scarf there are 6 loops, so 9 pupils can play at once.

#### Content:

3 colourful scarfs, diameter: 140 cm, assorted

1 ball, diameter: 60 cm

Material: 100% nylon

Warning Notice: 1 (page 271)

**754358V90**

## Parachutes

To encourage non-competitive group cooperation.  
To refine motor skills and develop a sense of rhythm.  
Can be used in- and outdoors.  
Manufactured from washable ripstop nylon (100%),  
reinforced handholds, in a handy bag.  
Available in 4 sizes.

- 3217V90** 1.80 m Ø, 12 handles
- 3196V90** 3.60 m Ø, 12 handles
- 3197V90** 6.10 m Ø, 16 handles
- 3205V90** 7.30 m Ø, 20 handles

## Scarfs

Very light scarves, but also very robust. Using scarves in  
music lessons helps children to learn and practice rhythm  
by transferring music into movement.  
Made of 100% nylon. Assorted colours. Age: 24 M+

- 35935V90** Set of 10 Scarfs, 40 x 40 cm

### Single colours in sets of 10, 40 x 40 cm

- 55953V90** Yellow
- 55950V90** Purple
- 55949V90** Orange
- 55958V90** Blue
- 55952V90** Dark Blue
- 55954V90** Red
- 55957V90** Pink
- 55955V90** Light Pink
- 55951V90** Green
- 55956V90** Light Green



### Single colours in sets of 5, 65 x 65 cm

- 33518V90** White
- 33519V90** Yellow
- 33520V90** Orange
- 33522V90** Red
- 33521V90** Pink
- 33523V90** Green
- 33524V90** Blue
- 33525V90** Black
- 3497V90** Set of 10 scarfs, 65 x 65 cm
- 33400V90** Set of 10 scarfs, 140 x 140 cm

All Warning Notice: 1 (page 271)



## Sunflower Parachute

Add variety to your parachute activities with the sunflower  
parachute: Roll the ball along each arm in a team  
game. Made from 100% nylon and supplied in a bag.  
2 strong handles on each arm allow for up to 16 children  
to play. Diameter: 3.5 m

- 33994V90**

Minimum order: € 400,-





### Parachute "Stars in Heaven"

Big parachute, that makes children play and dream. Can also be used as a decoration.

Diameter: 5 m  
Comes in a bag  
**35645V90**



### Large Foam Dice

3 uncoated dice in the colours yellow, blue, red in a practical net.

Dimensions: 16 cm

**757373V90**

### Cones with Numbers

These cones are an excellent teaching and organisation tool. The cones are numbered 0–10. For indoor or outdoor use. 23 cm

**33507V90**



### Barefoot Balls

Super soft foam balls which can be used for barefoot football. 3 pieces (yellow, blue and red in a ball net). Material balls: 100% polyurethane

**34139V90** Small, Ø 12 cm

**34138V90** Large, Ø 20 cm



### Pompons

For small cheerleaders

Dancing is even more fun with the pompons! With the sturdy two-finger plastic handle the pompons can almost be held invisibly! Your pupils will develop new dances and choreographs with enthusiasm.

Each 1 piece.

All Warning Notice: 1 (page 271)

**54501V90** Pompon Yellow, Large, 130 g

**54499V89** Pompon Red, Large, 130 g



### Tug of War Rope

Ideal for summer events, shows and school sports days.  
 Length: 10 m, Diameter: 2 cm, Capacity: 2.5 t  
 Made of 100% polypropylene  
**34058V90**

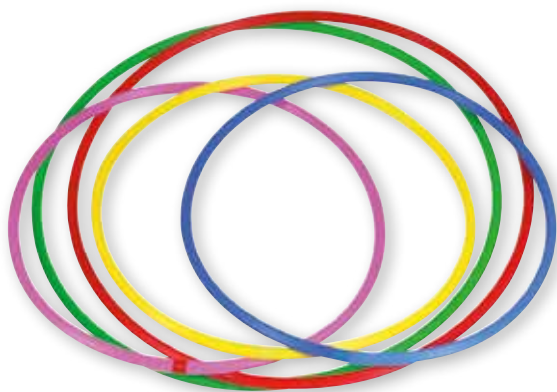

### Gymnastics tires

A classical playing equipment which excites children again and again. Children make up new games with this sturdy hoop. Assorted colours

- 759328V90** Ø 60 cm, blue
- 759329V90** Ø 60 cm, green
- 759330V90** Ø 60 cm, yellow
- 760110V90** Ø 60 cm, red

- 759331V90** Ø 80 cm, blue
- 759332V90** Ø 80 cm, green
- 759333V90** Ø 80 cm, yellow
- 760113V90** Ø 80 cm, red



### Slip-on Cone Numbers

Turn your own cones into numbered cones with the slip-on number sleeves. Excellent teaching and organisational tool. Set of 10 in 5 different colours.

Fits cones of 23 cm. Material: 100% nylon

**33539V90**

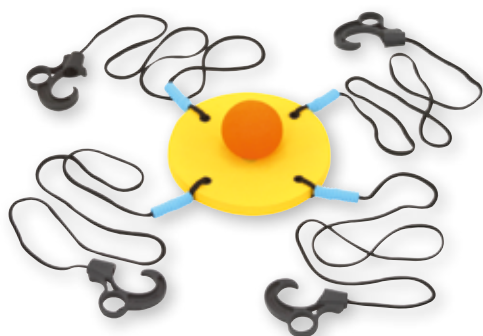

### Move & Balance Set

Transport the ball from one post to another without falling. Players must work together and keep the rope stretched while moving.

**Content:** 1 foam ball (Ø 60 mm) and 1 foam disc (Ø 17 cm) connected to 4 ropes with plastic handles.

Warning Notices: 1, 4 (page 271)

**34130V90**



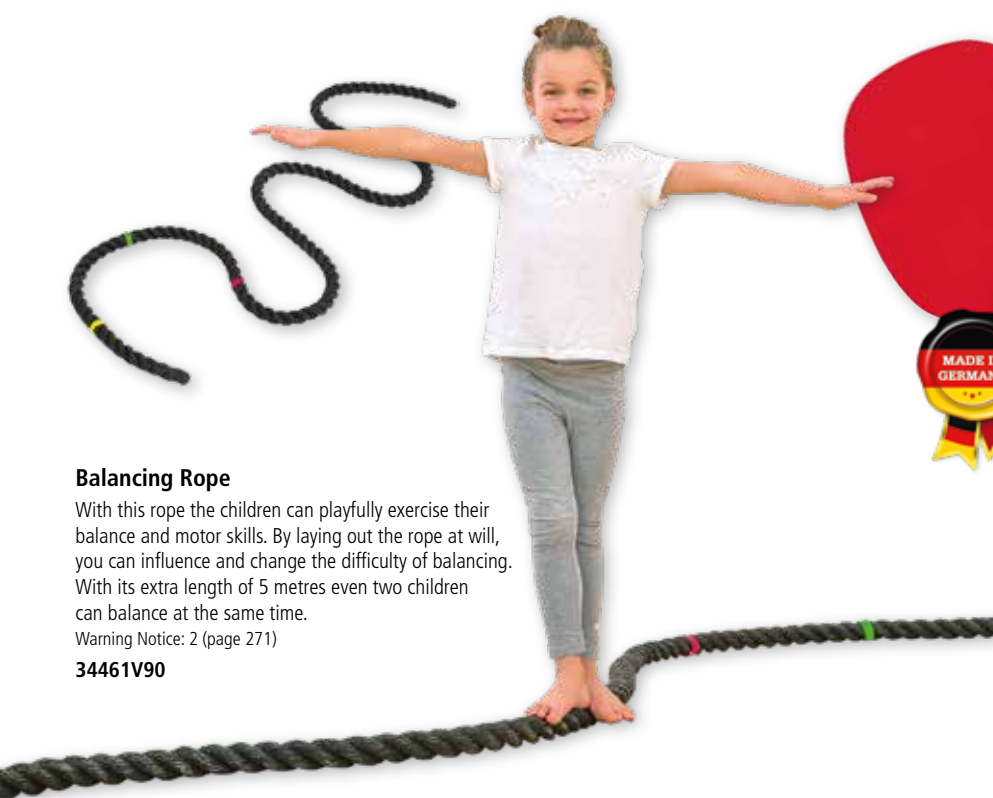

### Balancing Rope

With this rope the children can playfully exercise their balance and motor skills. By laying out the rope at will, you can influence and change the difficulty of balancing. With its extra length of 5 metres even two children can balance at the same time.

Warning Notice: 2 (page 271)

**34461V90**



### Snow Slider

The new snow slider creates lots of fun and movement in the snow. Thanks to the extra-wide sitting surface there is enough space for children in snowsuits. Size and stability guarantee safe sliding and even bumps and stones are no problem. The large handle provides a safe grip. Also suitable for adults.

All Warning Notice: 51 (page 271)

**850147V90** Red

**850148V90** Blue

**850149V90** Green



### Slackline Set

Thanks to the fixable guy rope children have very quick learning successes. This way balancing becomes easy. Good for coordination, endurance and sense of balance.

The kit consists of 1 line (15 m length, 5 cm width), 1 guy rope (15 m long, 2.5 cm width), 2 ratchets (made of stainless steel) with ratchet coverage, 2 tree protectors, 1 carrying bag (100% polyester)

Warning Notice: 2 (page 271)

**34144V90**



## Play and Fun Bin

Red bin on wheels with lots of different items for playing and sports indoors and outdoors. For different kinds of sports, such as darts, tennis, gymnastics and many more. Includes the following components: 1x storage bin red 120 l

10x skipping rope (3 m) in different colours

1x rope 5 m

6x barrel dollies (red, blue, yellow, pink, green, orange)

3x horse harness

1x soft throwing game

3x tail ball

6x ball catcher in different colours

2x super flying torpedo

1x mini tennis with 2 rackets and a soft ball

2x soft throwing discs

1x bouncy bag blue

1x bouncing bag red

3x schoolyard football yellow

1x bucket with 40 street crayons

1x balance board

1x Velcro® dart

Warning Notices: 1, 2, 3, 4, 52 (page 271)

756541V90

# FUN AND GAMES



## Movement in a Box

Set with 43 pieces to develop several skills. For kids over 3 years. For indoors and outdoors. Set includes the following components:

6 mini softballs

8 hole cones (2x red, 2x yellow, 1x orange, 1x pink,

1x blue, 1x green)

6 activity rings

6 pairs of barrel dollies (red, yellow, orange, pink, blue, green)

4x gymnastic poles

6x rubber balls

1x storage box

Warning Notices: 1, 3, 4, 16 (page 271)

755759V90





### Complete Motor Skills Set

With this set you get a complete activity field. This makes it easy to set up the best practice courses for skill, relay games, circus terrain or rally tracks. Ideal for outdoors and indoors!

Includes:

- › extensive set for various application possibilities
- › handy carrying bag
- › suitable for outdoors and indoors

Applications:

- › The cones are often used as a goal or for slalom run
- › When the sticks are placed between the cones, the little ones can either jump over it or crawl underneath
- › The hoops can be attached directly to the cones or with the connection clips. This creates great opportunities for climbing
- › All in all a great movement course if placed in a row

### Content:

- cones
  - bricks
  - 8 poles in 4 colours
  - 4 small hoops
  - 4 medium hoops
  - 30 clips
- Warning Notice: 2 (page 271)

**50691V90**





### Large Scooter Board

Made of strong, break-proof plastic. Perfect for rolling twosome. Provided with high quality ball-bearings.

Dimensions: 40 x 40 cm

Warning Notice: 23 (page 271)

**33690V90**



### Scooter Board with Handles

Great for working with children of all ages and abilities.

Made of heavy moulded plastic, with handles and rubber castors. Dimension: 30 x 30 cm

Warning Notice: 23 (page 271)

**33689V90**



### Scooter Board with Handles

Fun for kids of all ages with this sturdy plastic scooter for active play and exercise. Made of heavy moulded plastic with handles and plastic castors.

Dimensions: 30 x 30 cm

All Warning Notice: 23 (page 271)

**34410V90** Red

**54605V90** Green

**54604V90** Purple

**54606V90** Orange

**54607V90** Blue

**3855V90** Yellow

### Maxi Roller

A wonderful balancing and mobility tool, great for day-cares, physical therapy centres and schools. The kids may pedal the roller to move forward or backward. The shafts are made of strong steel and the pedals are covered with strong rubber.

Dimensions (W x D): 41 x 35 cm, wheel diameter: 15.5 cm

Warning Notices: 3, 15, 17, 22 (page 271)

**3110V90**



### Rock 'n' Hopper

Ideal to develop motor skill activities: balancing, jumping ... In the middle of the figure eight-shaped ball, there is a very stable plastic platform. Can be used by 1 child or 2 children. Dimension of the plate: 40 cm

Warning Notice: 3 (page 271)

**33340V90**

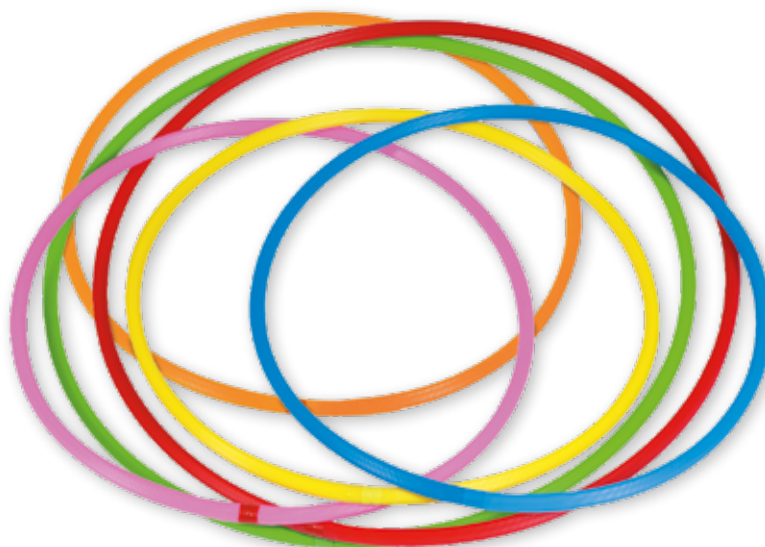

### Set of 6 Rainbow-Gymnastic tires

The set consists of 6 colourful, classical hula hoops in shiny rainbow colours.

Available in 2 sizes:

**757346V90** Ø 60 cm

**757350V90** Ø 80 cm

Minimum order: € 400,-



**Bricks**

These bricks can be used in conjunction with hoops and poles. Supplied in 6 colours and a set of 6 in 6 different colours

Dimensions (H x W x D): 9.5 x 36 x 15 cm

- 850121V90 Red
- 850122V90 Blue
- 850123V90 Yellow
- 850124V90 Orange
- 850125V90 Pink
- 850126V90 Green
- 756337V90 Set of 6

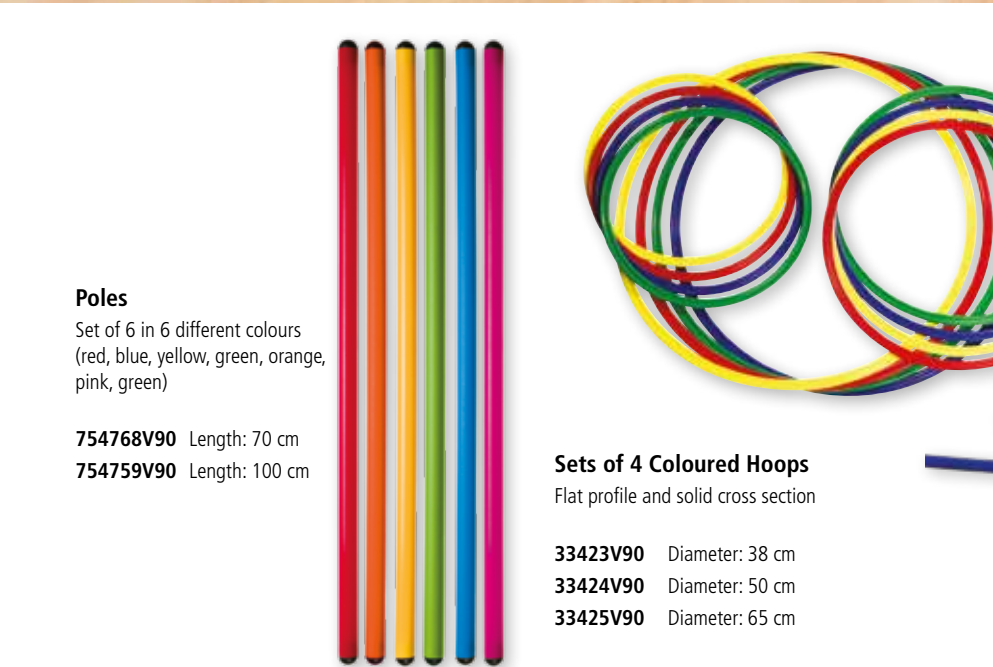

**Poles**

Set of 6 in 6 different colours (red, blue, yellow, green, orange, pink, green)

- 754768V90 Length: 70 cm
- 754759V90 Length: 100 cm

**Sets of 4 Coloured Hoops**

Flat profile and solid cross section

- 33423V90 Diameter: 38 cm
- 33424V90 Diameter: 50 cm
- 33425V90 Diameter: 65 cm

**Clips**

To be used in conjunction of the poles.

- 33429V90 Set of 30 clips

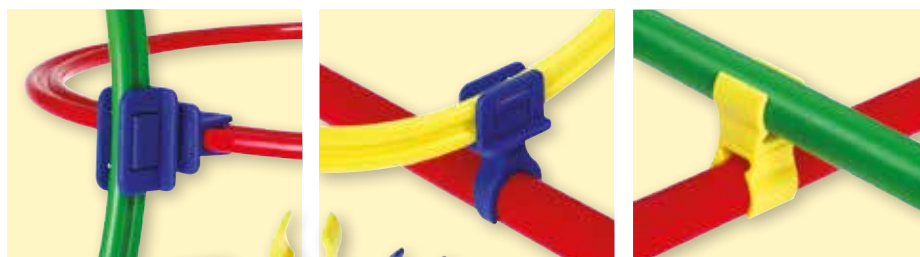

**Walking Board**

The very sturdy balancing board is fixed securely with only 2 plugs on the bricks. Maximum capacity: 80 kg

- Dimensions (H x W x D): 3 x 81 x 15 cm
- 50984V90
- Warning Notice: 3 (page 271)
- 50985V90 Connector





### Cone with Holes

Very sturdy plastic. Height: 30 cm  
Can be used in conjunction with the hoops and the poles.

- 850101V90 Green
- 850100V90 Blue
- 850099V90 Pink
- 850098V90 Orange
- 33426V90 Red
- 33427V90 Yellow
- 850129V90 Black
- 850130V90 White



### Cone Set "Rainbow"

Set of 6 cones in rainbow colours  
Height: 30 cm

754493V90 Set of 6



### Soft Foam Cones

Soft, moulded foam cones. Height: 18 cm  
Set of 6: 1 each of blue, green, orange, purple, red and yellow

Warning Notice: 1 (page 271)

755690V90 Set of 6



### Complete Motor Skills Set

#### Content:

30 clips, 3 red cones, 3 yellow cones, 4 bricks in yellow and red, 8 poles, 4 small hoops and 4 medium hoops

Warning Notice: 2 (page 271)

50691V90

#### Poles

Length: 70 cm  
Set of 4 poles in 4 colours

50690V90 Set of 4



#### Poles, Set of 6

754768V90 70 cm

754759V90 100 cm



Minimum order: € 400,-



### Balancing-Hedgehog

The balancing-hedgehog is made of high-quality, hard-wearing PVC, which is easy to clean. The hedgehogs have a hemispherical shape and are equipped with nubs on the surface. The set includes 6 pairs of balancing-hedgehogs in 6 different prismatic colours. The hedgehogs combine an effective balance-training with a comfortable effect of massage. Due to a needle valve it is possible to vary the air pressure and raise the challenge of balancing.

Diameter: 16 cm  
Material: polyvinyl chloride  
**757753V90** Set of 6



### Spike Balls

To stimulate observation and perception or simply to play. Big fun and a lot of possibilities. Comes in assorted colours.

- 3093V90** Size 1, ca. 6 cm, Ø, ca. 20 g
- 3161V90** Size 2, ca. 7 cm, Ø, ca. 50 g
- 3107V90** Size 3, ca. 8 cm, Ø, ca. 85 g
- 3108V90** Size 4, ca. 10 cm, Ø, ca. 165 g

# BALLS FOR ALL SENSES



**NEW**



### Set of 6 Sensomotoric Balls

All Warning Notice: 1 (page 271)  
**759287V90** Diameter: 11 cm  
**759289V90** Diameter: 23 cm

### Tactile Hands and Feet

These nubby floor markings attract every child. They do not only lead the way but also invite to touch. Children can see, feel and experience their paths.

- 33892V90** Set with 2 tactile feet, 21 cm
- 33893V90** Set with 2 tactile hands, 16.5 cm

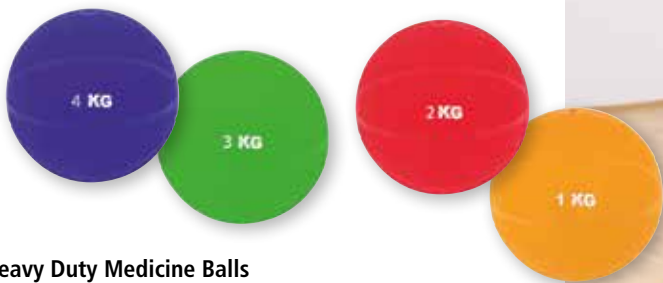

### Heavy Duty Medicine Balls

The ball is made of special material, which is very strong in quality. It is available in bright assorted colours. 100% polyvinyl chloride

- 34399V90** Yellow, 1 kg
- 34400V90** Red, 2 kg
- 34401V90** Green, 3 kg
- 34402V90** Blue, 4 kg



### Medicine Ball

Medicine balls made of extremely hard wearing synthetic leather, offer a high degree of strength and durability.

- 34156V90** Red, Ø ca. 50 cm, 1 kg
- 34158V90** Green, Ø ca. 60 cm, 2 kg
- 34159V90** Yellow, Ø ca. 70 cm, 3 kg



### Feet

Length: ca. 19 cm, set of 2

- 34415V90** Blue, 2 Pieces
- 34416V90** Red, 2 Pieces



### Hands

Length: ca. 16 cm, set of 2

- 34413V90** Blue, 2 Pieces
- 34414V90** Red, 2 Pieces

## FLOOR-MARKERS

ANTI-SLIP MARKS, IDEAL TO TRACE DIFFERENT PATHS ON THE FLOOR WITH THE DIFFERENT COLOURS.



### Arrow

Dimensions (W x H): ca. 34 x 16 cm

- 34423V90** Red
- 34424V90** Blue

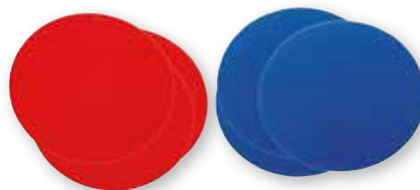

### Set of 6 Circles

3 pieces in blue and 3 pieces in red. Diameter: ca. 25 cm

- 33262V90** Set



### Line

Dimensions (W x H): ca. 34 x 7.5 cm

- 34421V90** Red
- 34422V90** Blue

Minimum order: € 400,-



### Team Colour Bibs

Excellent quality bibs – 100% polyester  
Available in 2 sizes – S for children up to 12 –  
L for older children

- 33441V90** Size S – Red
- 33442V90** Size S – Blue
- 33443V90** Size L – Red
- 33444V90** Size L – Blue



### Bicoloured Bibs

In just a few seconds two teams are clearly identified. The bibs made of 100% polyester are lightweight and breathable. If required they are machine-washable at 40 °C.

- 33548V90** Size 1 (up to 12 years)
- 33549V90** Size 2 (from 13 years)

## TEAM RIBBONS - EXTREMELY DURABLE!

IN DIFFERENT COLOURS. MADE OF POLYESTER. ENVIRONMENT-FRIENDLY. SMALL SIZE ESPECIALLY DESIGNED FOR THE YOUNGSTERS.



### Marker Cones

Very economical cones. Coloured marker cone made of durable plastic, available in 2 sizes:

**Dimensions (H x W x D): 23 x 13 x 13 cm**

- 3908V90** Yellow
- 3909V90** Orange

**Dimensions (H x W x D): 38 x 20 x 20 cm**

- 3918V90** Yellow
- 3919V90** Orange

### Team Ribbons, adjustable

Fits younger and elder children.  
Length: 41–59 cm, Material: 100% polyester

- 34383V90** Red
- 34384V90** Green
- 34385V90** Yellow
- 34388V90** Blue



### Seniorsize – normal, closed form, Set of 10

- 900446V90** Red
- 900447V90** Yellow
- 900448V90** Green
- 900449V90** Blue



### Juniorsize – open form with Velcro® fastening, Set of 10

- 900450V90** Red
- 900451V90** Yellow
- 900452V90** Green
- 900453V90** Blue

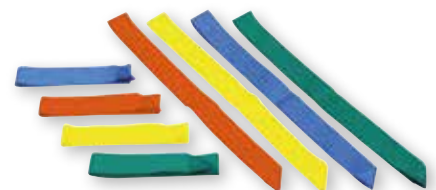

### Juniorsize – normal, closed form, Set of 10

- 900442V90** Red
- 900443V90** Yellow
- 900444V90** Green
- 900445V90** Blue





### Agility Hurdle – Collapsible

45 cm wide agility hurdles made of durable plastic.  
755685V90



### Markers

Set of 40 markers with stand. Made from soft plastic minimizing the possibility of injury when fallen on. Supplied as a set of 10x yellow, 10x red, 10x blue and 10x green on a stand.

3885V90



### Foldable Hurdles

This hurdle can be adjusted quick and easy to 3 heights between 6 cm and 38 cm. Use more than one to set up an obstacle course. Lightweight and portable.

33514V90

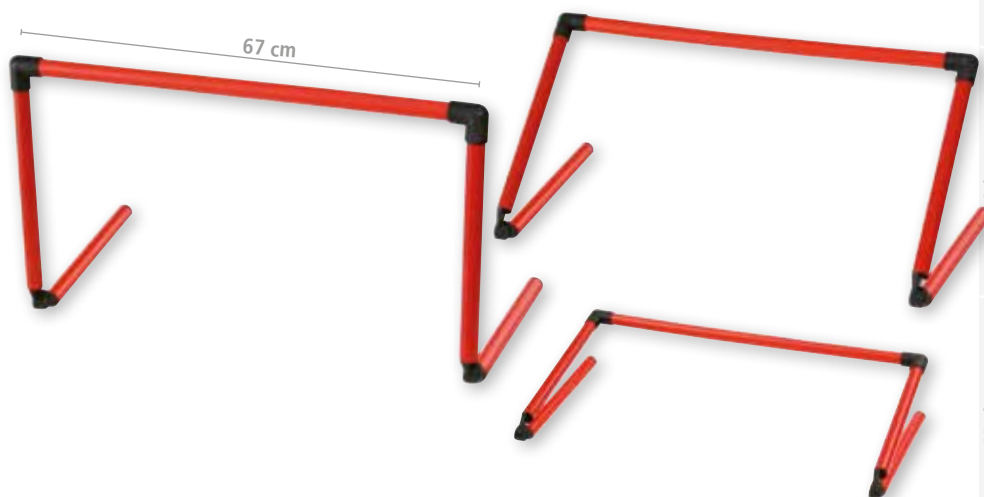

### Starter Clap

Provides loud and clear start signals! Starter claps are basic equipment in track and field athletics. Our model "Starti" is easy to handle and light weighted. Nevertheless the starting signal can be heard loud and clear on the field track. The optical signal can also be seen from far distances.

Dimensions (H x D): 51 x 7 cm, diameter: 30 cm, weight: 1080 g

33944V90

### Speed and Agility Ladder

Ultimate footwork training device. To improve foot quickness, agility, coordination and balance.

Length: 4 m, width: 51 cm  
Rungs spaced 41 cm

33509V90



Minimum order: € 400,-

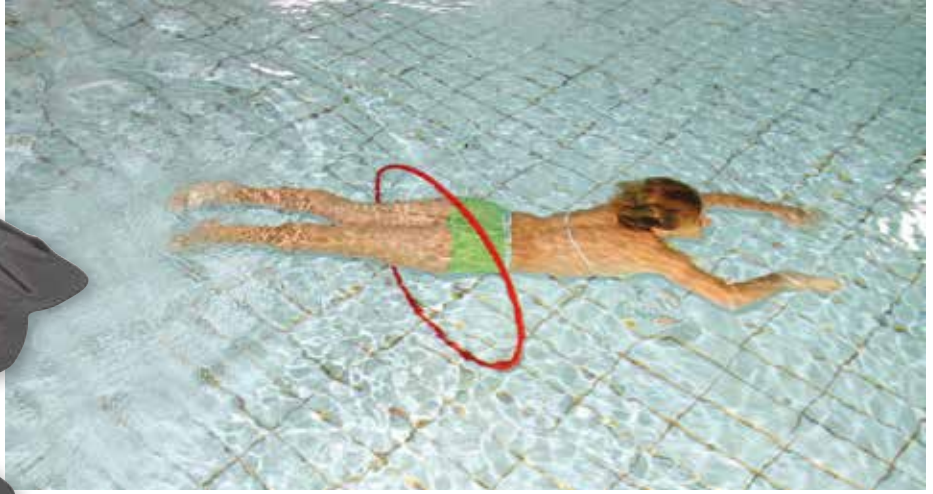

### Standing Hoop

Perfect for swimming and diving games. The heavy-weight hoop will sink to the bottom of the pool and land in a vertical position. Very sturdy, made of polyethylene. Diameter of ring: 76 cm, thickness: 20 mm

Warning Notice: 2 (page 271)

**36296V90**



### Play and Water Ball

Rubber ball with non-slip surface. Perfect for various games in the water.

Diameter: 22 cm, weight: 440 g

Warning Notice: 2 (page 271)

**33261V90**

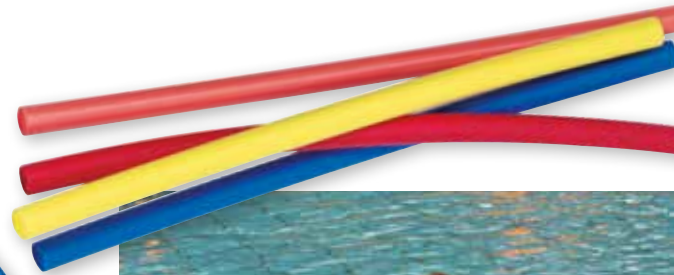

### Swim Noodles

Solid noodle for all pool activities. Great for teaching, water aerobics and fun too! Very durable and long lasting. Comes in assorted colours.

Length: 155 cm, diameter: 7 cm, weight: 200 g piece

Warning Notice: 31 (page 271)

**3838V90**

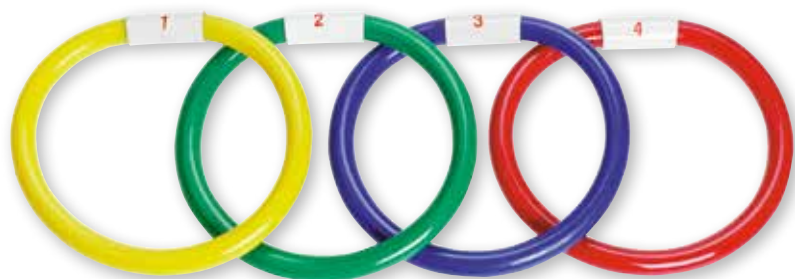

### Colourful Fins

Everyone can find the fitting fins in an instant now! Each size has its own colour. Students just have to grab the suitable fin and school lessons can start immediately. The large plastic blade allows maximum propulsion. The rubber foot entrance provides a high waring comfort and secure hold on wet pool surfaces.

**34295V90** Size 28–29, yellow

**34296V90** Size 30–31, pink

**34297V90** Size 32–33, purple

**34298V90** Size 34–35, red

**34299V90** Size 36–37, green

**34300V90** Size 38–39, blue

**34301V90** Size 40–41, aquamarine

**34302V90** Size 42–43, grey

**34303V90** Size 44–45, black

### Diving Rings

Weighted on one side to sink rapidly and to stand on the pool bottom.

Set of 4 rings with numbers.

Weight: 90 g

Warning Notice: 2 (page 271)

**33154V90**



### Electronic Whistle

The electronic whistle is hand operated by pushing the button. The two different tone-functions produce a constant and clear whistle sound. Compared to common whistles, the electronic whistle is very hygienic as it does not need to be put in the mouth and is therefore perfect for the daily school routine in which multiple people use the whistle. Keep the whistle ready at hand by wearing it around the neck using the practical lanyard.

**757696V90**

### Digital Stopwatch

Large digit display, alarm, 1/100 sec., date and time display. Sturdy and waterproof.

Dimensions (H x W x D): 7.1 x 6.2 x 1.9 cm

Weight: 50 g

**34411V90**

### Stopwatch "Athletic-Junior"

1/100 second, 5 digit display, lap function, time, calendar and alarm, water resistant.

Dimensions (H x W x D): 6 x 5 x 1.5 cm, weight: 30 g

**3697V90**



### Two-piece Harness

Made of soft nylon for up to 4 children. Movement-intensive play with the harness promotes communication and social skills.

**Content:** 1 harness for two „horses“

Dimensions: length of reins: 1 m, length connection =

distance 40 cm, chest circumference: 65 cm

Material: 100% nylon

Warning notice: 52 (page 271)

**759974V90**



Minimum order: € 400,-



**Seat Mat**

with two different surfaces  
 – one even and one napped side.  
 Dimensions (H x W x D): 32 x 38 x 1 cm

- 33857V90** Green
- 33858V90** Blue

**Storage Bag for Seat Mats**

For up to 30 mats.  
 Dimensions (H x W x D): 33 x 39 x 31 cm,  
 Material: 100% nylon  
**33908V90**

**Gym Exercise Mat**

Good price value. The mat is sturdy and easy to clean.  
 The mat has eyelets so it can also be hung up.  
 Dimensions (H x W x D): 1 x 140 x 50 cm  
 Material: 100% polyethylene  
**33903V90**



**Ball Bag with Wheels**

Practical bag that provides space for up to 15 balls  
 (size 5). With rubber wheels and padded handles.  
 Material: 100% polyester  
**36379V90**



**Compressor**

To inflate sports balls. No oil needed. Electric, 220 V.  
 Will inflate a ball in approx. 30 seconds.  
 With 3 adaptors.  
**3480V90**

**Folding Ball Carrier**

Very handsome trolley to store or transport 20 balls. Very  
 easy to be folded.  
 Dimensions (H x W x D): open – 88 x 64 x 64 cm  
 folded – 88 x 15 x 15 cm  
**33276V90**



### HUS Stones Game

#### The exciting game for young and old

HUS is a very popular strategy game in which the contents of dumps are redistributed according to certain rules. Promotes fine motor skills, logical-strategic thinking, arithmetic and counting. The game is made of solid rubberwood, has nicely rounded corners and molded hollows. The delivery includes 68 glass nuggets

Dimensions (H x W x D): 12 x 46 x 4 cm

Warning Notice: 1 (page 271)

**42449V90**



### Folding Chess Case

Chess game in folding portable wooden case.

Case turns into chess board when unfolded.

Includes: 32 wooden chess pieces.

Chess board area: 29.5 x 29.5 cm

Warning Notice: 1 (page 271)

**44489V90**



### Maxi Chess & Chequers

Affordable chess and chequers table.

The chess and chequers pieces can be stored in a drawer underneath the board.

Table size is 68 x 68 x 68 cm

King of chess is 18 cm tall.

Comes flat packed.

**44418V90**

Minimum order: € 400,-



### Tyrolean Roulette

Helps children from 7 years up to train their mental calculation skills. Material: rubberwood, outer diameter: 22 cm

Incl. 10 game balls

Warning Notice: 5 (page 271)

**44495V90**

# TEACHER RESOURCES

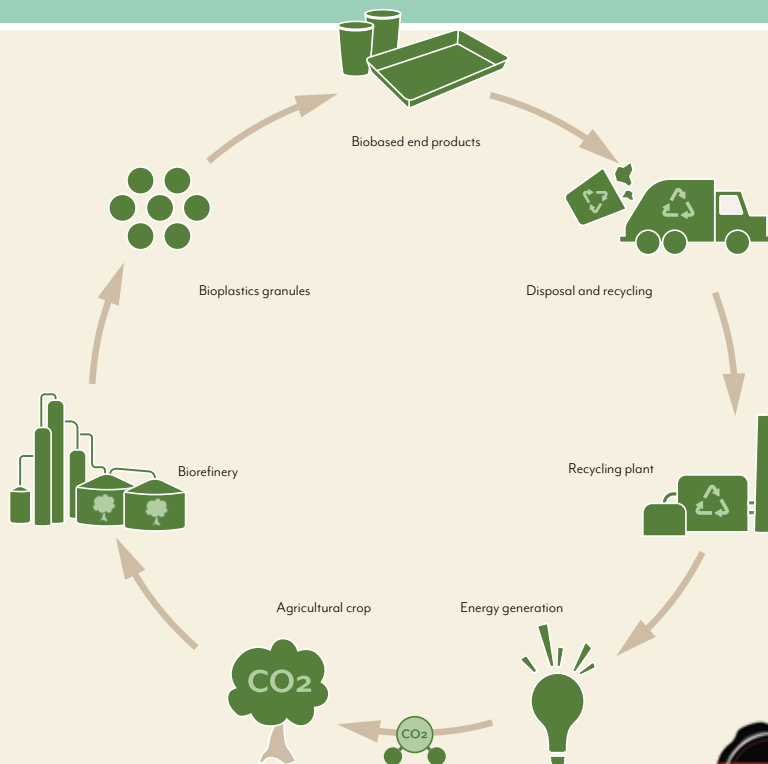

**treeNside – contains a lot of nature.**

Material trays made from selected wooden bio plastic granulate. This material is biobased and only uses minimal fossil resources.

**The most important details at a glance:**

- Produced in our own plastic manufacture
- Wooden bio plastic granulate – you can see and even smell it!
- Made from renewable raw materials, only using minimal fossil resources
- Short transport routes at procurement and production



**Pencil Holders, Set of 5, different colours**

Ideal for sorting and organising. Made from solide, sustainable treeNside material (bioplastics) that is made from fine wooden fibres. Set consists of 5 pencil holders in five colours (blue, green, yellow, orange, red).

Dimensions per pencil holder (H x W x D): 8 x 8.7 x 6.2 cm

**761918V90** Set of 5



**Storage Tower, 4 Large Drawers**

Use this tower as the perfect extension for cabinets and shelves or as a super flexible mobile organiser. The drawers are made from sustainable treeNside material (bioplastics). This material consists of fine wooden fibres. Drawers are stackable. The tower includes castors for mobility. It is up to you to create a freestanding tower, a cabinet storage or a roller container.

Dimensions (H x W x D): 86 x 30 x 38 cm

**850322V90 + colour**



**Sorting Trays, Small, Set of 5**

**Content:** 5 material trays each per colour

Dimensions (H x W x D): 2.6 x 18 x 12 cm

- 758887V90** Nature
- 758888V90** Yellow
- 758889V90** Orange
- 758890V90** Red
- 758891V90** Pink
- 758892V90** Purple
- 758893V90** Blue
- 758894V90** Green
- 850255V90** Set of 6 (nature, yellow, orange, red, blue, green)

**Please choose colour:**





### Mobile Book Box

The book storage is divided into 6 compartments and two low shelves for books and games. It is mounted on castors for easy movement. Made of plywood  
 Dimensions (H x W x D): 58.5 x 60 x 60 cm  
 Compartments: 15 x 16.8 x 27.5 cm  
 Shelves: 32.5 x 56.5 x 29 cm  
 Comes flat packed.

**85622V90**



### Jeans Sitting Ball

Comfortable sitting ball with jeans style cover. Ideal for children's yoga or for relaxed sitting. Helps to keep the balance. Styrofoam ball-filling. Outer cover made of 100% cotton (washable at 30 degrees), inner cover made of 100% polyester. With handle.  
 Weight: approx. 200 g  
 Diameter: 30 cm

**757871V90**



### Horizontal Book Rack

Ideal for classroom or library use. Easy wall fastening for storage and display books in an accessible height for children. Coated wire.  
 Dimensions (H x W x D): 44 x 89.5 x 9 cm

**755055V90** Silver

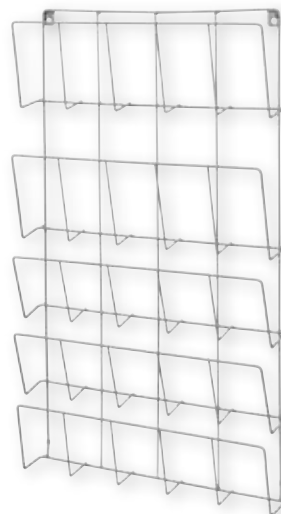

### Vertical Book Rack

Ideal for classroom or library use. Easy wall fastening for storage and display books in an accessible height for children. Coated wire.  
 Dimensions (H x W x D): 44 x 89.5 x 9 cm

**755056V90** Silver



Minimum order: € 400,-



### Drink Dispenser

This child friendly drink dispenser is the perfect tool for children to help themselves when they are thirsty. It is drip proof and has a swing-up carry handle for easy transport. Suitable for everyday use. Glasses not included.

Capacity: 27 l.

Dimension (H x W x D): 49 x 31.5 x 31.5 cm

Material: polypropylene

**56303V90**



### Felt Basket

Large felt basket, diameter: 38 cm, height: 18 cm, colour: grey, turquoise. Suitable for the storage of any small items, such as office material, toys, crafting material etc. Flexible felt (100% polyester), with handles.

**759151V90**



### Felt Bowls

Set of 7 felt bowls in 4 sizes. Suitable for the storage of any small items, such as office material, worksheets, crafting material etc. Flexible felt (100% polyester).

**760206V90**



### Felt Bowls

Set of 2 felt bowls, A4 size, colours: grey/turquoise and grey/green. Suitable for the storage of any small items, such as office material, worksheets, crafting material etc. Flexible felt (100% polyester).

**759152V90**



### Cotton Basket

A good idea for toys and baby's accessories.

Material: 100% cotton, machine washable at 40 °C

**56139V90** Small, Ø 35 cm, height: 27 cm

**56140V90** Large, Ø 57 cm, height: 42 cm





### Monster "Mimos"

Children can write or draw their problems or wishes on a piece of paper and feed the little monster.  
 Dimensions (W x H): 12 x 20 cm  
 Material: 100% polyester, washable up to 30 °C  
**97833V90**



### Gift Bag Santa

Great packaging for little presents.  
 Dimensions (W x H): 14 x 32 cm  
 Age: 18 M+  
 Material: 100% polyester, washable at 30 °C  
**755881V90**



### Gift Bag Rudi

Great for little Christmas gifts.  
 Dimensions (bag only (H x W x D)): 10 x 13 x 9 cm  
 Material: 100% polyester, washable at 40 °C  
**58089V90**



### Face Cloth Moose

Length: 29 cm, Material: 50% polyacrylic, 25% cotton, 25% polyester. Washable at 30 °C  
 Age: 18 M+  
**755688V90** Moose

### Face Cloth Angel

Length: 33 cm, Material: 50% polyacrylic, 25% cotton, 25% polyester. Washable at 30 °C  
 Age: 18 M+  
**57223V90** Angel



### Face Cloth Unicorn

Material: 100% polyester, washable at 30 °C  
 Age: 18 M+  
**760181V90** Unicorn

### Face Cloth Santa Claus

Material: 100% polyester, washable at 30 °C  
 Age: 18 M+  
**760179V90** Santa Claus

### Face Cloth Chick

Material: 100% polyester, washable at 30 °C  
 Age: 18 M+  
**760178V90** Chick



### Face Cloth Frog

Material: 100% polyester, washable at 30 °C  
 Age: 18 M+  
**760180V90** Frog

### Face Cloth Teddy

Material: 100% polyester, washable at 30 °C  
 Age: 18 M+  
**760182V90** Teddy



# BLANDAS

## CHILDREN'S MELAMINE TABLEWARE

Melamine tableware is perfect for everyday use. Melamine is a strong durable plastic. It resists scratching and staining, and is dishwasher safe. It is stackable for an easy storage. The dinnerware is available in 4 colours. Not suitable for microwave.

Please add the colour number

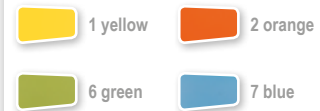

- > STACKABLE
- > FOR EVERYDAY USE
- > STRONG AND DURABLE
- > SCRATCH-RESISTANT
- > DISHWASHER-SAFE

1> Bowl, medium, Ø 14.5 cm  
56029V90 + colour number

2> Cup, 26.5 cl  
56027V90 + colour number

3> Tumbler, large, 27 cl  
56025V90 + colour number

4> Tumbler, small, 23 cl  
56024V90 + colour number

5> Bowl, small, Ø 11 cm  
56028V90 + colour number

6> Bowl, large, Ø 16 cm  
56031V90 + colour number

7> Plate, medium, Ø 20 cm  
56034V90 + colour number

8> Plate, large, Ø 25 cm  
56035V90 + colour number

9> Soup Plate, small, Ø 18.5 cm  
56032V90 + colour number

10> Soup plate, medium, Ø 21.5 cm  
56033V90 + colour number



### Children's Cutlery

Made of high-quality stainless steel 430. Every part is bigger than usual children's cutlery, anyway the parts are smaller than adult's cutlery. Easy cleaning in dishwasher. Rustproof and corrosion-free material. Perfect feel and impressive visual appearance due to mirror polish. Length: knife: 19.4 cm, fork: 18.7 cm, spoon: 18.7 cm, teaspoon: 13.9 cm

#### Content:

Set of 4 parts: 1 each: fork, knife, spoon, teaspoon  
Set of 144 parts: 36 each: fork, knife, spoon, teaspoon

**759302V90** Set with 144 pieces

**759304V90** Set with 4 pieces



### Cutlery

Made of chrome nickel steel with plastic handles. Length: 14 cm

**59156V90** Forks, 10 pieces

**59157V90** Knives, 10 pieces

**59158V90** Spoons, 10 pieces



### Cup

Diameter: 6 cm, height: ca. 10.5 cm, made of plastic  
**754635V90**



### Plate

Diameter: 22 cm, height: 2 cm, made of melamine  
**54070V90**

### Soup plate

Diameter: 16.5 cm, height: 3.5 cm, made of melamine  
**54071V90**

### Melamine Tableware

This colourful collection has earned its place at the children's table. The kid-friendly plates and bowls are made of shatter-proof melamine, the cups are made of plastic and the cutlery is made of chrome nickel steel with plastic handles.

#### Content:

10 plates, 10 soup plates, 10 cups, 10 forks, 10 spoons, 10 knives

Plate: Ø 22 cm, height 2 cm

Soup plate: Ø 16.5 cm, height: 3.5 cm

Cup: Ø 6 cm, height: ca. 10.5 cm

Cutlery: length: 14 cm

**55567V90** Set with 60 pieces





### Bibs with Dots

Easy to clean with a damp cloth due to the water repellent surface.

Dimensions (W x H): 30 x 40 cm

Material: 100% polyester, washable at 30 °C

Age: 12 M+

**56143V90** Blue

**56142V90** Green



### Serving Trolley

- > heavy duty; stainless steel
- > 4 casters, 2 with brakes
- > acid-proof and heat-resistant

Sturdy construction with 3 shelves each with a load capacity of 120 kg, 4 castors (2 with brakes). Delivered flat packed.

Dimensions (H x W x D): 94 x 86 x 54 cm

Material: stainless steel

**51856V90**



### Adult Apron

With hook-and-loop neck (67 cm) and waist straps (80 cm each).

Dimensions (W x H): 63 x 91 cm

Material: 100% polyester, washable at 30 °C

**56137V90**

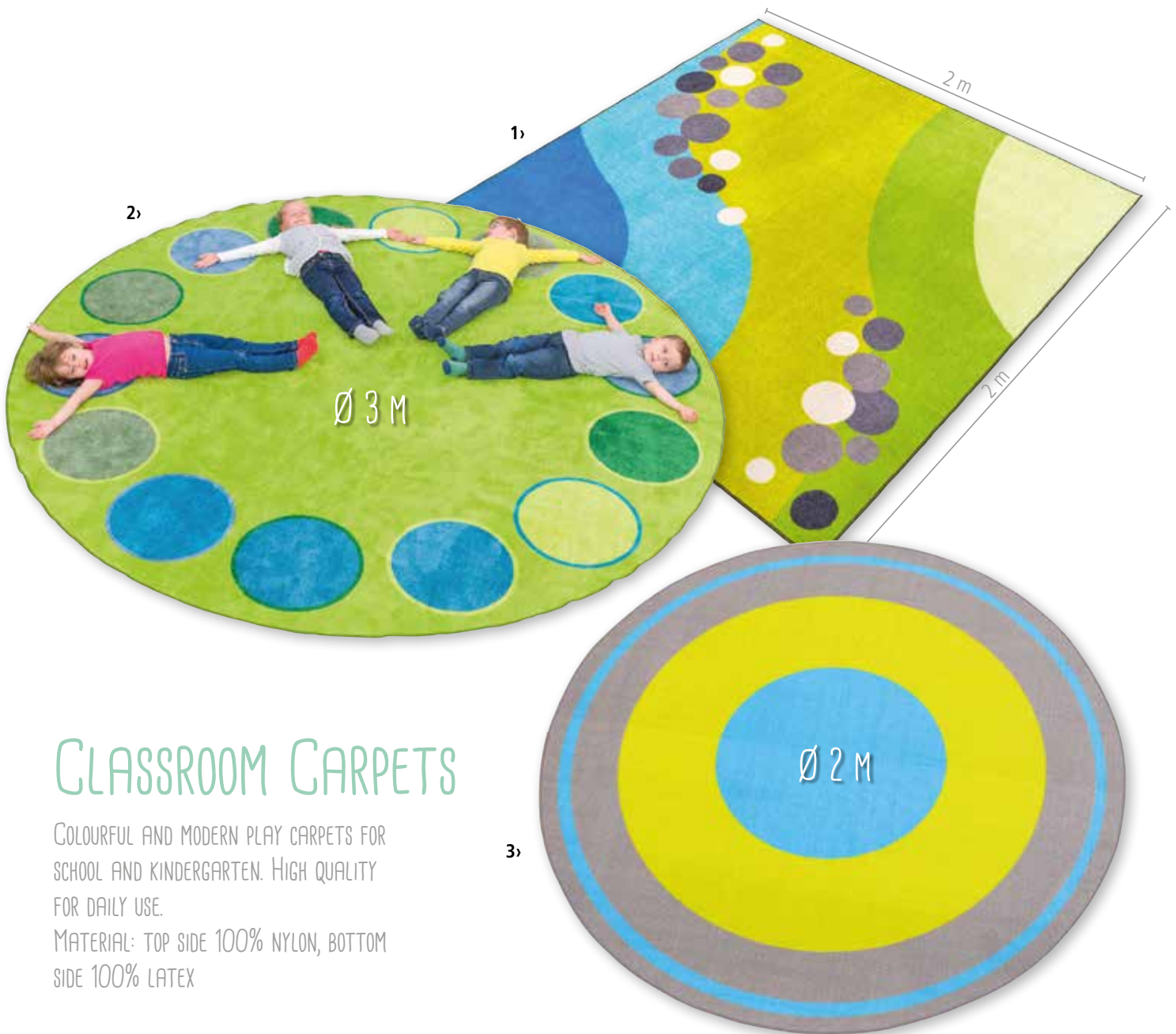

# CLASSROOM CARPETS

COLOURFUL AND MODERN PLAY CARPETS FOR SCHOOL AND KINDERGARTEN. HIGH QUALITY FOR DAILY USE.

MATERIAL: TOP SIDE 100% NYLON, BOTTOM SIDE 100% LATEX

## 1) Play Carpet "Landscape"

Dimensions: 200 x 200 cm

97702V90

Minimum order: € 400,-

## 2) Play Carpet "Dots"

Diameter: 300 cm

97705V90

## 3) Play Carpet "Pori"

Diameter: 200 cm

97701V90

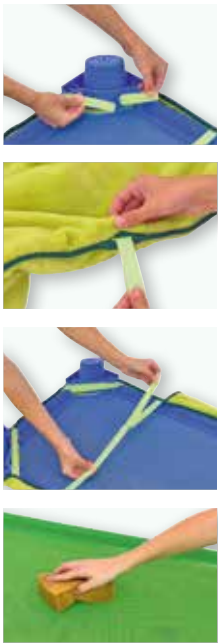

easy to clean



light weight



stackable



easy movement



### Indoor Sleeping Bag – For Stackable Beds

The sleeping bag is the perfect accessory for the stackable bed:

- › super-comfy material
- › secured with hook and loop fastener
- › these sheets allow beds to be stacked
- › summer and winter side
- › washable at 30 °C (Please strap all Velcro® bands together before washing)

Dimensions: 135 x 80/65 cm

Material: upper surface: 100% polyester, bottom surface: 100% cotton

**55868V90**

### Stackable Beds

Create relaxation rooms and bedrooms in an easy and speedy manner. Arrange or remove the beds according to your requirements.

- › very stable to prevent overturning
- › no sharp edges
- › fireproof material
- › air permeable
- › easy to clean, quick drying
- › high durability and capacity
- › extra light (3.8 kg)

Dimensions (W x H): 144 x 57 cm

**58902V90** Yellow

**59655V90** Green

**59653V90** Grey

**58903V90** Blue

**58904V90** Set of 4 castors



THE HOOKS POINT INSIDE.  
DISTANCE BETWEEN HOOKS  
IS 13 CM.

METAL: STURDY  
AND EASY TO  
CLEAN

4 CASTORS (LOCKABLE)



EXTRA WIDE SHELF  
TO STORE SHOES ON  
BOTH SIDES.

### Mobile Coat Rack

This double-sided mobile wardrobe is easy to move since it has 4 castors (lockable). It is at children's height so they can easily hang up their jackets all by themselves. The floor level storage shelf provides plenty of space for shoes, bags ...

Dimensions: 117 x 114 x 45 cm

**58837V90**

### Info Rail ME

Easy system to hang up pictures! Just take the picture or information sheet and insert it from below into the rail. For easy self mounting to the wall. The wall mounting can be either placed above each other or side by side. Mounting material included with each rail. 4 clips are also included with the 1 m rail and 8 clips with the 2 m rail for own markings.

- 12617V90 1 m
- 12618V90 2 m
- 12619V90 Info Rail ME – Rail Clips



### Display Rail in Aluminium

Transform the walls of the classroom in a display surface. Screw directly to the wall and the display rail is operational. Use in classroom or in the corridor for fixing writing boards, displays, poster, neat and tidy. The aluminium rail is approximately 2 cm wide and 5 cm high. Slide the paper/board in the clips and it is kept in place. Practical hooks to hold e. g. wall maps. Per metre 4 hook clips for maps are included.

#### 1) Aluminium Display Rail with Blue Blackboard

Insert magnetic, can be written on with chalk.  
79563V90 1 metre

#### 2) Aluminium Display Rail with Cork Insert

Push pins can be used on the cork surface, so clips are not needed. Ideal for displaying pictures.  
79559V90 1 metre

#### 3) Aluminium Display Rail with Cork Linoleum Insert

For use with push pins.  
79565V90 1 metre

#### 4) Aluminium Display Rail with Green Blackboard Insert

Steel board with green surface, can be written on with chalks.  
79561V90 1 metre

#### 5) Aluminium Display Rail with Whiteboard Insert

Insert magnetic whiteboard surface, can be written on with dry wipe board markers  
79567V90 1 metre



Minimum order: € 400,-



## WALL-MOUNTED COAT RACK

This heavy duty school coat rack can be easily self-assembled. No more coats on chairs; neaten up your classroom by providing a coat rack. The 8 mm hooks are pointing to the wall to avoid injuries. All steel parts are strongly welded. The rack includes screws and wall mountings. (1 m = 12 hooks, 1.5 m = 18 hooks)

- > SAFETY RACK WITH REVERSED HOOKS
- > OPTIMAL DISTANCE BETWEEN HOOKS 12 CM
- > ROUNDED STEEL HOOKS 8 MM
- > STRONGLY WELDED SEAMS VERY STABLE



### Coat Rack, yellow

70454V90 1 m

70458V90 1.5 m

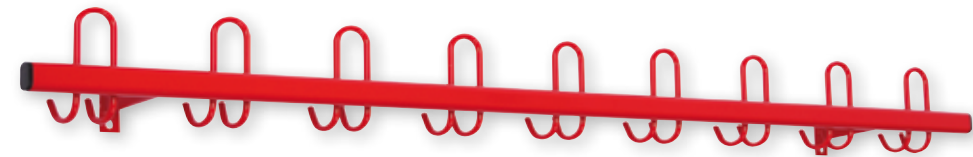

### Coat Rack, red

70455V90 1 m

70459V90 1.5 m

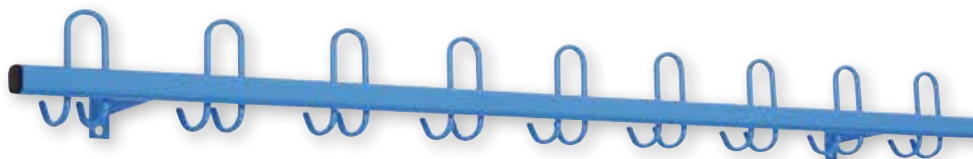

### Coat Rack, blue

70456V90 1 m

70460V90 1.5 m



### Coat Rack, aluminium white

70457V90 1 m

70461V90 1.5 m

### Connectors for Coat Racks and Shoe Storage Bench

To link contiguous elements.

73740V90 Yellow

73742V90 Blue

73741V90 Red

73743V90 Aluminium White





# STACKABLE SHOE STORAGE BENCH

No more wet and dirty shoes in classroom. Keep your classroom hygienic by leaving outdoor shoes in the shoe rack and only wearing house shoes in class. The top can be used as a bench.

Can be easily self-assembled.

## Floor Rack for Low Shoes

- 70462V90 Length: 1 m, yellow
- 70463V90 Length: 1 m, red
- 70464V90 Length: 1 m, blue
- 70465V90 Length: 1 m, aluminium white
  
- 70466V90 Length: 1.5 m, yellow
- 70467V90 Length: 1.5 m, red
- 70468V90 Length: 1.5 m, blue
- 70469V90 Length: 1.5 m, aluminium white

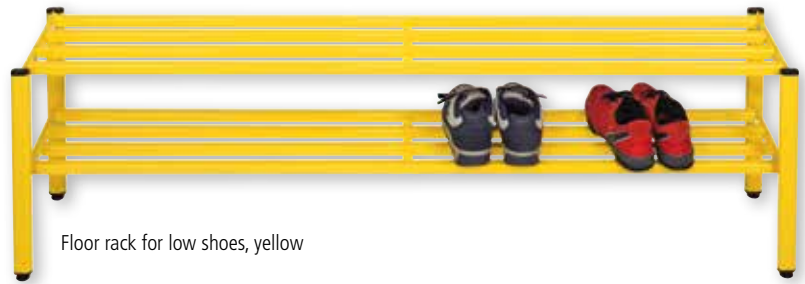

Floor rack for low shoes, yellow

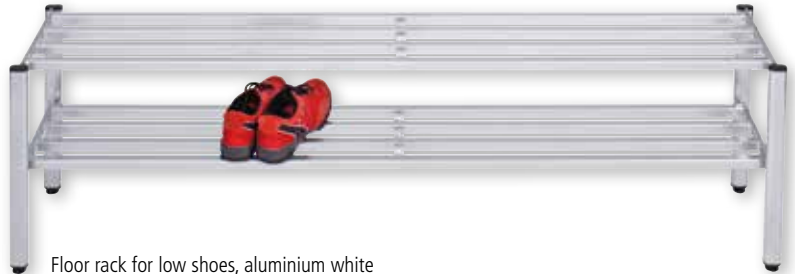

Floor rack for low shoes, aluminium white

## Floor Rack for Boots

- 70470V90 Length: 1 m, yellow
- 70471V90 Length: 1 m, red
- 70472V90 Length: 1 m, blue
- 70473V90 Length: 1 m, aluminium white
  
- 70474V90 Length: 1.5 m, yellow
- 70475V90 Length: 1.5 m, red
- 70476V90 Length: 1.5 m, blue
- 70477V90 Length: 1.5 m, aluminium white

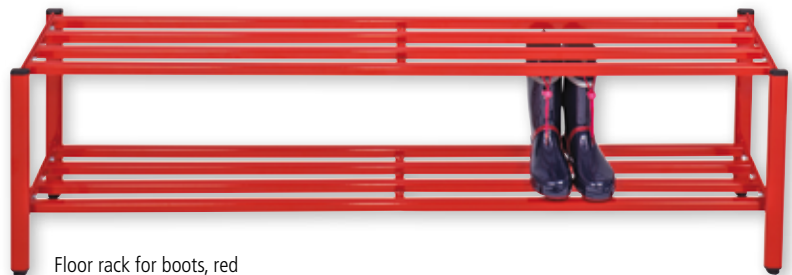

Floor rack for boots, red

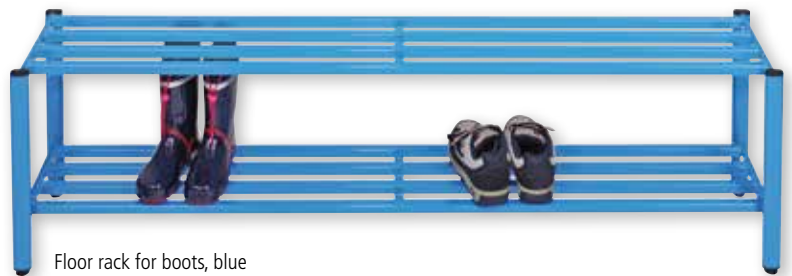

Floor rack for boots, blue

## Top Rack

Create extra storage space by stacking additional racks on top.

- 70478V90 Length: 1 m, yellow
- 70479V90 Length: 1 m, red
- 70480V90 Length: 1 m, blue
- 70481V90 Length: 1 m, aluminium white
  
- 70482V90 Length: 1.5 m, yellow
- 70483V90 Length: 1.5 m, red
- 70484V90 Length: 1.5 m, blue
- 70485V90 Length: 1.5 m, aluminium white

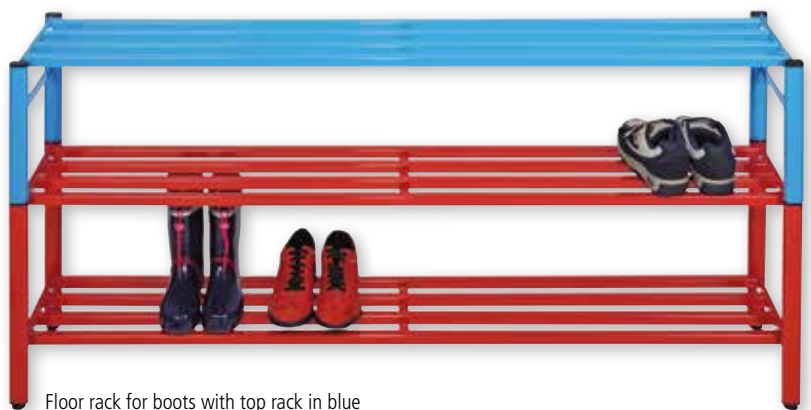

Floor rack for boots with top rack in blue

- > HEAVY DUTY: STRONGLY WELDED STEEL
- > UNLIMITED COMBINATIONS OF FLOOR RACKS AND ADDITIONAL RACKS
- > THE TOP RACKS COME WITH A WALL FIXATION KIT FOR EXTRA SAFETY

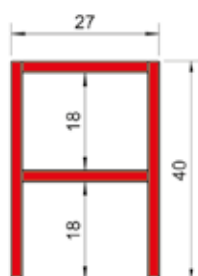

Floor rack for low shoes

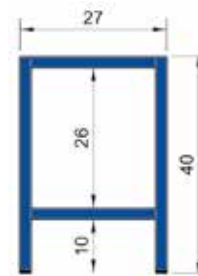

Floor rack for boots

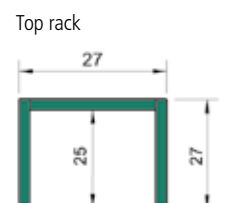

Top rack

# GET ORGANISED - USE THE MOBILE STORAGE TOWER

- > STURDY
- > SHOCK-RESISTANT
- > CAN BE RINSED OUT
- > EXTENDABLE



## Mobile Storage Tower

Use this tower as the perfect extension for cabinets and shelves or as the super flexible mobile organiser. The plastic storage drawers can be easily stacked together and combined in an array to suit your needs. They are extremely sturdy and shock-resistant. The tower includes castors for mobility. It is up to you to create a freestanding tower, a cabinet storage or a roller container.

### 1> Storage Tower with 4 Large Drawers

Dimensions (H x W x D): 86 x 30 x 38 cm  
850000V90 + colour

### 2> Storage Tower with 8 Small Drawers

Dimensions (H x W x D): 86 x 30 x 38 cm  
850001V90 + colour

### 3> Storage Tower with 6 Small Drawers

Dimensions (H x W x D): 66 x 30 x 38 cm  
850003V90 + colour

### 4> Storage Tower with 2 Small and 2 Large Drawers

Dimensions (H x W x D): 66 x 30 x 38 cm  
850004V90 + colour

### 5> Storage Tower with 3 Large Drawers

Dimensions (H x W x D): 66 x 30 x 38 cm  
850002V90 + colour

Please indicate the colour suffix of the drawers

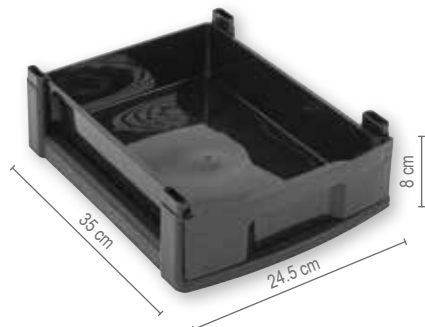
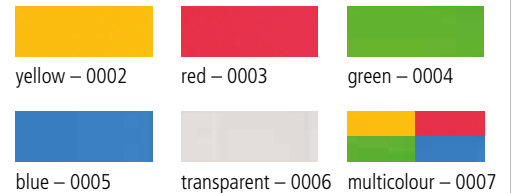

### Small Drawer

Including frame  
The frames are stackable. Inner dimensions of the drawer (H x W x D): 8 x 24.5 x 35 cm  
Please order lid separately.

#### Black frame, drawer colour:

- 850073V90 Red
- 850075V90 Blue
- 850074V90 Green
- 850072V90 Yellow
- 850076V90 Transparent
- 850113V90 Black
- 850115V90 Grey

#### Grey frame, drawer colour:

- 850083V90 Red
- 850085V90 Blue
- 850084V90 Green
- 850082V90 Yellow
- 850086V90 Transparent
- 850114V90 Black
- 850116V90 Grey

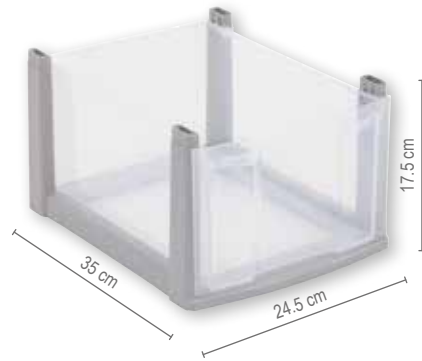

### Large Drawer

Including frame  
The frames are stackable. Inner dimensions of the drawer (H x W x D): 17.5 x 24.5 x 35 cm  
Please order lid separately.

#### Black frame, drawer colour:

- 850078V90 Red
- 850080V90 Blue
- 850079V90 Green
- 850077V90 Yellow
- 850081V90 Transparent
- 850117V90 Black
- 850119V90 Grey

#### Grey frame, drawer colour:

- 850088V90 Red
- 850090V90 Blue
- 850089V90 Green
- 850087V90 Yellow
- 850091V90 Transparent
- 850118V90 Black
- 850120V90 Grey

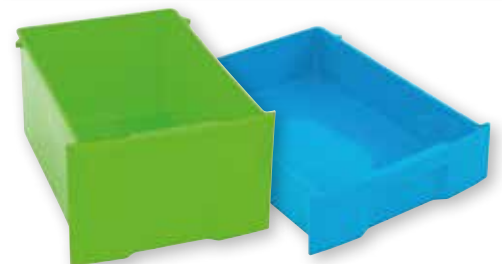

Lid and rollers can be ordered separately. The lid serves to complete a tower of drawers. Can be used with or without rollers: You can either place the tower at a fixed location or take it to wherever you need it.

### Lid for frame

- 850054V90 Black
- 850071V90 Grey

# EASY LOGISTICS!

>>> 16 UNITS PER PALLET!

Depending on what you need we will deliver the storage towers wrapped or in a mailorder carton.

The castors are inside one of the drawers.

MAILORDER PACKAGING AVAILABLE!



Easy-Clip-Connectors  
79291V90



## 1) Storage Tower with 18 Small Drawers

Dimensions (H x W x D): 66 x 90 x 38 cm

850016V90 + colour

## 2) Storage Tower with 9 Large Drawers

Dimensions (H x W x D): 66 x 90 x 38 cm

850015V90 + colour

## 3) Storage Tower with 24 Small Drawers

Dimensions (H x W x D): 86 x 120 x 38 cm

850008V90 + colour

## 4) Storage Tower with 12 Large Drawers

Dimensions (H x W x D): 86 x 120 x 38 cm

850007V90 + colour

## 5) Storage Tower with 24 Small Drawers

Dimensions (H x W x D): 86 x 30 x 38 cm

850010V90 + colour

## 6) Storage Tower with 12 Large Drawers

Dimensions (H x W x D): 86 x 30 x 38 cm

850013V90 + colour

## 7) Storage Tower with 32 Small Drawers

Dimensions (H x W x D): 86 x 30 x 38 cm

850011V90 + colour

## 8) Storage Tower with 16 Large Drawers

Dimensions (H x W x D): 86 x 30 x 38 cm

850014V90 + colour

By using the clip-connectors your customers can select whatever combination they like. Your extreme advantage of the Flexeo® System Towers:  
**Few SKU lead to endless combinations!**

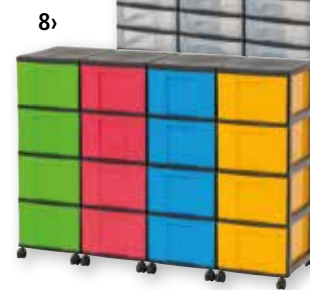

# DISPLAY BOARDS



2›

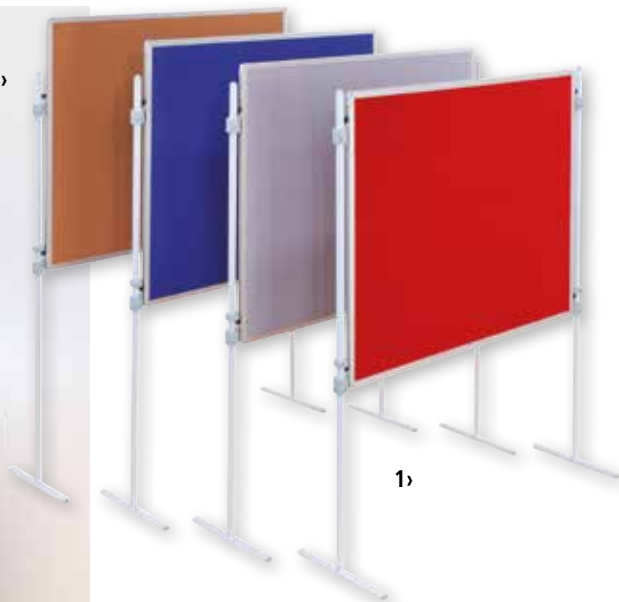

1›

## Display Boards

- › aluminium frame – double-sided panels
- › available in 3 colours – red, grey and blue
- › dimensions (W x H): 150 x 120 cm
- › can be used in 2 directions – landscape or portrait
- › ideal to display art work or to make presentations
- › enables classroom to be divided with ease
- › can be used with Velcro® or with pins
- › easy to assemble on the grey foot

### 1› Panels 150 x 120 cm

**76742V90** Red

**76743V90** Blue

**76744V90** Grey

**76745V90** Stand Grey

### 2› Comprá® Display Board – Cork

Dimensions (W x H): 150 x 120 cm, delivery without stand (see below)

**76741V90** Cork



3›



4›

### 3› T-Stand

1 pc, height: 1.94 m, grey

**76745V90**

### 4› Round Stand

1 pc, height: 1.94 m, grey, made from polyamid

**82621V90**



## DISPLAY BOARD AT CHILDREN'S HEIGHT

### Children's Board Display Panel

Display board at children's height  
 These panels can be set up individually and can be used at both sides. The light weight material and the easy click assembly make it very simple to install and dismantle the panels. The boards can be plugged-in in 2 directions – landscape or portrait. One landscape – one portrait, one red – one blue ...

Both sides have textile covered surfaces for fixating objects with Velcro® tape or attaching papers with pins.

Dimensions (W x H): 120 x 75 cm  
 Please order the stand separately.

### Display Board, 1 pc.

- 76923V90 Blue
- 76922V90 Red
- 76924V90 Grey

### Stand at children's height

To be used with the display boards  
 Solid tubular frame, light grey, with T-foot, height: 150 cm, 1 pc.

76925V90



## GREENBOARDS

- › Especially developed for schools.
- › The surface is very similar to conventional schoolboards.
- › Robust aluminium frame with consolidated angles.
- › Very comfortable to write on.
- › Cleaning as usual: wet or dry.
- › Magnetic because of the steel back sheet.
- › With clipboard for chalk.

Wall fastening material included

**74957V90** 90 x 60 cm

**74958V90** 120 x 90 cm

## WHITEBOARDS

- › Robust aluminium frame with consolidated angles.
- › Magnetic because of the steel back sheet.
- › Scratch-resistant surface made of coated steel.
- › Easily dry cleaning.
- › Writable with whiteboard markers.
- › With clipboard.

Wall fastening material included

**74951V90** 90 x 60 cm

**74952V90** 120 x 90 cm

## PINBOARDS

### Fabric Covered Pinboard with Aluminium Frame

Use push pins for prompt sharing of information and announcements on this softboard. No lasting pin holes thanks to the robust velour, not even in case of frequent use. Aluminium frame with rounded plastic corners. The pinboard can be used horizontally and vertically. Includes installation set for wall mounting. Thickness: 1.6 cm

**73862V90** Blue: 90 x 60 cm

**73863V90** Blue: 120 x 90 cm

**73864V90** Blue: 150 x 100 cm

## CORKBOARDS

### With Aluminium Frame

Use push pins for prompt sharing of information and announcements on this corkboard. No lasting pin holes thanks to the self-healing cork material, not even in case of frequent use. Aluminium frame with rounded plastic corners. The pinboard can be used horizontally and vertically. Includes installation set for wall mounting. Thickness: 1.6 cm

**73859V90** 90 x 60 cm

**73860V90** 120 x 90 cm

**73861V90** 150 x 100 cm



### Portable Magnetic Screen

The most simple and easy way of installing a projection screen. In between classes there is not much time to set up the classroom for the use of multimedia. Often there is no time left to get and assemble a portable projection screen. The solution is to unroll the magnetic screen and apply it on the blackboard surface. Instantly you can start projecting with the beamer or the overhead projector. The material of the magnetic screen surface resembles the usual whiteboards. It is matt white and reflects the light optimally without blinding. This generates bright and intensive colours. The extraordinary strong material facilitates an installation of the screen in no time and without any wrinkles. Dimensions (W x H): 90 x 125 cm

**73458V90**

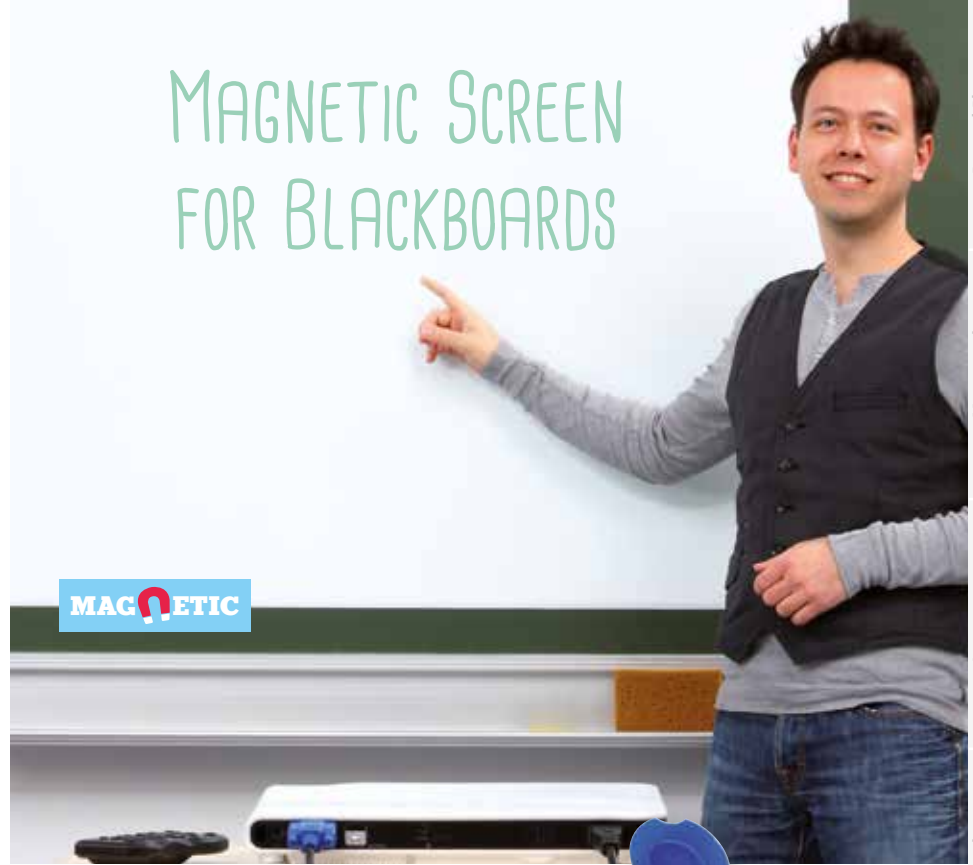

### Whiteboard Marker

The Whiteboard Marker is available in a set with 4 colours: red, blue, black, green.  
 › round tip, diameter: 1.5 cm  
 › dry wipeable  
 › suitable for all whiteboards and flipcharts

**754794V90**



### Whiteboard Wiper

The form of the wiper guarantees an excellent wiping result. The wiper lies good in the hand and slides across your whiteboard without difficulty due to the exchangeable cleaning felt.  
 Dimensions (H x W x D): 3.8 x 14.5 x 4.3 cm  
 Cleaning surface: 4.3 x 14.5 cm

**756414V90**



### Whiteboard Cleaning Wipes, 100 pieces

The wet wipes clean your whiteboard spotlessly clean and tidy. The practical dispenser enables to take out one cleaning tissue at a time. The dispenser offers 100 cleaning wipes.

**756269V90**



### 6 Little Whiteboards

Children like interactive learning by writing or drawing on their own individual little whiteboard, and then holding it up to show the teacher and the rest of the class. The whiteboards can be written on with standard dry wipe whiteboard markers, and then easily wiped clean for re-use over and over again.

**756964V90** Set of 6, 12.5 x 14 cm

**759012V90** Set of 3, A4

**759013V90** Set of 3, A3



# SPACE SAVING



## Desk Privacy Panel

Quickly arrange the privacy panels on the desk to avoid cheating during exams or tests. Due to the roundness in the front the teachers have a free view on the exercise sheets of their students. The back end of the panel is very thin. This prevents students from slipping cheat sheets underneath the panel, as they can easily be spotted by the teacher.

The privacy panels can be removed quickly and they require very little storage space in the classroom. The table positioner blinds are available in 3 variations: white or with motifs "ABC" or "123". Once set on the desk, they have a size of 37 x 52 x 9 cm (H x W x D).

**756743V90** Desk privacy panel "language"

**755878V90** Desk privacy panel "math"

**755872V90** Desk privacy panel "white"



SET-UP 1



SET-UP 2



SET-UP 3

## Multipurpose Utility Cart

Made of shock-resistant plastic. Guaranteed mobility! Everything stays in place due to roughened and non-skid trays with slightly raised edges. Equipment is moved from one classroom to the other quick and safely. Dual lockable castor wheels provide a firm stand. The stack system allows various modes of set-ups. In a few simple steps, the cart can be enlarged or reduced. Tools are not required for assembly.

Scratch-resistant and shockproof trays keep this cart looking like new. Tripping hazards can be avoided by simply using the lateral fixture clips for cables.

Loadable up to 80 kg. With silent castor wheels. Dimensions (H x W x D):  
 Large: 108 x 69 x 46 cm  
 Medium: 87 x 69 x 46 cm  
 Small: 61.5 x 69 x 46 cm

**77674V90** Black





### Magnetic Traffic Light – Behaviour Management

Implement classroom rules and illustrate misbehaviour with the traffic light system. The traffic light is magnetic and can be mounted to any magnetic surface (can also be fixed to walls).

- › 1x magnetic traffic light – behaviour management (26 x 40,5 cm)
- › 40x magnetic dry-erase name tags (6 x 2 cm)
- › 2x magnetic covers (Ø 13 cm)

74593V90



### Presentation Cards

Special whiteboard coating allows for use with board marker pens and dry wiping. The cards stick to all magnetic surfaces, for example white or green boards.

#### Content:

6x rectangle (20 x 10 cm), 6x circle (Ø 14 cm), 6x oval (20 x 11 cm), 4x cloud (28.3 x 17.6 cm)

754655V90 22 pcs.

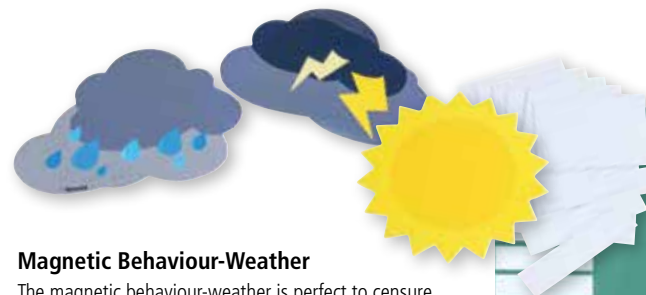

### Magnetic Behaviour-Weather

The magnetic behaviour-weather is perfect to censure students during the lesson. Connected with the magnetic name badges it is possible to illustrate the current status on the scale of admonition. It is possible to write on the badges with whiteboard-markers and to wipe it off again.

Dimensions of the magnets (W x H):

sun: ca. 20 x 20 cm, rain cloud: ca. 27.5 x 20 cm, thundercloud: ca. 27 x 20.5 cm, name badge: 14.7 x 3.5 cm

#### Content:

- › 3 big magnetic weather-symbols (sun, rain cloud, thundercloud)
- › 36 magnetic name badges

757111V90





### Smiley Magnet Set

These happy smiley magnets create a cheerful atmosphere in class.

Use them to hold up papers or pictures or simply to inspire. There are plenty of options.

They can hold up to 4 sheets of paper, diameter: 3 cm.

**79513V90** Set of 6



### Magnetic Clips

Simply place the clip on metallic surfaces like a board to hang up posters, pictures and presentations.

**900376V90** Set of 6



### Strong Magnetic Clip

Use big metal clips to present posters or conference papers in just a second! They stick to the board or to any other magnetic surface and have a protective foil on the bottom of the magnet to prevent marks and scratches.

Dimension: 9.5 cm, clamp opening: 2.5 cm.

**73869V90** Set of 2

### Magnetic Tape

Flexible magnetic tape is perfect for making objects magnetic. Self adhesive. Can be cut with scissors.

0.7 mm thick for paper, cardboard etc.

**98V90** 2 cm wide, 1 m

**99V90** 2.5 cm wide, 1 m

1.7 mm thick for heavier objects.

**100V90** 2 cm wide, 1 m

**101V90** 2.5 cm wide, 1 m

Magnetic Tape, 10 metres  
Flexible magnetic tape in different sizes.

0.7 mm thick

**24V90** 2 cm wide

**25V90** 2.5 cm wide

1.7 mm thick

**26V90** 2 cm wide

**27V90** 2.5 cm wide



### Magnetic Squares Tape – in a Practical Dispenser

Magnetic on one side only, reverse side is self-adhesive, can be used to furnish paper, photographs, cards etc. with magnetic backing. Instructions are included on how to turn the packaging into a dispenser.

**79785V90**



### Magnetical Adhesive Tape with Handy Dispenser

Whether paper or other materials, just stick the tape on and make them magnetic.

This practical aid should not be missed on your desk. 8 metre, 1.9 cm wide, 0.3 mm thick

**78566V90**

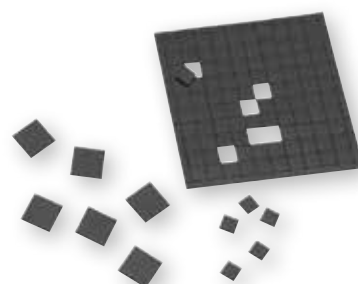

### Magnet Stickers

Self-adhesive magnet-squares

**7788V90** 1 x 1 cm

**86605V90** 2 x 2 cm

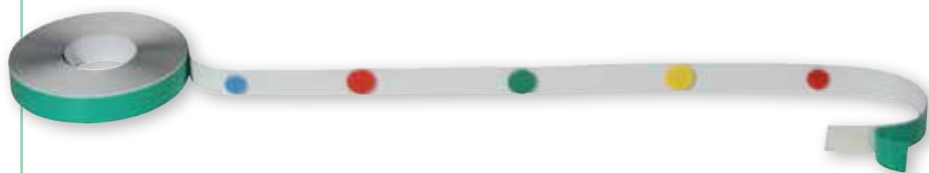

### Self-adhesive Steel Tape

Attach steel tape to the surface. The strip is now ready to accept magnetic items such as magnetic tape and memo magnets etc.

**74229V90** 5 m

**73950V90** 25 m



**Chair Bag**

The practical school chair bag fits all common chair backs. The large pocket can be filled with books, atlases or even material for art lessons. Thanks to the practical carrying handle, transporting from one classroom to the next is no problem. All seams are processed safely and stably. Dimensions (W x H): 40 x 35 cm  
Material: 100% polyester  
**755818V90**



**Magnet Set**

The thin magnetic discs are 1 mm thick and have a diameter of 3.5 cm. They adhere to magnetic surfaces without any problems. The set consists of 42 magnetic discs in 33 different motives. Scope of delivery: 42 magnet discs in 33 different motives  
**760296V90**



**Colourful Magnetic Discs**

The thin magnetic discs are 1 mm thick and have a diameter of 3.5 cm. They adhere to magnetic surfaces without any problems. The set consists of 42 magnetic discs in 7 different bright colours: yellow, orange, red, purple, pink, blue and green. They are perfect for lessons, e.g. as numeration dots, markers of groups or for computing operations. Scope of delivery: 42 magnet discs in 7 colours, 1 plastic storage-box  
**757518V90**



**Sorting Trays**

**Set of 6 Small Sorting Trays in 6 Colours**  
**850111V90** 2.6 x 18 x 12 cm  
**Set of 6 Large Sorting Trays in 6 Colours**  
**850112V90** 4.7 x 23 x 14.7 cm



### Magnets

Dimensions: diameter: 2 cm, height: 0.6 cm

- 757086V90** White
- 757083V90** Red
- 757081V90** Blue
- 757084V90** Orange
- 757082V90** Green
- 757085V90** Black
- 757080V90** Pink
- 757079V90** Yellow
- 757437V90** Set of 80 magnets, diameter 2 cm

### Magnets

Dimensions: diameter 3 cm, height: 0.6 cm

- 757097V90** White
- 757094V90** Red
- 757092V90** Blue
- 757095V90** Orange
- 757093V90** Green
- 757096V90** Black
- 757091V90** Pink
- 757090V90** Yellow
- 757438V90** Set of 80 magnets, diameter 3 cm



### Overhead Marker with Blotting Felt and Magnet – black

Can be used on nearly all writable surfaces and is easily wiped off. The integrated magnet allows for easy attaching to any magnetic surface such as a white- or blackboard. The marker is also usable for overhead transparencies or laminated working sheets which can be reused due to the blotting felt.

**758073V90**

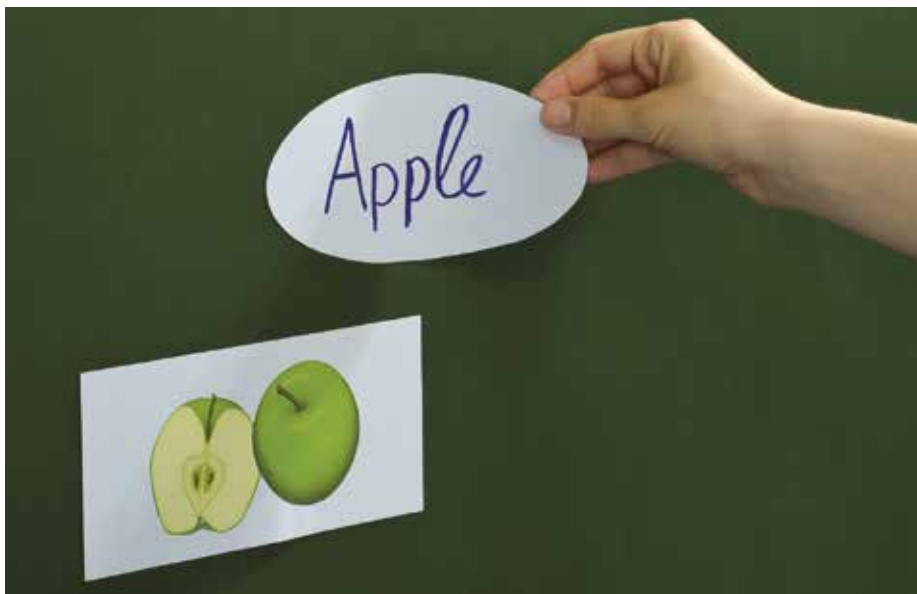

### Magnetic Paper

Realise your own teaching aids. This magnetic paper is writable and printable (with most inkjet printers). It is water and UV resistant and can easily be cut to desired size.

Set of 5 white sheets, A4, thickness 0.3 mm

**73499V90**

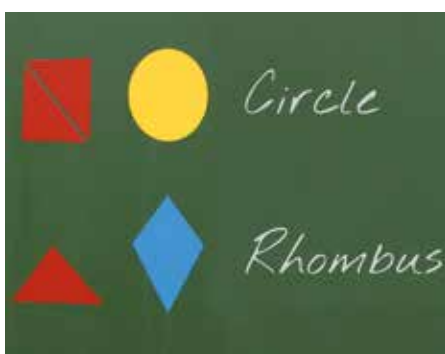

### Colourful Magnetic Sheets

Create your own magnetic material. Draw the artwork directly on the film and simply cut it out.

7 sheets, A4, thickness 0.7 mm, 7 colours

**73488V90**



**NEW**

**MAGNETIC**

**Chalk holder, magnetic, set of 4**

Keeps chalk dust away from hands and clothes. Integrated magnet enables to attach the holder to magnetic surfaces while not in use. Suitable for right- and left-handers.

Possible chalk diameter: 8 - 11 mm, 4 colours (red, green, yellow, blue), length: 9.5 cm, diameter: 2.2 cm, made from durable plastic

**761682V90**



**MAGNETIC**

**Classroom Jobs: Helpful Fox Magnets**

Students can easily copy their assignments from the board. The helpful fox magnets are ideal for use on a magnetic whiteboard but they can also be used on any other magnetic surface. Chores can be assigned in front of the class and the children learn to manage their tasks self-reliantly.

**Content:**

- 20 fox magnets (10 x 10 cm)
- 30 blank magnets with dry erase surface (3 x 10 cm)
- Set of instructions

**41330V90**

	Monday	Tuesday	Wednesday	Thursday	Friday
rubbish picker	Julia	Paul	Lenny	Mick	Simon
board cleaner	Susan	Kathy	Ella	Agnes	Luke
chair stacker	Chris	Pete	Rose	Tim	Bella
plant caretaker	Ben	Lea	Tiger	Leon	Laura
	Phil	Rick	Ringo	Andy	Eluis

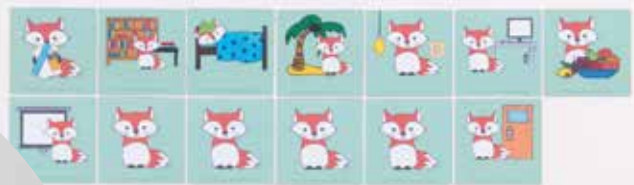

**MAGNETIC**

**Whiteboard Sheet**

The most simple and rapid way to install a flexible bulletin board is by using this self-adhesive magnetic whiteboard sheet. The surface is similar to a whiteboard, it is writable with whiteboard markers and dry-erased easily. Moreover, the surface is magnetic. Easy to apply anywhere: at the door, the blackboard, the wall. The self-adhesive backside nearly sticks to every kind of surface. Dimensions (W x H): 70 x 50 cm, Colour: white

**86606V90**

**BEST  
SELLER**



### Kid's Noise-Reduction Ear Muffs

In addition to minimizing noise, the headset also helps with concentration during silent work. Even during music lessons the headphones may protect against hearing damage, as well as in the free time, for example when visiting a concert.

Adapts to any head shape, for children with smaller heads and children or teenager with a slightly larger head. The lateral height adjustment can be adjusted quickly and easily. In addition, the earmuffs can be folded to save space and are so easy to stow. The headband is made of plastic and the ear protection cushion is made of imitation leather. Helps children to not be distracted by disturbing noises.

**758490V90** Blue

**758489V90** Green

**758491V90** Pink

**MAGNETIC**



### Magnetic Bookmarks, 5 pieces

These colourful bookmarks can easily be opened and clipped on the pages of a book or timetable. Due to its magnetic characteristics, the bookmarks won't get out of place. Moreover, they are extremely hard-wearing in contrast to normal paper bookmarks.

Tip: The bookmarks do not only mark pages, they can also be clipped on the vertical border to mark a line.

#### Content:

Set of 5 magnetic bookmarks (Dimensions: 2 x 6 cm in closed form)

**757005V90**

**MAGNETIC**



### Magnetic Picture Frames, 12 pieces in 6 colours

The picture frames resemble the design of polaroid-photos. Pin a photo to a magnetic wall by placing the frame over it. Useful tip: Inscribe the frames with whiteboard markers with names, information etc. Each picture frame additionally is equipped with 9 small magnets which can fix pictures in the frame or they can separately be used as small elements for decoration.

Dimensions (W x H):

› picture frame (outside): 11 x 13.2 cm

› inner cutting: 9.5 x 9.5 cm

› small magnet-motives: ca. 2.7 x 2.7 cm

Warning Notice: 43 (page 271)

**757332V90**

## Screen Printing Stamps

Screen printing stamps exclusively designed for teachers. Different motives. Red ink, no ink pad required. Non-refillable.

Diameter: 2.2 cm

All Warning Notice: 42 (page 271)

- 760136V90** King
- 760139V90** Thumb
- 760140V90** Smiley
- 760141V90** Sad face
- 760142V90** Smiley neutral
- 760143V90** Fox
- 760145V90** Bee
- 760146V90** Owl
- 760147V90** Monster
- 760148V90** Sad monster



- 760475V90** Stamps "faces", set of 3
- 760476V90** Teacher stamps, set of 10
- 760477V90** Stamps "animals", set of 3



## Reward Stickers

The reward stickers are perfectly appropriate to stick them into the folder or exercise book. Each set consists of 660 stickers.

- 757422V90** Colourful Smileys
- 757423V90** Colourful Stars
- 757874V90** Princesses and Knights
- 757873V90** Animals and Flowers
- 757872V90** English Monsters

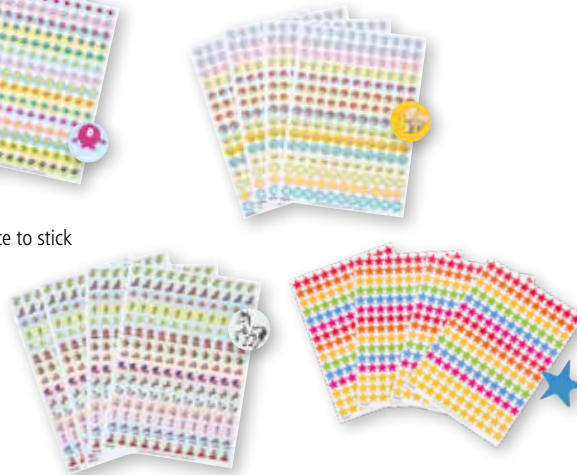

## Learning Pockets

The cover can be written on with dry erase markers. Slide the exercise in the pocket and you can start. Writing exercises, exercises to fill in, drawings ... After use the pockets can be cleaned with a sponge or a tissue. A set contains 10 pockets sealed with coloured tape.

- 87892V90** A4
- 755156V90** A3

# YOUR ADVANTAGES



**1** Innovative, new products for your market every year.



**2** Customer-focused team for your support.



**3** Very fast delivery and large stock of products to guarantee a high availability.



**4** Benefit from our longtime catalogue experience for your catalogue design.



**5** Individual product and logistic solutions complying to your needs.



**6** High-quality pictures for your marketing activities through our own photo studio.



**7** A loyal and reliable team for your support.



**8** Safe products for your customers guaranteed.



#### SPINLEY Turnable Disk

Turnable disk with 8 symbols to motivate and reward children and students. Usable for different occasions thanks to neutral symbols. Magnetic backside.

**Content:** 1 turnable disk  
Diameter: 15 cm

**759300V90**

#### SPINLEY Set of 660 Symbol Stickers/ Reward Stickers

Symbol stickers for rewarding children and students. Usable with or without the SPINLEY turnable disk.

**Content:** 660 stickers

**760213V90**

#### SPINLEY Set of 55 Blank Reward Cards

Blank cards for individual rewards for children and students. Symbol of the SPINLEY turnable disk on the front side, 3 lines for any inscription on the back side. Including case for easy storage.

**Content:** 55 cards, 1 transparent case  
Dimensions (H x W): 9 x 6 cm

**760215V90**



#### Quiver Case "Design"

Can be used as a pencil case or with the upper half turned over as a quiver. Sturdy material, with inner lining and firm base.

Dimensions (W x H): 13 x 19 cm

Material: 100% polyester

**760500V90**



#### Etui with Elastic Band

Practical sloppy folder with flexible elastic band for attachment to planners and notebooks. Suitable for A5, A4 and A4 plus. With zipper.

Dimensions (W x H): 7 x 22 cm

Material: 100% polyester

**760497V90** Design

**760498V90** Stripes







**Laminator Vision**

Our new Laminator Vision is an improved version of the Laminator AL3601.

Details:

- › Laminator for documents up to A3
- › For laminating foils up to 500 mic (total thickness)
- › Automatic adjustment to foil strength
- › Cold laminating is possible
- › 6 rollers
- › Short warm up time (approx. 60 sec.)

- › Laminating speed: 1200 mm/min (75 mic)
- › Automatic paper jam detection
- › Reverse function for safe use
- › Automatic standby mode
- › Power: 1200 W

**760915V90**



**Self-adhesive Pockets**

For the labelling of items, boxes or wardrobe compartments. Size per pocket:

- 758954V90** 18 pieces: 2.5 x 7.5 cm
- 758955V90** 9 pieces: 5.5 x 10.2 cm

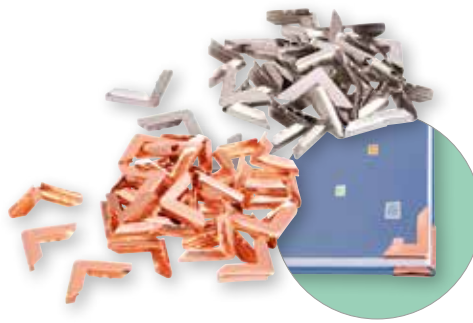

**Protective Book Corners**

Additional protection for the corners of calendars, planners and notebooks. 2 colours available. Set with 40 pieces. Material: metal

- 758911V90** Silver
- 758913V90** Rose-gold



**Triangle Pockets**

10 Self-adhesive triangle pockets, transparent. Ideal for notes, pictures and many more. Size per pocket: 17 x 17 cm

**758953V90**



**Laminating Pouches**

Super quality laminating pouches

Pack with 100 pouches	150 micron thickness (2 sides each 75 microns)	250 micron thickness (2 sides each 125 microns)
A5 (15.4 x 21.6 cm)	<b>74241V90</b>	<b>74242V90</b>
A4 (21.6 x 30.3 cm)	<b>74243V90</b>	<b>74244V90</b>
A3 (30.3 x 42.6 cm)	<b>74245V90</b>	<b>74246V90</b>





### Learning Box

If you need to memorise things, a learning box is a great way to do repetition. Using index cards and the box with 5 compartments you repeat only those things you do not know.

The box is completely open on the desk – the cover disappears on the underside of the box. The cards are sorted and stabilised by four variable, interlocking dividers. The learning box is small and compact. Dimensions (H x W x D): 6.6 x 20.5 x 9.6 cm

- 86331V90 Blue
- 86330V90 Red
- 757447V90 Yellow
- 757448V90 Orange
- 757445V90 Pink
- 757446V90 Green



### Box, Mini

Dimensions (H x W x D): 4 x 11 x 8 cm

- 74219V90
- 850143V90 Neutral

### Box, Small

Dimensions (H x W x D): 6 x 11 x 8 cm

- 74220V90
- 850144V90 Neutral

### Box, Medium

Dimensions (H x W x D): 7 x 19 x 15 cm

- 74221V90
- 850127V90 Neutral

### Box, Large

Dimensions (H x W x D): 11 x 26 x 18 cm

- 95095V90
- 850145V90 Neutral

### Storage Container 1,4 ltr

Practical storage container for office materials such as scissors, pens and paper clips. Easy to open. The plastic is food-safe so it's even possible to store food in the refrigerator. Use different colours to organise your classroom. Available in 7 different colours.

Dimensions (H x W x D): 7 x 19 x 15 cm

- 850138V90 Pink
- 850135V90 Orange
- 850136V90 Green
- 850132V90 Red
- 850139V90 Black
- 850133V90 Blue
- 850134V90 Yellow
- 756410V90 Set of 7

## Plastic with that 'Certain Something'

Our brand new Betzold treeNside material trays are filled with nature – you can see and even smell it! Test it out! They are produced in our own manufacture. We use organic plastic granulate made from wood fibres for their production. The materials are biobased. The robust treeNside material trays can be used in schools, kindergartens, in the office or at home. They are made for organising, storing and sorting or as a container for liquids, such as flourishing water or paste. We recommend the cleaning by hand with water and detergent.



### Sorting Trays, small, Set of 5

Dimensions (H x W x D): 2.6 x 18 x 12 cm  
**Content:** 5 material trays each per colour

- 758887V90 Nature
- 758888V90 Yellow
- 758889V90 Orange
- 758890V90 Red
- 758891V90 Pink
- 758892V90 Purple
- 758893V90 Blue
- 758894V90 Green



### Sorting Trays, large, Set of 5

Dimensions (H x W x D): 4.7 x 23 x 14.7 cm  
**Content:** 5 material trays each per colour

- 758897V90 Nature
- 758898V90 Yellow
- 758899V90 Orange
- 758900V90 Red
- 758901V90 Pink
- 758902V90 Purple
- 758903V90 Blue
- 758904V90 Green

With their wonderfully **harmonious colour combinations** the Betzold treeNside material trays draw everyone's attention. An organic plastic granulate made of wood fibre was processed here. Each bowl has **visible wood fibres** and also exudes a **soft, pleasant wood smell**.

### Sorting Trays

#### Set of 6 Small Sorting Trays in 6 Colours

850111V90 2.6 x 18 x 12 cm

#### Set of 6 Large Sorting Trays in 6 Colours

850112V90 4.7 x 23 x 14.7 cm



### Sorting Trays, small, Set of 6

Dimensions (H x W x D): 2.6 x 18 x 12 cm  
**Content:** 1x yellow, 1x orange, 1x red, 1x blue, 1x green and 1x yellow one of three colours of choice:

- 850255V90 Set with Nature
- 850272V90 Set with Pink
- 850274V90 Set with Purple



### Sorting Trays, large, Set of 6

Dimensions (H x W x D): 4.7 x 23 x 14.7 cm  
**Content:** 1x yellow, 1x orange, 1x red, 1x blue, 1x green and 1x yellow one of three colours of choice:

- 850253V90 Set with Nature
- 850273V90 Set with Pink
- 850275V90 Set with Purple



## Trays – Set of 5

These sturdy trays help to keep everything in perfect order when students work in groups. The trays are manufactured in Germany. They are made from food grade plastics and are also dishwasher-safe.

Dimensions (H x W x D): 2.6 x 18 x 12 cm  
**70883V90**





### Noise Control PRO

Enables selection of acceptable noise levels within classrooms, using the traffic light system. As noise levels increase, lights change from green to yellow then red with or without sound. Noise becomes visible for all children.

An adjustable sound level metre controls the decibel level. Table mount or wall brackets included.

Due to the rechargeable battery pack you are independent from cabling. The LED signal lights with a durability of about 100,000 power-on hours are ready for use at any place and any time. Thanks to rechargeable batteries (included) a continuous operation of 6 hours is possible.

Dimensions (H x W x D): 14.5 x 47 x 6.5 cm

**Content:** noise control, power supply, integrated charger and battery pack

**74747V90**

### Noise Control PRO without battery pack

**Content:** noise control, power adaptor

**74446V90**

### Battery pack for Noise Control PRO

**74748V90**

### Set of 4 Magnets

4 strong magnets enable to attach the noise control system to any metal surface.

**756744V90**



### Magnetic Emoticons & Discussion Icons

Use magnetic icons and emoticons to emphasise statements or keywords on whiteboards or other magnetic surfaces during discussions, pro-con-arguments or presentations.

The green check mark can help to tag a statement as correct. Highlight important issues with the magnetic index finger. Larger emoticons help to organise discussion panels or seatwork. The clock (writeable with dry erase marker) can be used to visualise the remaining time during seatwork or exams.

**Content:**

12x green check mark, 1x clock, 1x seatwork emoticon, 1x group work / discussion group emoticon, 4x thumb, 5x question mark, 5x exclamation mark, 5x star, 6x index finger, 7x flash, 8x neutral emoticon, 8x sad emoticon, 8x laughing emoticon, 8x blue arrow, 12x red cross

**74594V90**



### Multimedia HDMI Wall Plate

Simplify multimedia teaching! Projector, laptop computer and speakers can be used without complicated wiring. The wall plate can be installed without cutting expensive cable slots into the wall: All you need is a wall socket. An HDMI port provides high quality interconnection between all components. The plug & play front saves time during installation.  
 Connections: video, audio L & R (phono), VGA, power outlet  
 Cable length: each cable is approx. 10 m long  
 Power line: approx. 2.8 m  
 Dimensions (H x W x D): 15 x 20 x 6 cm  
**79490V90**

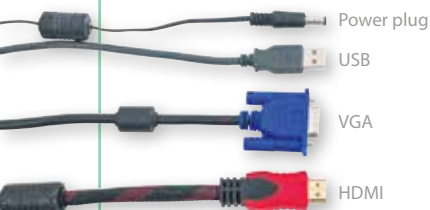

### The Gooseneck Visualiser

The Gooseneck Visualiser is the ideal tool for presentations, image capturing and video recording. With USB, VGA, HDMI multi-interface, not only works with any VGA, HDMI interface projector or monitor but also works with computer to capture real-time images of 3D objects, magazines, books, documents, pictures and business cards. Along with all these great features, the equipped software offers image editing capabilities and whiteboard tools.

**Max Scan Size:** A3 (420 x 297 mm)  
**Image Sensor:** 5.0 Megapixels CMOS  
**Resolution:** 2592 x 1944  
**Focus:** Auto focus  
**Microphone:** Built-in  
**Light Compensation:** Built-in highlight supplement LED  
**Interface:** USB output, VGA input, VGA out, HDMI output  
**Remote controller:** Infrared remote control  
**Flash memory:** Support maximum storage (external) 32G SD card  
**Power source:** Powered by AC adapter, DC 12V  
**Zoom:** 10x digital zoom for full HD presentation  
**Frame rate:** 30fps @ VGA and HDMI, 15fps @ USB  
**Output resolution:** 2592 x 1944 for USB; 720P, 1080P for VGA and HDMI  
**Picture Format:** MJPG  
**755511V90**



**MAGNETIC**

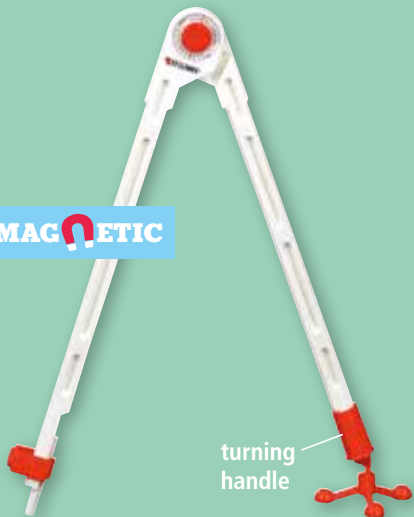

turning handle

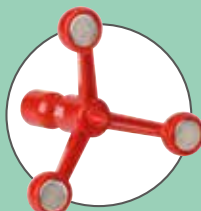

3 strong magnets



detailed scale

**GEOLINER**

### Board Compass "Power"

with magnetic clamps

The innovation among drawing appliances for blackboards: This compass has a magnetic foot with 3 strongly adhering magnets, which fix the compass to every magnetic blackboard.

Finally perfect circles and arcs are guaranteed!

Chalk can be clamped easily through a safe spring mechanism. Hence, slipping of the chalk is avoided.

Additionally the compass is equipped with a cm- and degree-scale. On one blade there is a turning handle installed that eases usage.

**420V90**

**GEOLINER**

### Board Compass "Classic"

with vacuum cups

The totally revised Geoliner blackboard compass will convince you by its superior quality and handling! With a super easy and safe mechanism you clamp the chalk into the compass. The vacuum cups are made out of extra soft synthetics, that easily adapt to rough blackboard surfaces. That way the compass adheres perfectly!

It also has a cm- and degree-scale, that enables you to draw perfect arcs and radiuses. On one of the 2 blades there is a turning handle installed that additionally eases usage.

**450V90**



turning handle



strong vacuum cups



detailed scale

**MAGNETIC**

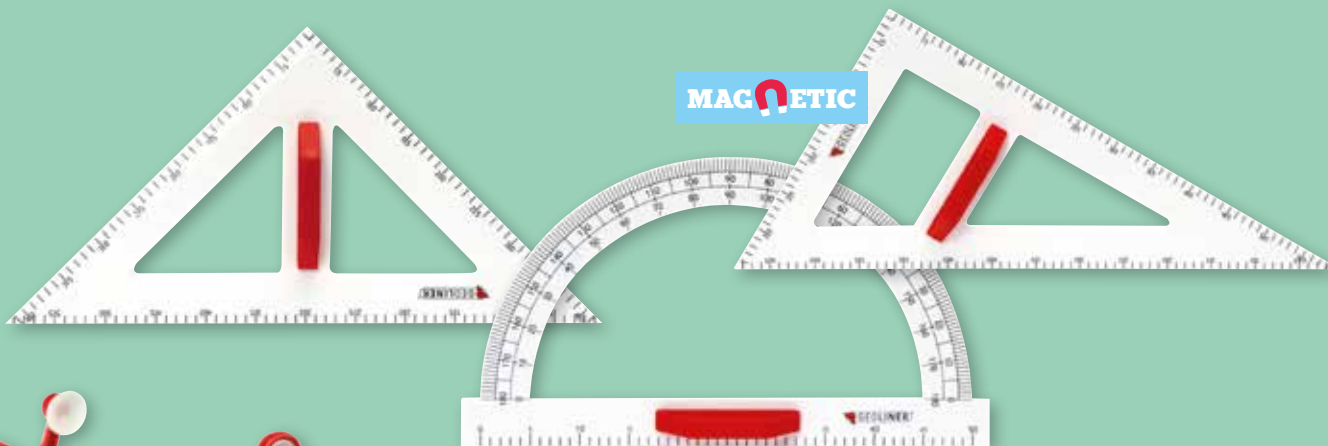

### Set Squares

**78111V90** 90° – 45° – 45°, 60 cm

**78950V90** With magnetic plates

**78112V90** 30° – 60° – 90°, 60 cm

**78951V90** With magnetic plates

### Protractor

**78113V90** 50 cm

**78952V90** With magnetic plates

**GEOLINER**

### Spare Parts

**292V90** Foot with 3 vacuum cups

**293V90** Foot with 3 magnetic cups

**306V90** Handle for geo square and ruler



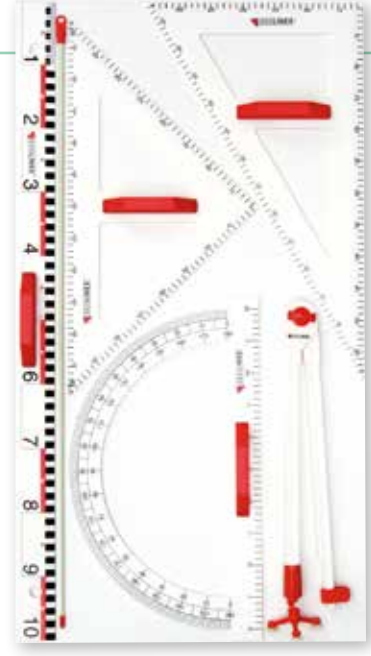
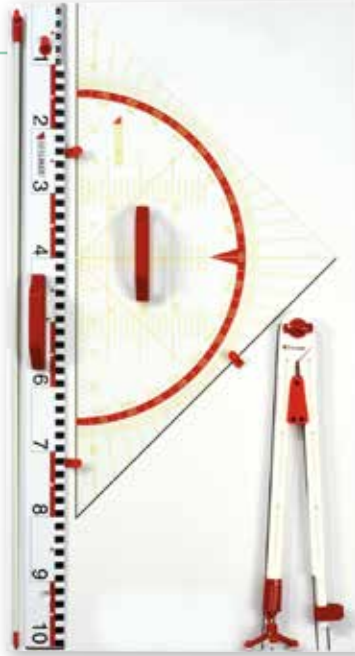
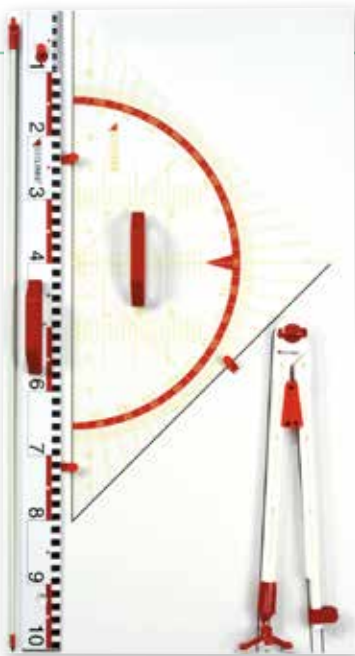

**Storage Board "Omega"**

**Content:**

- 1x compass "classic"
- 1x geo square
- 1x ruler
- 1x pointer
- and installation material

Dimensions (W x H): 55 x 101 cm

Omega II with 80 cm geo square

**77731V90**

**73825V90** magnetic ("Iota")



**Storage Board "Delta"**

**Content:**

- 1x compass "power"
- 1x geo square, 60 cm
- 1x ruler
- 1x pointer
- and installation material

Dimensions (W x H): 55 x 101 cm

Storage board delta with 60 cm geo square

**77728V90**

**73824V90** magnetic ("Zeta")



**Storage Board "Lambda"**

**Content:**

- 1x compass "classic"
- 1x set square (90° - 45° - 45°)
- 1x set square (30° - 60° - 90°)
- 1x protractor
- 1x ruler
- 1x pointer
- and installation material

Dimensions (W x H): 58.5 x 105 cm

Storage Board Lambda with set squares

**78118V90**

**73826V90** magnetic ("Beta")



**Geo Square**

- 294V90** Hypotenuse, 60 cm
- 302V90** With magnetic plates

- 295V90** Hypotenuse, 80 cm
- 303V90** With magnetic plates

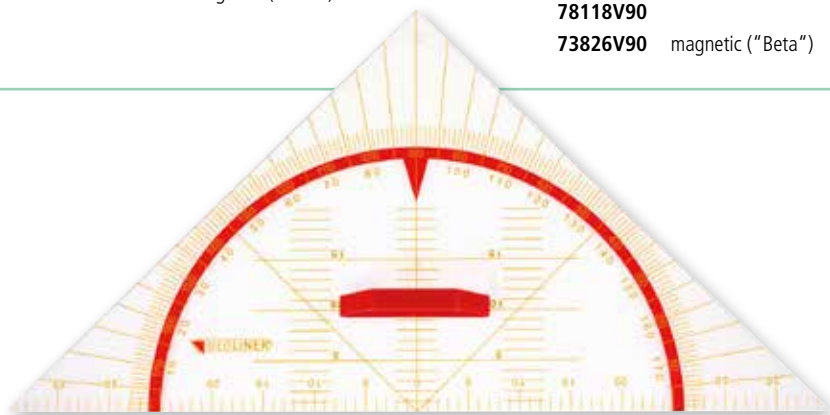

**Ruler**

100 cm, with cm and dm graduations

**307V90**



**Magnetic Ruler**

100 cm, with cm and dm graduations and magnetic plates

**77955V90**

# TLS® VoiceMaker-series



With USB & SD slot



## TLS® VoiceMaker Combi XL

Stereo box with MP3/CD-player, USB and cassette recorder  
 Stereo play back without additional loudspeaker!  
 Great output with mono sound recording mediums.  
 When Mono CDs or Mono Cassettes are played, the performance of both loudspeakers are summed up. The output is the same as when playing music. The ideal volume for classrooms as well as in larger school rooms can be regulated. The recorder is equipped with a three-digit tape counter. This box plays MP3 music files on CD or USB-Stick! Just plug in! Additionally CDs can be recorded directly onto USB-Stick.  
**Power output:** 2x 20 Watt  
**Microphone:** 6.3 mm jack  
**Headphones Stereo:** 6 x 3.5 mm jack  
**Cinch:** Cinch connector for external devices  
**Regulator:** Balance- and tone control treble/bass  
**Dimensions (H x W x D):** 23 x 42.5 x 25.5 cm  
**Weight:** 8.7 kg  
 USB-Port, SD card slot and Bluetooth  
**760384V90**

Item No.	Description	Power Output W	CD/MP3/USB/SD-Player	Cassette Recorder	Radio Receiver	Radio Microphone	Bluetooth	Accumulator	Trolley	Weight kg
760384V90	VoiceMaker Combi XL	20	✓	Stereo			✓			8.7
754602V90	M100 Combi	120	✓				✓		✓	16
754600V90	M100 Blue	120	✓		✓	1	✓		✓	16
754601V90	M100 Radio	120	✓	Stereo	✓	1	✓		✓	16
755203V90	M100 LS Plus	120								13.2
756271V90	M200 Blue	120	✓				✓	✓	✓	24
756272V90	M200 Radio	120	✓		✓	1	✓	✓	✓	24
756273V90	M200 Combi	120	✓	Stereo	✓	1	✓	✓	✓	24



## M100 Combi/Blue/Radio

Amplifier box with radio microphone.

Benefit from this professional technology – With 120 Watt power output even large halls can be filled with sound. M100 is the right choice whether for sport or music lessons, or ideal amplification for speeches and theatre plays. Including trolley for easy transport and

1 radio microphone (a second one can be added) with a range up to 30 metres.

MP3-data from USB or SD-cards can be played.

CD Player with pitch function and Gapless Player

AMS function = By using the microphone the music is subordinated

Integrated: USB-docking station and 3.5 mm AUX plug, remote-control

### Technical data:

**Power Output:** 120 Watt music

**Loudspeaker:** Two way system, treble / bass loudspeaker

**Input/Output:** 2x 6.3 mm jack for microphones, 1x for LS 100 Active Box, 1x cinch for external devices (Keyboards, stereo system, PC-Soundcard), 1x 6.3 mm jack for headphones, Bluetoothinterface, USB-docking station for recharging Smartphone & Co

**Cassette recorder:** Tape counter, 3-digit

**Dimensions (H x W x D):** 58 x 33 x 29 cm

**Weight:** 16.4 kg

### 754602V90 M100 Combi



### 754600V90 M100 Blue

Settings same as 754602V90, however without wireless microphone and cassette



### 754601V90 M100 Radio

Incl. radio microphone, Settings same as 754602V90, however without cassette deck



## High quality and absolute reliability

TLS and its model series M100 stands for absolute reliability and maximum quality. The models M100 Blue, M100 Funk and the top-of-the-line model M100 Combi impress by perfect sound and high-quality finishing. Solide wooden bodies guarantee an absolute top-class sound experience. The sound boxes offer

different options to play your sound files: CD, MP3, SD card, USB, AUX and Bluetooth. This enables you to use your smartphone or tablet, which provides the highest possible flexibility. The boxes offer a safe with a lock so you can store your devices securely while not in use. The models differ in the following equipment: The M100

Blue has Bluetooth and a CD drive. In addition, the M100 Funk has a built-in radio receiver for the enclosed radio microphone. The M100 Combi also has a cassette drive with pitch function and counter.

The flap provides a secure stand for tablets (not included).



including AUX-IN and charging station in the device safe



sturdy lock and metal flap for safe storage

# TLS® M200 – series with battery model

## Lockable storage compartment

Store your valuable devices safely. You will find the remote control in the compartment on delivery.

## USB + AUX-IN

The USB port ensures the battery of your mobile device to be fully charged at any time. A fast and satisfactory music performance is possible due to the AUX jack.

## Bluetooth

For all models of your TLS®-Box, Bluetooth function counts to is part of the basic configuration. (Smart-phones and tablet computers)

With second built-in receiver modul for an additional wireless microphone (page 270)

## Battery

The battery provides full power for up to 4 hours.

## Trolley with rollers

Movable for flexible use:

- > gymnasium
- > hall
- > schoolyard



## M200 Blue/Radio/Combi

### Technical details:

**Amplifier:** 120 watt music

**Speakers:** 2-way-system, woofer and tweeter

**In-/Outputs:** 2x 6.3 mm jack for microphones, 1x 3.5 mm jack AUX-IN, Bluetooth-Interface, 1x 6.3 mm jack for LS 100 Active box, 1x Cinch-In-/Output for external sources (keyboard, stereo, PC sound card), 1x 6.3 mm jack for headphones, USB charging station for the charging of smartphones etc.

**Tape recorder:** Tape drive, 3 digits

**Dimensions (H x W x D), weight:** 58 x 33 x 29 cm, 16.4 kg

**Scope of delivery:** wireless microphone, power cable, remote control (incl. batteries)  
Tablet computer not included!

AVAILABLE IN  
3 VERSIONS

### 756271V90 TLS® M200 Blue



### 756272V90 TLS® M200 Radio



### 756273V90 TLS® M200 Combi





### M100 LS PLUS Active-Loudspeaker

Especially for the Amplifier-Box M100 and M100 radio  
The output power of 120 Watt (music) adds up to the  
output power of the recorder and CD-amplifier boxes.  
A successful use is definitely possible by larger events.  
Best stereo playback is performed together with the  
M100 Combi

#### Technical data:

**Amplifier:** 120 Watt music

**Loudspeaker:** Two way system, treble / bass loudspeaker

**Dimensions (H x W x D):** 51 x 33 x 29 cm

**Weight:** 13.2 kg

With 8 m connector cable

**755203V90**

### Microphone Stand

With cantilever arm, footstep sound insulated, thread  
16 mm (5/8") and 9 mm (3/8").

Height-adjustable from 95 to 210 cm

Colour: Black

Cantilever: 72 cm

Weight: 2 kg

**74184V90**



### Universal tripod incl. Adapter

Tripod made of sturdy aluminum tubes with a diameter of  
3,5 cm. The height can be adjusted from 100 to  
180 cm. By removing the adapter piece the tripod can be  
used for all TLS® M-series and Comprá® Sound Box 9995.  
(Tube diameter either 2.5 cm (Comprá®) or 3.5 cm (TLS®).)  
Tripod is secured by using thumbscrews and a metal pin,  
which also secures the height adjustment. This guarantees  
an ideal and safe stand of your amplifier boxes.

The maximum carrying weight is 50 kg.

**74932V90**



- > BATTERIES WITH UP TO 5 HOURS OPERATING TIME
- > CD-PLAYER
- > USB JACK
- > SD CARD SLOT
- > 2 RADIO MICROPHONES
- > INTEGRATED TROLLEY



clear control panel



Storage for microphones and remote control



Many connections for external devices such as loudspeakers



### SoundBox 9995 Funk

The ideal device for schools!

With the different connection possibilities, for example USB and SD as well as battery operating function the SoundBox is a real multi-talent! Thanks to battery operation you can use the box without power-sockets, for example at outdoor events or on sports fields.

The SoundBox has 100 Watt performance and is suitable for classrooms as well as halls.

The radio microphone receiver is built into the plastic housing. The microphone volume is regulated separately. A third microphone can be additionally connected.

Cable, microphone and additional accessories can be stored in the practical compartment above the CD-Player. This way nothing is lost.

#### Technical data:

**Amplifier:** 100 Watt music

**CD-Player:** CD/MP3, CD-RW

**Input/Output:** 6.3 mm jack for microphone, 2x 6.3 mm jack for external loudspeakers, AUX in and out, video-cinch, USB, SD card slot

**Microphones:** 2x UHF radio microphone (registration- and charge-free)

Dimensions (H x W x D): 60 x 30 x 29 cm

**Weight:** approx. 17.6 kg

**Others:** USB-jack, SD card slot, remote control, instruction manual, battery operated with charger indicator

**79790V90**



### Acoustic Speaker System 9995

The Compra® Acoustic Speaker System 9995 is an all-in-one package for your event.

The Compra® Soundbox 9995 is equipped with many different connections for playback sources such as Bluetooth, USB or CD. The additional loudspeaker can easily and quickly be connected to the main box via a 6.3 mm jack speaker cable. The included microphone allows for lectures or even music to be played to a larger audience. By using the tripods, the sound can be transported over longer distances to the very end of the hall.

#### Technical data:

- › **Amplifier:** 100 watts of music power
- › **CD player:** CD/MP3, CD-RW
- › **microphones:** 2x UHF wireless microphone (863–865 MHz, registration free)
- › **Weight:** approx. 17.6 kg
- › **Dimensions (H x W x D):** 60 x 30 x 29 cm
- › incl. remote control
- › Battery operation with charge status indicator
- › **inputs and outputs:**
  - › 6.3 mm jack for micro
  - › 2x 6.3 mm jack for external speakers
  - › AUX in and out
  - › Video cinch
  - › USB
  - › SD card reader

**754840V90**



#### Speaker Cable

2x 6.3 mm jacks, length: 10 m

**78983V90**



#### Universal Auxiliary Speaker

Exceptional stereo sound. Connectable with any amplifier box. 6.3 mm jack output necessary! Improves output by 100 watt. Speaker cable not included.

**78873V90**



#### Stand for Auxiliary Speaker

Height-adjustable (75 - 105 cm). Robust aluminium tubes, diameter: 1.5 cm  
With 2 wing screws and metal pin for secure hold.  
Delivery without auxiliary speakers.

**78968V90**



**NEW**



**TLS Handheld Microphone**

The microphone is lightweight and handy. It is suitable for the sound boxes TLS M100 Radio and Combi and for TLS M200 Funk and Combi. No additional settings required. Operates in the public band.

**760930V90** 863,05 MHz  
**756302V90** 864,8 MHz

**Microphone (wireless)**

For all TLS® Boxes with integrated radio transmitter. Cardioid characteristic. Channel selectable. Frequency range 863–865 MHz. Scope of delivery includes batteries for pocket transmitter. (2x type AA Mignon LR6)

**74187V90**



**Dynamic Microphone DM 70**

Cardioid characteristic, 3 m cable with 6.3 mm jack, On-/Off-switch, without stand clamp.

**8121V90**

**Headset Microphone including Pocket Transmitter**

For all TLS® Boxes with integrated radio receiver. Cardioid characteristic. Channel selectable. Frequency range 863–865 MHz. Scope of delivery includes batteries for pocket transmitter. (2x type AA Mignon LR6)

**74191V90**



**Clip-on Microphone including Pocket Transmitter**

For all TLS® Boxes with integrated radio receiver. Cardioid characteristic. Channel selectable. Frequency range 863–865 MHz. Scope of delivery includes batteries for pocket transmitter. (2x type AA Mignon LR6)

**74195V90**

**Wireless Microphone Head Strap**

Settings same as 74191V90 however with 2-channel-receiver for music boxes without integrated receiver. Input 6.3 mm jack.

**74193V90**

**Wireless Clip-on Microphone**

Settings same as 74195V90 however with 2-channel-receiver for music boxes without integrated receiver. Input 6.3 mm jack.

**74196V90**



**Clip-on Microphone incl. Pocket Transmitter**

Compatible with the TLS® amplifier box M100/200  
**761026V90**



**Headset Microphone incl. Pocket Transmitter**

Connection between bodypack and microphone: XLR Pin Plug  
**761027V90**



**Professional Headset Microphone incl. Pocket Transmitter**

Compatible with the TLS® amplifier box M100/200  
**761028V90**



# About Toy Safety:

For us toy safety is more than only providing an EN 71 certificate – we believe in responsibility for our products. Our QC team with three colleagues is checking all of our products and not only the toys. One of these colleagues is an approved “specialist for toy safety” and another one is our technician and quality inspector.

We use the Toy-Checker technology for a permanent screening of our products. The Toy-Checker can identify toxic elements which are banned for example by EN 71 part 3.

For all our toys we can provide an EC-Declaration of Conformity on demand. For non-toy products we can provide statements which explain why these products are not considered as toys and which other regulations they comply to.

Also for all our toy products you will find the appropriate toy warning notices in our catalogue.



## Warning Notices

- 1 WARNING! Not suitable for children under 3 years of age due to small parts. Danger of suffocation!
- 2 WARNING! To be used under the direct supervision of an adult.
- 3 WARNING! Not suitable for children under 3 years of age - possible risk of falling!
- 4 WARNING! Not suitable for children under 3 years of age. Strangling hazard! Long Cord.
- 5 WARNING! Not suitable for children under 3 years of age due to small balls. Danger of suffocation!
- 6 WARNING! Choking Hazard! - Children under 8 years can choke or suffocate or uninflated of broken balloons. Adult supervision required. Keep uninflated balloons from children. Discard broken balloons at once.
- 7 WARNING! Not suitable for children under the age of 3 years- Functional sharp points and/or sharp edges - risk of injury!
- 8 WARNING! This toy does not provide protection - Possible risk of injury!
- 9 Notice: Please supervise the usage of the arts and craftsworks!
- 10 Notice: Functional Arts & Crafts tools. Possible risk of injury. No toy in terms of the Toy Safety Directory. Children under 14 years need to be supervised by an Adult.
- 11 WARNING! Not suitable for children under 10 months. Long hair.
- 12 Notice: Adult assembling required. Contains small parts. Choking hazard!
- 13 WARNING! Do not allow children to climb onto the product. Not enough stability.
- 14 WARNING! Keep away from fire.
- 15 Notice: Do not use in traffic, near steps, escalators, platforms, pools or sloping streets. Do not operate with high speed.
- 16 WARNING! Not suitable for children under 18 months of age. Choking hazard! Small parts.
- 17 WARNING! Protective equipment should be worn. Not to be used in traffic.
- 18 Notice: Dekorating item. Not suitable for playing. Detachable small parts. Choking hazard.
- 19 WARNING! Not suitable for children under 3 years of age. Choking hazard! Small parts/small balls. Not to be aimed at persons or animals. Possible risk of injury by recoiling projectiles. Only use balls provided with this game.
- 20 Notice: Play kitchenware, tableware or sometimes made out of plastic and or not suitable to be used for cooking. Do not heat them on the stove, oven or in the microwave. Plastic parts can melt. Wash all parts that come in contact with food with dishwashing detergent before usage.
- 21 Notice: Key chain. Not a toy.
- 22 Notice: Sports- and Playing equipment. Warning! For using this item it is assumed that the user possesses certain motor-driven skills and cautiousness. In case of doubt use with assistance in the beginning.
- 23 WARNING! Not suitable for children under 3 years of age - possible danger of hurting the fingers due to the presence of wheels!
- 24 WARNING! Do not use near high voltage power lines or by storm.
- 25 WARNING! Only to be used in water in which the child is within its depth and under adult supervision.
- 26 WARNING! Children under the age of 3 years should be supervised by an adult. Possible danger of falling!
- 27 WARNING! Not suitable for children under 36 months. Do not aim at eyes, face or animals. Possible risk of injury by ricocheting projectiles!
- 28 WARNING! Not to be used by children over 3 years of age. No sufficient stability. Not equipped with a braking mechanism.
- 29 WARNING! Not suitable for children under 18 months. Long cord/ long chain. Strangulation hazard! " Please retain this information for future referenced.
- 30 Notice: Never burn tea lights/candles near or on flammable objects (flammable liquids, gasses or flammable powders). Never burn candles within reach of children or animals.
- 31 WARNING! Does not provide any protection against drowning. Only to be used under adult supervision!
- 32 WARNING! Not suitable for children under the age of 8 years. This product contains a magnet. Swallowed magnets can stick together in the Intestines and cause severe injuries. Seek immediate medical help if the magnet is swallowed.
- 33 WARNING! To be used by only one person. Risk of collision!
- 34 WARNING! Magnifying effect - do not look directly into the sun!
- 35 WARNING! Not suitable for children under 12 months. Thrusting risk due to protruding parts!
- 36 Notice: The user of this model should be a steady bicycle rider and watch out for steady underground in the beginning.
- 37 WARNING! Only to be used by children of 10 years and older as electrical parts are accessible.
- 38 WARNING! Not suitable for children under 3 years of age. Protruding parts - impact hazard.
- 39 WARNING! No climbing element - to be used under adult supervision!
- 40 Notice: Do not fasten ropes, scarves etc. on the poles/openings. Strangling hazard.
- 41 WARNING! THIS IS NOT A TOY - TEACHING AID! Adult supervision is required. Seek immediate medical help when liquid inside the thermometer is swallowed.
- 42 Notice: Educational material - to be used under the direct supervision of an adult.
- 43 Notice: To be used under the direct supervision of an adult. Small parts.
- 44 WARNING! Not suitable for children under 8 years of age. Instructions are included and have to be followed under all circumstances.
- 45 WARNING! To avoid allergic reactions test the cosmetics on a small skin area firstly (crook of the arm). Should this cause any skin irritation, do not use cosmetics. For external use only.
- 46 WARNING! This toy is not equipped with a braking system.
- 47 WARNING! Sports equipment - Only children with weight above 20 kgs are allowed to use the equipment. It is recommended to use a helmet and protective vest.
- 48 WARNING! Not suitable for children under 3 years of age. Shear and pinch hazards.
- 49 Notice: This product can be used by children under 3 years for learning purposes. The children must be supervised by an adult at all times. Warning! Choking hazard. Contains small parts.
- 50 WARNING! Not suitable for children under 8 years. Contains plaster powder. Do not put into the mouth or apply on the skin. Plaster powder can irritate eyes, nose and throat. To be used under adult supervision.
- 51 WARNING! Not suitable for children under the age of 3. Small children are not able to control the snow slider. The supervision of an adult is required. Protective equipment is recommended (helmet, protectors, solid footwear, gloves). Consider others. Pay attention to obstacles.
- 52 WARNING! Not suitable for children under the age of 3. Strangling hazard - long cord. Only to be used on leveled grounds. It is not allowed to use the item near or on playground equipments (for example slides, swings, playground climbing frames, climbing houses or other playground equipments) as well as trees. Adult supervision is required.
- 53 WARNING! No buoyancy aid, no protection against drowning, not suitable for non-swimmers. Device can only be used by practiced swimmers. Adult supervision is required.
- 54 WARNING! Not to be used by children over 3 years of age due to the construction of product.
- 55 WARNING! Not suitable for children under 4 years of age. Small parts. Choking hazard.
- 57 WARNING! Do not use close to the ear. Misuse may cause damage to hearing.

# PREMIUM QUALITY - MANUFACTURED IN GERMANY

Our parent company **Betzold** manufactures high end plastic products, toys and furniture in **own factories** in Germany.

Production in Germany helps us to comply with the **highest Toy-Safety standards**. To guarantee quality we only use Toy-certified plastic granules as raw material.

Intensive quality inspection complying with high German standards is done during the manufacturing process.

Also production in Europe is sustainable. We avoid long transports and strengthen our local economy.

Due to savings for transport and highly automated production we also can offer these products for a very reasonable price.

Identify these products by looking out for:



**Bright and stable colours guaranteed**



**Premium raw material**



**High level quality inspection**



## Useful Plastic Storage Organiser Boxes – made in Germany

The colourful storage boxes are small, measuring 4 x 10.5 x 7.7 cm (H x W x D), or 6 x 10.5 x 7.7 cm (H x W x D) but can hold a lot of different bits and pieces. As they are stackable, you could have them stacked in a drawer or kitchen cupboard. As they come in 9 different colours, you can even colour code them!  
Heavy duty: The boxes feature lock clips on the front and back of the box to keep the small pieces inside safe. Even if they are tipped upside down, the clips will hold the box closed. As the boxes are sturdy and strong, they will last you years to come.  
Bright colours, different sizes: The boxes come in 6 different colours and 2 different sizes

## PRODUCTS MADE IN GERMANY



### Cone with Holes

Very sturdy plastic. Height: 30 cm  
Can be used in conjunction with the hoops and the poles.

- 850101V90** Green
- 850100V90** Blue
- 850099V90** Pink
- 850098V90** Orange
- 33426V90** Red
- 33427V90** Yellow

### Storage Box Mini, 200 ml

- 850240V90** Blue
- 850242V90** Green
- 850245V90** Red
- 850243V90** Orange
- 850244V90** Pink
- 850241V90** Yellow

### Storage Box Small, 300 ml

- 850246V90** Blue
- 850248V90** Green
- 850251V90** Red
- 850249V90** Orange
- 850250V90** Pink
- 850247V90** Yellow

### Sorting Trays

#### Set of 6 Small Sorting Trays in 6 Colours

**850111V90** 2.6 x 18 x 12 cm

#### Set of 6 Large Sorting Trays in 6 Colours

**850112V90** 4.7 x 23 x 14.7 cm







### Sorting Trays, small, Set of 5

Dimensions (H x W x D): 2.6 x 18 x 12 cm

**Content:** 5 material trays each per colour



- |                         |                         |
|-------------------------|-------------------------|
| <b>758887V90</b> Nature | <b>758891V90</b> Pink   |
| <b>758888V90</b> Yellow | <b>758892V90</b> Purple |
| <b>758889V90</b> Orange | <b>758893V90</b> Blue   |
| <b>758890V90</b> Red    | <b>758894V90</b> Green  |

**850255V90** Set of 6  
(nature, yellow, orange, red, blue, green)

**NEW**



### Cup Quizzer

Cup made from sustainable biopolymer.

Suitable for sorting games, as a rewarding system or as voting box.

**Content:** 1 cup in the selected colour

Measurements (H x W x D): 8 x 8.7 x 6.2 cm, Material: biopolymer

**850289V90** Blue

**850292V90** Red

**850291V90** Green



**treeNside – contains a lot of nature.**

Material trays made from selected wooden bio plastic granulate. This material is biobased and only uses minimal fossil resources.

### The most important details at a glance:

- produced in our own plastic manufacture
- wooden bio plastic granulate – you can see and even smell it!
- made from renewable raw materials, only using minimal fossil resources
- short transport routes at procurement and production



### Pencil Holders, Set of 5, different colours

Ideal for sorting and organising. Made from solid, sustainable treeNside material (bioplastics) that is made from fine wooden fibres. Set consists of 5 pencil holders in five colours (blue, green, yellow, orange, red).

Dimensions per pencil holder (H x W x D): 8 x 8.7 x 6.2 cm

**761918V90** Set of 5



### Storage Tower, 4 Large Drawers

Use this tower as the perfect extension for cabinets and shelves or as the super flexible mobile organiser. The drawers are made from sustainable treeNside material (bioplastics). This material consists of fine wooden fibres. Drawers are stackable. The tower includes castors for mobility. It is up to you to create a freestanding tower, a cabinet storage or a roller container.

Dimensions (H x W x D): 86 x 30 x 38 cm

**850322V90 + colour (page 230)**



**NEW**



### Can Stilts, Set of 3 (blue, red, yellow)

For games and races of sports and fun. Support the motor activity of the kids with balance and craft exercises. Made from solid, sustainable treeNside material (bioplastics) that is made from fine wooden fibres with tear-proof holding rope. Set consists of 3 pairs of can stilts in 3 colours (blue, red, yellow).

Dimensions: height: 12 cm, diameter: 9.5 cm

Warning Notices: 3, 4 (page 271)

**761625V90** Set of 3

# DO YOU HAVE ANY QUESTIONS?

## HOW TO CONTACT US

### OUR ADDRESS:

**Betzold Educational GmbH**  
Ferdinand-Porsche-Str. 6  
73479 Ellwangen  
Germany

### PHONE:

+49 7961 - 9258 - 10

### FAX:

+49 7961 - 9258 - 20

### E-MAIL:

info@betzold-educational.com

### WEBSITE:

www.betzold-educational.com

### YOU CAN ORDER BY:

› letter  
› fax  
› e-mail  
› telephone  
(Monday to Thursday between 8.00 am and 4.30 pm.  
Friday between 8.00 am and 2.00 pm.)

### YOU RECEIVE YOUR GOODS:

We deliver ex works (Exw.) from our warehouse in 73479 Ellwangen. Should you wish, we can organise the transportation at your own cost. Of course we will inform you in advance about the charges.

### IS THERE A MINIMUM VALUE FOR AN ORDER?

We suggest a minimum order value of 400 €.

### WHAT ABOUT THE PRICE?

VAT will be added to the prices if you do not indicate your VAT Number. There are no packing costs to be paid. You will be charged for the delivery costs incurred, should you wish, we can organise the transportation.

### HOW CAN YOU PAY?

For the first year or minimum 5 orders we prefer payment in advance:  
› Cash remittance  
› Letter of credit

### OUR BANK ACCOUNT IS:

Bank: VR-Bank Ellwangen  
IBAN: DE 88 61491010 00238909000  
BIC: GENODES1ELL

### IF YOU HAVE A PROBLEM:

Contact us directly by phone. We will find a satisfying solution for you.

### HOW LONG DOES THE DELIVERY TAKE?

We deliver as fast as possible! However, it is possible that a delivery may be delayed or an article is in higher demand than anticipated. Under these circumstances we will inform you at once about the estimated date of delivery.

Should something have annoyed you or somebody made a mistake or you think we could improve our service or you have a very special request – just give us a call, we are here for you!

### AND FINALLY:

**By the way, please also let us know, if you are satisfied with us and our service – that's always the best motivation!**

# YOUR ADVANTAGES

- > INNOVATIVE, NEW PRODUCTS FOR YOUR MARKET EVERY YEAR.
- > CUSTOMER-FOCUSED TEAM FOR YOUR SUPPORT.
- > VERY FAST DELIVERY AND LARGE STOCK OF PRODUCTS TO GUARANTEE A HIGH AVAILABILITY.
- > BENEFIT FROM OUR LONGTIME CATALOGUE EXPERIENCE FOR YOUR CATALOGUE DESIGN.
- > INDIVIDUAL PRODUCT AND LOGISTIC SOLUTIONS COMPLYING TO YOUR NEEDS.
- > HIGH-QUALITY PICTURES FOR YOUR MARKETING ACTIVITIES THROUGH OUR OWN PHOTO STUDIO.
- > A LOYAL AND RELIABLE TEAM FOR YOUR SUPPORT.
- > SAFE PRODUCTS FOR YOUR CUSTOMERS GUARANTEED.

MORE ABOUT US:

[WWW.BETZOLD-EDUCATIONAL.COM](http://WWW.BETZOLD-EDUCATIONAL.COM)





**Rainbow**  
details page 7

INSPIRATION IN EDUCATION

 **Betzold**

**Betzold Educational GmbH**  
Ferdinand-Porsche-Str. 6  
73479 Ellwangen  
Germany

phone: +49 7961 - 9258 - 10  
fax: +49 7961 - 9258 - 20  
[www.betzold-educational.com](http://www.betzold-educational.com)  
[info@betzold-educational.com](mailto:info@betzold-educational.com)